



OFFICE OF
**RESOURCES
AND ALUMNI**

Indian Institute of Technology Kanpur

**ANNUAL
REPORT
2024-25**





ANNUAL REPORT

2024 - 25

**Dean of Resources and
Alumni Office**

Indian Institute of Technology Kanpur

CONTENTS

Dean's Message	5
Alumni Hall of Fame	6
Awards and Recognition	17
Giving Back	23
Outreach Activities	91
Project Initiatives	111
Campaigns and Memorial Funds	130
Students' Initiatives	134
Infrastructure initiatives	158
CSR	166
Educational Initiatives	181
Batch Initiatives	190
Community Welfare	193
Research Support	206
New Initiatives	213
Annexure	221

DEAN'S MESSAGE



PROF. AMEY KARKARE

**Dean of Resources and Alumni,
IIT Kanpur**

It is with immense gratitude and pride that I share this year's Annual Report with you. The past year has been extraordinary—not only in terms of achievements but also in the strength of connection and support we have witnessed from you, our valued alumni. Your unwavering commitment to the Institute continues to inspire and drive us forward.

Thanks to your generosity, we received an outstanding ₹159.70 crore in donations during the year, against ₹265.24 crore pledged. These contributions are already making a significant difference—enhancing student support, empowering faculty, and enabling strategic initiatives across the Institute. From the generous pledges made by the Classes of 1999, 1980, 1975, 1985, and 1965 to the impactful support from corporate partners like IBM India Pvt. Ltd., each gift carries a vision for a stronger, more inclusive, and forward-looking IIT.

This year, we introduced several new initiatives, all made possible through your support. These include 20 scholarships, 13 awards, 4 faculty chairs, 2 fellowships, 2 departmental funds, 6 campaign and memorial funds, and 2 distinguished lecture series. A particularly meaningful addition is The Humanities–Technology Bridge—a program launched in tribute to Prof. Mahajan and Prof. Dhanagare, exemplifying the spirit of interdisciplinary learning.

Equally heartening was the participation in alumni reunions. We were delighted to host ten alumni reunions, each reflecting the deep and lasting connection our graduates share with IIT Kanpur. A particularly special highlight was the reunion of the institute's first graduating class—the Class of 1960—marking a historic moment in our legacy. From the 60th reunions of the early batches to the 10th reunion of more recent graduates, these gatherings brought together alumni across decades, rekindling cherished memories and renewing their sense of belonging to their alma mater.

On the innovation front, the Institute reached new heights—filing 156 IPRs (our highest ever), including Indian and international patents, copyrights, and trademarks. We also successfully licensed six technologies. These achievements underscore IIT's growing leadership in translating research into real-world applications.

We were also proud to celebrate the accomplishments of our alumni and faculty who received some of the world's most prestigious honors this year—from the Wolf Prize in Physics to the Padma Shri and top disciplinary accolades like the NAS election, Knuth Prize, PECASE, and IEEE/ACM fellowships.

As we look ahead, we are energized by your continued engagement and belief in our mission. Your support is a testament to a shared legacy and a collective dream. On behalf of the entire team, I extend my heartfelt thanks to each one of you for your generosity, time, and trust.

Yours sincerely

A handwritten signature in black ink that reads "Amey Karkare".

Prof. Amey Karkare

ALUMNI HALL OF FAME

IIT Kanpur proudly celebrates its exceptional alumni, whose groundbreaking contributions span industries, academia, research, and entrepreneurship. Every year, on Foundation Day, November 02, the institute honors distinguished alumni with prestigious awards, recognizing their excellence in innovation, leadership, and societal impact. These awards celebrate trailblazers shaping technology, science, and business, reinforcing IIT Kanpur's legacy of nurturing world-class leaders. The alumni network continues to inspire future generations, upholding the institute's tradition of excellence.

DISTINGUISHED ALUMNI AWARD 2024



Shri Harsh Kumar
(BT/ME/1973)

Shri Harsh Kumar is the President & Co-Founder of Niswarth (organization that focuses on empowering underprivileged and specially-abled individuals, particularly in North Bengal and Assam) and a veteran leader in the North Bengal tea industry with over 51 years of experience. A Mechanical Engineering graduate from IIT Kanpur (1973), he has held pivotal roles including Executive Director of Teesta River Beverages, CEO of Hind Tea Company, and is currently the Visiting Agent at Contemporary Brokers Pvt. Ltd, where he manages key operations, improves tea estates, and leads major plantation projects. Beyond his professional achievements, Shri Kumar is deeply committed to social service. In 2006, he co-founded the NGO Niswarth with his wife, delivering healthcare, disability certification, vocational training, and community development across North Bengal, Assam, impacting 273 tea gardens and benefiting over 1.57 million people. He has served as Chairman and Vice Chairman of the Indian Tea Association (Dooars) and continues to advise various tea estates and institutions. His leadership integrates technical excellence with a passion for uplifting underprivileged communities, especially in rural and tribal regions.

Shri Shashidhar Sinha, has over 38 years of experience in the advertising industry in India and is currently the CEO of IPG Mediabrands India, the second-largest advertising and media buying group in the country. Under his leadership, IPG Mediabrands climbed from outside the top five to the second position, achieving a remarkable revenue growth CAGR of over 19% in the last decade. The group serves more than 150 clients, including Amazon, Samsung, Amul, Tata Motors, and ITC. Beyond his role at IPG, Shri Shashidhar has made significant contributions to the advertising and media industry. He is the Chairman of the Board of the Broadcast Audience Research Council (BARC), which runs the world's largest TV audience measurement panel. Shri Shashidhar also served as the Chairman of the Media Research Users Council (MRUC), which oversees the Indian Readership Survey—the world's largest readership survey.

He is uniquely positioned as the only individual to have headed both television and print audience measurement bodies in India. A civil engineering graduate from the class of 1979, Shri Shashidhar's influence extends to numerous boards, including Dainik Jagran, IIM Amritsar, and advisory roles at IIM Bangalore. He also dedicates time to social causes, supporting organizations like Akhand Jyoti Hospital, which works on eradicating blindness in Bihar, and TRRAIN, which aids in training and employing people with disabilities in the retail sector.



Shri Shashidhar Sinha
(BT/CE/1979)



Dr. Ajay Bhushan Pandey
(BT/EE/1983)

Dr. Ajay Bhushan Pandey is Vice President of Asian Infrastructure Investment Bank. He served as the Chairperson of the National Financial Reporting Authority (NFRA), where he played a pivotal role in upholding the integrity of financial reporting and governance across India. Under his leadership, regulatory frameworks were strengthened and transparency in the financial ecosystem was enhanced, contributing significantly to the development of India's financial infrastructure.

A visionary leader, Dr. Pandey brought deep expertise in finance, technology, and infrastructure, and held several key positions throughout his distinguished career. He was instrumental in shaping government policies, advancing digital identity initiatives, and reforming tax systems. His deep understanding of the intersection between technology and governance helped reshape India's digital and financial landscapes.

As the CEO of the Unique Identification Authority of India (UIDAI), he led the development and implementation of Aadhaar, providing over 1.2 billion Indians with a secure biometric digital identity, which became the foundation of India's Digital Identity revolution. Additionally, his leadership as Chairman of the Goods and Services

Tax Network (GSTN) modernized the tax system, promoting efficiency and transparency for millions of businesses across the country. His work as Finance Secretary further reinforced his influence in shaping India's economic policies during key transformative periods.

Dr. Pandey holds a Ph.D. in Computer Science, adding to his robust academic foundation that complements his practical expertise. His extensive background in the Indian Administrative Service (IAS) has provided him with decades of experience in integrating technology, policy, law, and governance, enabling him to lead some of India's most critical initiatives.

Shri Ranjan Chopra is a Chairman & Managing Director, Team Computers, he is a visionary first-generation entrepreneur who has seamlessly transformed his personal passions into thriving business ventures. As an IIT Kanpur alumnus, his fascination with technology and innovation led him to establish Team Computers in 1988 with a modest start of Rs 54,000. Today, Team Computers has grown into a powerhouse in the tech industry, employing over 5,000 individuals and achieving a turnover of more than Rs 3,500 crore.

Shri Ranjan's love for music and culinary arts further inspired his entry into the hospitality industry, where he has created some of the most celebrated establishments. His ventures include Q'la, a highly-rated restaurant in Delhi with a presence in Goa, and Avataara, a resort that has quickly gained popularity in Goa. Zorba, a stunning banquet venue in Delhi, also stands as a testament to his commitment to delivering exceptional experiences. Shri Ranjan's core belief in "**Vasudhaiva Kutumbakam**" drives his extensive range of social initiatives. His philanthropic efforts include promoting digital literacy and skills development for over 2,000 prisoners in Uttarakhand, advocating for justice that led to the release of more than 90 undertrial prisoners, and educating over 4,500 schoolchildren in digital literacy and cyber safety. His

environmental contributions are equally remarkable, including the planting of over 50,000 native trees, water conservation efforts that harvest 40 lakh liters annually, and measures to prevent forest fires. Shri Ranjan also plays a significant role in animal welfare, revitalizing a veterinary hospital that treats over 5,000 animals and birds each year.

Shri Ranjan completed his engineering in 1983. Throughout his journey, he has been a thought leader in the tech industry, frequently sought after as a speaker and advocate for empowering work cultures. His leadership extends to his social endeavors, where his impact has been felt across communities and environments alike.

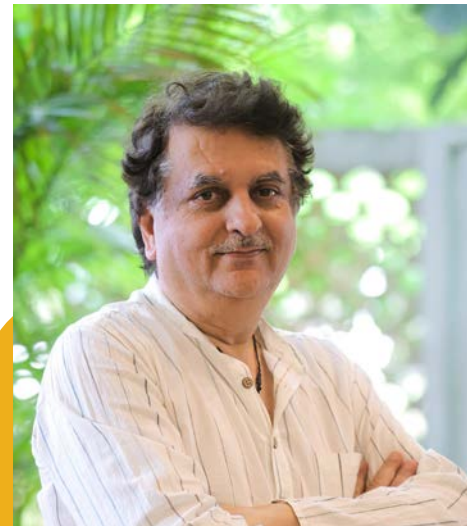

Shri Ranjan Chopra
(BT/EE/1983)



Prof. Sunil K. Agrawal
(BT/ME/1984)

Prof. Sunil K. Agrawal is a globally recognized roboticist and a pioneer in rehabilitation robotics. At Columbia University, he has established a prominent interdisciplinary program that unites faculty from the School of Engineering and Applied Sciences with the College of Physicians and Surgeons. Prof. Agrawal has trained over 40 PhD students, authored more than 500 papers and 4 books, and holds 20 U.S. patents. His work has earned him numerous prestigious accolades, including the ASME Machine Design Award (2016), the ASME Robotics and Mechanisms Award (2016), and the NSF Presidential Faculty Fellow Award from The White House (1994). He has been recognized internationally, receiving the Alexander von Humboldt Foundation U.S. Senior Scientist Award and the Friedrich Wilhelm Bessel Research Award from Germany. He is a fellow of both the American Society of Mechanical Engineers (ASME) and the American Institute for Medical and Biological Engineering (AIMBE). A beloved scholar and mentor, Prof. Sunil Agrawal graduated in the year 1984 from IIT Kanpur. Prof. Agrawal continues to lead transformative research in rehabilitation robotics, showing its potential to improve functions in individuals with neurological injuries such as with stroke, spinal cord injury, cerebral palsy, Parkinson's disease, ALS, and others.

Shri K. Krithivasan, widely known as Krithi, assumed the role of CEO and Managing Director of Tata Consultancy Services (TCS) on June 1, 2023. With over three decades of experience in the technology industry, he has been instrumental in positioning TCS as a global leader in the rapidly evolving digital landscape.

Under his leadership, TCS gained \$2 billion in brand value in 2024, making it the second most valuable IT services brand in the world. His strong focus on customer centricity and employee empathy has been a cornerstone of TCS's culture, leading to the company's recognition as a Global Top Employer 2024 by the Top Employers Institute. TCS, a flagship of India's largest multinational business group, now employs over 603,000 consultants across 55 countries. Shri Krithi also serves on the boards of TCS Iberoamerica, TCS Ireland, TCS Latin America, and the supervisory board of TCS Technology Solutions AG.

Before becoming CEO, he was the Global Head of the Banking, Financial Services, and Insurance (BFSI) Business Group, where he drove strategic growth, enhanced financial performance, and strengthened client relationships. Since joining TCS in 1989, Shri Krithi has held several leadership positions, including heading e-business delivery, where he implemented best practices for managing large-scale programs.

Born in Trichy, Tamil Nadu, Shri Krithi holds a bachelor's degree in Mechanical Engineering from the University of Madras and a master's degree in Industrial and Management Engineering from IIT Kanpur.



Shri K. Krithivasan
(MT/IME/1988)



Prof. Mahan Mj
(MSc5/MTH/1992)

Prof. Mahan Mj, also known as Swami Vidyanathananda, is a distinguished Indian Mathematician and a revered spiritual monk of the Ramakrishna order. His unique journey bridges the realms of science and spirituality, seamlessly combining an austere lifestyle with an unrelenting quest for mathematical discovery.

Prof. Mahan has made significant contributions to hyperbolic geometry, low-dimensional topology, geometric group theory, and complex geometry. His groundbreaking work has been recognized as a major achievement in advancing Thurston's program, which began nearly four decades ago.

His scholarly impact includes the authorship of several papers on Cannon-Thurston maps. In recognition of his pioneering contributions to the field of Mathematical Sciences, he was awarded the prestigious Shanti Swarup Bhatnagar Award in 2011 and the Infosys Prize in 2015. He was an invited speaker at the International Congress of Mathematicians 2018. Currently, he serves as a Professor of Mathematics at the Tata Institute of Fundamental Research (TIFR) in Mumbai. Prof. Mahan's academic journey began when he enrolled at IIT Kanpur in 1987, initially pursuing BT in Electrical Engineering. However, he shifted his focus to his true passion—Mathematics.

He graduated in 1992 with an Integrated MSc degree. He then pursued his PhD at UC Berkeley, completing it in 1997. Following his academic endeavors, he joined the Ramakrishna Mission in 1998, embracing a monastic life that culminated in his ordination as a monk in 2008.

Prof. Senthil Todadri is a Professor at Massachusetts Institute of Technology and a distinguished physicist known for his groundbreaking work in condensed matter theory. His pioneering contributions include the theory of deconfined quantum criticality, which describes a new class of phase transitions, and the discovery of dualities in quantum field theories related to two-dimensional superconducting states. These discoveries have far-reaching implications across many areas in the field of physics. Prof. Todadri's excellence in research has been recognized with prestigious honors, including his election as a Simons Investigator, a Sloan Research Fellow, and a fellow of the American Physical Society. In 2023, he was inducted into the American Academy of Arts and Sciences, and in 2024, he was elected to the National Academy of Sciences, USA. After completing his undergraduate studies at IIT Kanpur and PhD at Yale, he pursued postdoctoral research at the Kavli Institute for Theoretical Physics in Santa Barbara, California. Since 2001, Prof. Todadri has been a professor of physics at MIT, where his research focuses on exploring novel phases and phase transitions of quantum matter that extend beyond conventional paradigms.



Prof. Senthil Todadri
(MSc5/PHY/1992)



Shri Rajat Dhawan
(BT/CHE/1994)

Shri Rajat Dhawan is the Senior Managing Partner of McKinsey & Company India, where he advises CEOs and boards on performance transformation, corporate strategy, and organizational effectiveness, while driving the firm's innovations to deliver holistic client impact.

Over a 27-year career at the firm, he has helped several marquee clients evolve into global leaders across sectors such as automotive, advanced electronics, pharmaceuticals, oil & gas, basic materials, and so forth.

Shri Rajat founded several centers of competence in India that house functional expertise in areas such as AI, analytics, product development, manufacturing, and purchasing.

A Chemical Engineering graduate in the year 1994 and an MBA from IIM Lucknow, he is also a founder and sponsor of Ashoka University: Leading Liberal Arts and Sciences University, in India. Outside of McKinsey, Shri Rajat works to create an enduring impact for communities in India, as a champion of driving sustainable, inclusive, and resilient growth for the Indian economy. He has led the creation of this growth roadmap for "India's Century" through 2047, and specially crafted the funding imperatives for sustainable and inclusive growth in India during its G20/B20 presidency.

Dr. Sumit Gulwani is a Distinguished Scientist and Vice President at Microsoft, where he spearheads scientific advancements in AI technologies and their integration into mass-market products. Dr. Sumit began his professional career at Microsoft Research in 2005. His pioneering work, starting with the famous Flash Fill feature in Excel has significantly shaped the field of AI-assisted programming. It demonstrated that programs can be generated efficiently from imprecise specifications, leading to automation across a wide range of tasks for developers, low-code/no-code users, and even within education to enhance learning experiences for students.

Since 2015, Dr. Sumit has led a blended research and engineering team funded by multiple Microsoft business units, enabling him to deliver popular AI features in numerous Microsoft products. These include the Formula-by-Example feature in Excel, PowerApps, PowerAutomate, Data Connectors in Power Query, by-example cmdlets in PowerShell, IntelliCode Suggestions in Visual Studio, and more recently, various features in multiple Copilots. Dr. Sumit's entrepreneurship exemplifies how deep foundational research can directly influence product development and vice versa.

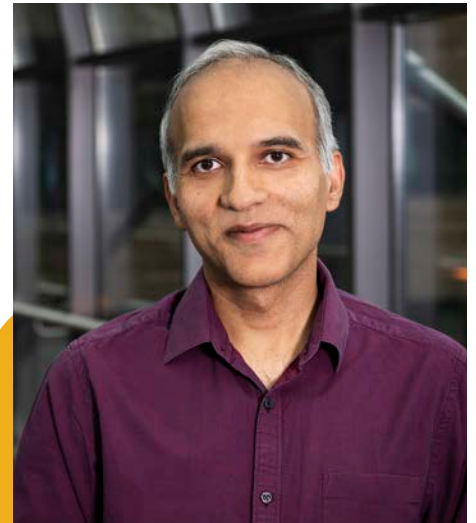

Dr. Sumit Gulwani
(BT/CSE/2000)

Dr. Sumit's pioneering work in neuro-symbolic AI, blending neural methods and symbolic reasoning, has earned him the Max Planck-Humboldt Medal and three Most Influential Paper awards in program synthesis. With 170+ publications and 13 paper awards, he is also a Fellow of ACM and AAIA, and recipient of the ACM SIGPLAN Robin Milner Young Researcher Award. He founded the PROSE Research Fellowship Program in India to support diverse global talent. An ACM Distinguished Speaker, he has delivered over 70 keynotes. Dr. Sumit earned his PhD at UC Berkeley and his undergraduate degree from IIT Kanpur, where he received the President's Gold Medal.



Shri Amit Kumar
(BT/CE/2000)

Shri Amit Kumar is a visionary entrepreneur and co-founder of NoBroker, the world's largest Customer-to-Customer (C2C) marketplace and India's first and only property tech unicorn. In an industry often perceived as opaque with a strong presence of middlemen and information asymmetry, his groundbreaking work with NoBroker has revolutionized the real estate sector by eliminating intermediaries, making property transactions truly between customers.

Over the past decade, NoBroker has grown to a valuation of over ₹8,300 crore and annual revenue of ₹1,200 crore. Under Shri Amit's leadership, it has served over 3 crore customers and saved them ₹16,000 crore in brokerage fees. He has helped employees generate over ₹500 crore through ESOPs and created jobs for 6,500+ people.

Shri Amit, a Civil Engineering graduate and alumnus of IIM Ahmedabad, provides strategic mentorship to entrepreneurs and invests in emerging startups. As a key influencer in the startup ecosystem, his unwavering commitment to advancing entrepreneurship and ecosystem development has established him as a respected leader and a source of inspiration.

Dr. Saurabh Kumar Tiwary serves as the Vice President and General Manager of Cloud AI at Google, where he oversees key product families including Vertex AI, Kaggle, Colab, and AI Studio. A leader in the field of AI, Dr. Saurabh previously served as Corporate Vice President and Technical Fellow at Microsoft, where he played a crucial role in the company's AI transformation. He led the Microsoft Turing group, driving advancements in large-scale model training, inference, and integration across major Microsoft products, including Microsoft Copilot, Office 365, Windows, Edge, and Bing. He also advised the Microsoft Ventures Fund (M12), influencing its AI investments in startups.

At Microsoft, he pioneered several initiatives, including the MS-TAP (Turing Academic Program) and the strategic partnership with OpenAI, integrating GPT-3, ChatGPT, and GPT-4 models into Microsoft products. His leadership roles at both Google and Microsoft position him as a key figure in the AI revolution.

Dr. Saurabh earned his B.Tech from IIT Kanpur in 2001, followed by an MS and PhD from Carnegie Mellon University, and an MBA from the Haas School of Business at UC Berkeley.



Dr. Saurabh Kumar Tiwary
(BT/EE/2001)



Shri Soham Mazumdar
(BT/CSE/2002)

Shri Soham Mazumdar is the CEO and co-founder of WisdomAI, a generative AI-powered data analytics company. His vision for applying AI to solve complex data challenges continues to cement his reputation as a leading innovator in technology.

A serial entrepreneur and technology visionary, Shri Soham previously co-founded Rubrik and served as Chief Architect, helping scale the company to over \$500 million in annual revenue. Under his leadership, Rubrik became a cybersecurity leader with its zero-trust Security Cloud platform and completed a successful IPO in 2024, reaching a \$5.6 billion market capitalization.

His entrepreneurial journey began with Tagtile, where he was Co-Founder and CTO; the company was acquired by Facebook in 2012. Earlier, he served as a technical lead at Google, where he made key contributions to the Teragoogle project and was awarded Google's prestigious Founder's Award by Sergey Brin and Larry Page.

An academic standout, Shri Soham won a Silver Medal at the International Math Olympiad, ranked 3rd in IIT-JEE 1998, earned a Computer Science degree from IIT Kanpur (2002), and completed his Master's at the University of Illinois, Urbana-Champaign (2004).

Shri Soham co-founded WisdomAI, a cutting-edge Gen AI-powered data analytics company, where he currently serves as CEO. His vision for leveraging AI to transform data analytics further solidifies his reputation as an innovator at the forefront of technology.

DISTINGUISHED SERVICES AWARD 2024



Shri Anurag Goel
(BT/ME/1971)

Shri Anurag Goel has 42 years of rich and varied experience spanning industry, academia, and consultancy. Currently, he serves as an independent corporate consultant specialising in innovation and growth and also the Vice Chairman of Pan IIT Alumni India and Chairman of Steering Committee of IIT Kanpur Alumni Convention 2024 where more than 800 IITK alumni participated.

A self-driven professional with entrepreneurial zeal, Shri Goel is dedicated to supporting industry, research, and academia. He advocates for a flexible, innovation-focused mindset and emphasizes Total Quality and Cost Leadership as key to sustained business success and growth.

Shri Goel completed his BT in Mechanical Engineering in 1971. His proactive efforts in addressing IIT Kanpur alumni issues have consistently delivered impactful results. Notably, in March 2013, he organised the IITK Convention at IIT Delhi, attracting nearly 1,350 participants. Almost 40 years ago, he initiated monthly local gatherings for IITK alumni in Ghaziabad, demonstrating his exceptional ability to involve others in alumni activities.

Dr. Rajeev Ranjan is a seasoned engineering leader with over 20 years of experience in the semiconductor and electronic design automation (EDA) industries. Dr. Rajeev Ranjan is currently a CPU Hardware Engineer at Qualcomm, where he is part of the Custom CPU group developing Qualcomm's next-generation Snapdragon Elite processor.

He has worked across startups and established firms, including as Chief Technology Officer at Jasper Design Automation, where he helped pioneer Formal Verification technology and led the company to a successful acquisition by Cadence Design Systems. Throughout his career, he has held key technical leadership roles, built global teams, and fostered strong customer relationships worldwide.

Dr. Ranjan has been serving in the IIT Kanpur Alumni community for close to two decades. As President of the IIT Kanpur Alumni Association Silicon Valley (IITK SVAA) chapter from 2010 to 2012, he cultivated leadership within the community and mentored successive leaders to carry forward the chapter's mission. Dr. Ranjan took over the presidency of the IIT Kanpur Foundation in 2020, and has been instrumental in strengthening the Foundation's image within the North American alumni community. Working with the teams at IIT Kanpur and IIT Kanpur Development Foundation, under Dr. Ranjan's leadership, IITK Foundation has reached new heights in raising funds for the alma mater to enable numerous initiatives that would help IIT Kanpur become one of the world's premier institutions.

Dr. Ranjan earned his B.Tech from IIT Kanpur, in 1990, followed by an MS from the University of Illinois at Urbana-Champaign in 1992. He completed his PhD at the University of California, Berkeley in 1997. He also received an MBA degree from Wharton School of Business, University of Pennsylvania in 2015 and was one of the recipients of the Palmer Scholar award (granted to the top 5% of graduating class).



Dr. Rajeev Ranjan
(BT/EE/1990)

YOUNG ALUMNI AWARD 2024



Prof. Aparna Singh
(BT/MME/2007)

Prof. Aparna Singh is an accomplished researcher and mentor, currently an Associate Professor in the Department of Metallurgical Engineering and Materials Science at IIT Bombay. Her numerous accolades include the Young Metallurgist of the Year (2018) awarded by the Ministry of Steel, the Young Engineer Award (2022) by INAE, and the Young Associateship (2023) by INSA. In 2024, she was elected a member of the National Academy of Sciences.

As a dedicated supervisor, Prof. Aparna has successfully guided eight PhD students to their degrees. Prof. Aparna's academic contributions include more than 70 journal publications along with filing of more than 14 patents, reflecting her innovative approach and commitment to advancing her field. Prof. Aparna's research extends beyond academia, as she actively collaborates with industry leaders to develop advanced materials such as new wheels using advanced steel and epoxy composites for antennas. Her work is characterised by a holistic perspective that integrates the arts, sciences, and engineering, reflecting her belief in the interconnectedness of diverse fields. Her professional career includes a tenure as a Process Integration Engineer in the Technology Development Group in Hillsboro, Oregon, where she received an Organizational Award for developing a pioneering process for creating the next-layer interconnects near the transistor layer.

Prof. Aparna began her academic journey as a B.Tech student at IIT Kanpur, earning top honors including the Director's Gold Medal and the Mars Fontana Prize. She went on to complete her PhD in Materials Science at MIT as an H.F. Taylor Fellow, finishing in four years with a minor in Political Science.

Dr. Abhishek Bhowmick is a visionary technologist and entrepreneur who has made significant contributions to technology, mathematics, and theoretical computer science. As the Co-Founder and CTO of Samootha, he developed a groundbreaking secure data collaboration platform. The startup was acquired by Snowflake, a major public cloud company, for a high-value sum. Samootha's success was recognized by its inclusion in **Fast Company's** Most Innovative Companies list for 2024 and a feature on CNBC.

Before founding Samootha, Dr. Abhishek spent over five years at Apple, leading several privacy and security initiatives at the scale of billions of iPhones worldwide. He forged a path from theoretical research to practical deployment, addressing complex global challenges.

He graduated in Computer Science in 2010 from IIT Kanpur. Beyond his technological achievements, Dr. Abhishek resolved a foundational open problem in information theory that had remained unsolved since 1977, with significant implications for theoretical computer science. His groundbreaking work earned him the rare distinction of being a two-time invited speaker at the Institute for Advanced Study (IAS) in Princeton, hosted by Turing Award winner Avi Wigderson.

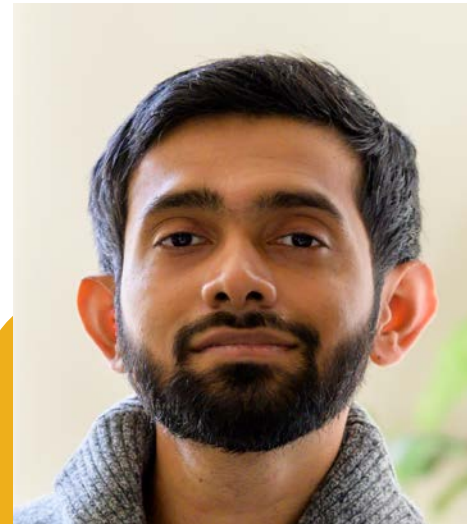

Dr. Abhishek Bhowmick
(BT/CSE/2010)

With a strong commitment to philanthropy and community service, Dr. Abhishek actively collaborates with leading figures in computer science and industry giants to identify opportunities that support and empower exceptional talent. His dedication to advancing fundamental research and mentoring young talent reflects his passion for driving positive change in technology and beyond.



Prof. Pulkit Agrawal
(BT/EE/2011)

Prof. Pulkit Agrawal is an Associate Professor in the Department of Electrical Engineering and Computer Science at MIT, where he directs the Improbable AI Lab. His research focuses on robotics and learning methods for control, making significant advancements in these fields.

Prof. Agrawal's contributions have been widely recognized, including Best Paper at the Conference on Robot Learning (2021) and Best Student Paper at the Conference on Computer Supported Collaborative Learning (2011). He has also received the IEEE Early Career Award in Robotics and Automation, Sony Faculty Research Award, Salesforce Research Award, Amazon Research Award, and a Fulbright Fellowship.

Prof. Agrawal is also an entrepreneur and advisor, co-founding SafelyYou, a company dedicated to reducing falls in people with dementia. He actively advises several other startups, contributing his expertise to drive innovation in the AI space. His work has received substantial recognition, with over 11,000 citations and an h-index of 35, reflecting the significant impact of his research early in his career.

His influence extends beyond academia, with his work featured in renowned platforms like Netflix, BBC, TechCrunch, Forbes, and Wired. Prof. Agrawal is a sought-after speaker, delivering invited talks at major international robotics/AI conferences, and prestigious institutions and companies such as Oxford, UPenn, University of Washington, Toronto, Caltech, Microsoft, Google, IBM and more. Before joining MIT, Prof. Agrawal earned his PhD from UC Berkeley and completed his Bachelor's degree in Electrical Engineering from IIT Kanpur in 2011, where he was awarded the Director's Gold Medal.

AWARDS & RECOGNITION



**Dr. Pravesh K. Kothari
(BT/EE/2010)**

received the Presburger Award from the European Association for Theoretical Computer Science.



**Dr. Ajay Kumar
(BT/EE/1984)**

was appointed Director on the Board of Sify Technologies.



**Mr. Sandeep Kishore Jain
(BT/ME/1988)**

was appointed President of the Federation of Indian Micro Small & Medium Enterprises (FISME).



**Prof. Senthil Todadri
(MSc5/PHY/1992)**

was elected to the National Academy of Sciences, USA.



**Prof. Ashvin Vishwanath
(MSc5/PHY/1996)**

was elected to the National Academy of Sciences, USA.

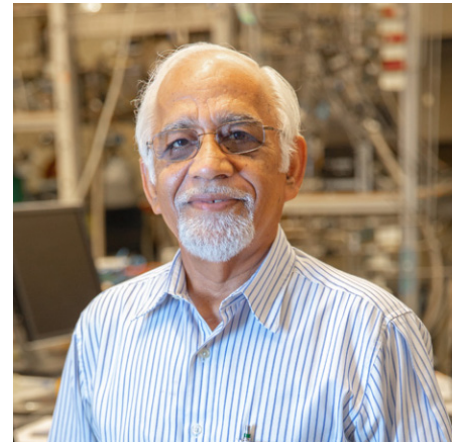

Prof. Raj Singh, (BT/MME/1967)

was elected a Fellow of the American Association for the Advancement of Science (AAAS).

Prof. Raj Singh was honored with the university's prestigious Eminent Faculty Award.



**Dr. Sharat Sinha
(MT/IME/1994)**

was appointed CEO of Airtel Business.



**Mr. Sanjiv Puri
(BT/ME/1985)**

was appointed President of the Confederation of Indian Industry (CII) for 2024–25.



**Mr. Sanjay Malhotra
(BT/CSE/1989)**

was appointed Governor of the Reserve Bank of India (RBI).



**Mr. Rakesh Gangwal
(BT/ME/1975)**

was appointed Chairman of the American carrier Southwest Airlines.



**Dr. Digendranath Swain
(Ph.D/ME/2018)** was awarded the prestigious Rashtriya Vigyan Puraskar 2024 in the category of Space Science and Technology by the Hon'ble President of India, Smt. Droupadi Murmu.



**Prof. Srinivas Bettadpur
(MT/AE/1985)** was recognized with the 2024 Charles A. Whitten Medal.



**Mr. Atul Saxena
(BT/CE/1997)**

was appointed Managing Director & CEO of Stock Holding Corporation of India Ltd.



**Dr. Mohit Kumar Jolly
(BT/MT/BSBE/2010/2012)** received the prestigious Arthur T. Winfree Prize 2024.



**Prof. Rajeev Alur
(BT/CSE/1987)** was awarded the prestigious Knuth Prize 2024.



**Prof. Sandhya S. Visweswariah
(MSc2/CHM/1980)**

became the President-elect of the International Union of Biochemistry and Molecular Biology (IUBMB) at the 26th Ordinary General Assembly.



**Mr. Rahul Navin
(BT/MT/CE/1990/1993)** Senior IRS officer, was appointed Director of the Enforcement Directorate (ED), GOI.



**Dr. Nilesh Pandey
(MT-PhD(Dual)/EE/2023)** was awarded the prestigious IEEE-EDS 2024 Early Career Award.



**Mr. Saikat Guha
(BT/EE/2002)**

was elevated to the prestigious IEEE Fellow.



**Mr. Amit Agrawal
(BT/EE/1991)**

was appointed Secretary of the Department of Pharmaceuticals, Ministry of Chemicals and Fertilizers, Government of India.



**Mr. Vineet Joshi
(BT/ME/1989)**

was appointed secretary of the Department of Higher Education.



**Dr. Priyanka Golia
(Ph.D/CSE/2023)**

received the ACM India Doctoral Dissertation Award for the year 2024.



**Mr. Rupesh Singh
(BT/CE/1991)**

was appointed Director (HR) at Engineers India Limited.



**Dr. Debanjan Chowdhury
(MSc5/PHY/2010)**

was honored with the endowed professorship of Joyce A. Yelencsics Rosevear '65 and Frederick M. Rosevear '64.



**Ms. Abhilasha Tripathi
(Ph.D/CE/2023)**

was honored with the 2024 FAI Award for Outstanding Doctoral Research in Fertilizer Usage.



**Dr. Pawan Goenka
(BT/ME/1975)**

Chairman of Indian National Space Promotion Centre (IN-SPACe), was conferred the prestigious Padma Shri in 2025.



**Shri Gyanesh Kumar
(BT/CE/1985)**

was appointed the 26th Chief Election Commissioner of India.



**Prof. Rajiv K. Varma
(BT/Ph.D/EE/1980/1988)**
was named an IEEE Fellow.



**Mr. Ambarish Kenghe
(MT/CSE/1998)**
was appointed as the Group CEO of
Angel One.



**Mr. Satish Chandra
(BT/CSE/1991)**
was named an ACM Fellow for his
pioneering contributions to software
development tools.



**Prof. Ashish Goel
(BT/CSE/1994)**
was named an ACM Fellow for his
groundbreaking work in algorithms
for social networks, market design,
and civic platforms.

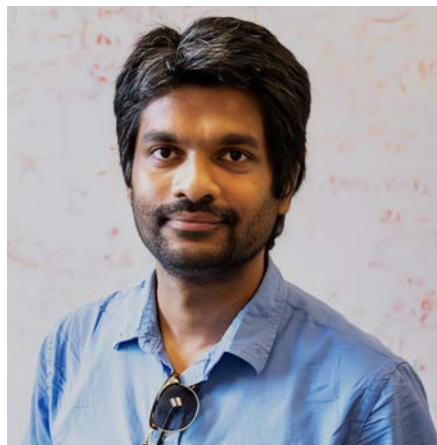

**Dr. Mohit Bansal
(BT/CSE/2008)**
received the prestigious PECASE
Award (Presidential Early Career
Award for Scientists and Engineers)
from the White House.
Dr. Mohit Bansal was named 2025
AAAI Fellow.



**Dr. Jainendra Jain
(MSc2/PHY/1981)**
was awarded the 2025 Wolf Prize in
Physics for his groundbreaking work
on the fractional quantum Hall effect.



**Dr. Achyut Wagle
(Ph.D/ECO/2018)**
was appointed as the Vice
Chancellor of Kathmandu University
(KU) in Nepal.



**Dr. Perna Sinha
(Ph.D/MSP/2023)**
was awarded the Best Thesis Award
in the Carbon Materials category by
the INYAS National Competition for
Research Excellence.



**Late Prof. Pushpak Bhattacharya
(MT/CSE/1986)** was appointed
Chairman of RBI's high-level
committee to develop the Framework
for Responsible and Ethical
Enablement of Artificial Intelligence
(FREE-AI) in the financial sector.



**Prof. Ashutosh Sharma
(BT/CHE/1982)**

was conferred the Padma Shri 2025 for his distinguished service in the field of Nanosciences and Nanotechnology.



**Mr. Aditya Srivastava
(BT-MT(Dual)/EE/2019)**

topped the UPSC 2023 exam with an All India Rank (AIR) 1.

GIVING BACK

Alumni play a crucial role in shaping the institute's journey and future achievements. One significant way they contribute is by giving back to their alma mater. This act of giving reflects their gratitude, enduring bond, and collective dedication to enriching the academic experience for upcoming generations. Owing to their generous support, IIT Kanpur has been able to establish faculty chairs, fellowships for young faculty members, institutional awards, and travel grants.

FACULTY CHAIRS

AIR VICE MARSHAL HARJINDER SINGH VSM CLASS I MBE, CHAIR OF EXCELLENCE

Indian Air Force, Air Headquarters, New Delhi, India Instituted the Air Vice Marshal Harjinder Singh VSM Class I MBE, Chair of Excellence. This Faculty Chair promotes excellence and leadership in teaching, research and development, collaboration, and academic work in the field of developing new and emerging technologies, aerospace technologies in the areas of Aircraft Structural Integrity, Aircraft Health Monitoring, and other allied subjects in the fields of Aeronautics and Aviation.



Prof. Ashoke De from the Department of Aerospace Engineering, IITK, has research interests in multiphase modeling, hybrid RANS/LES model development, supersonic flows and Fluid-Structure interactions (FSI). He is an AvHumboldt Fellow, Fellow of West Bengal Academy of Science and Technology, and currently a member of American Physical Society (APS), American Institute of Aeronautics and Astronautics AIAA (senior), American Society of Mechanical Engineers (ASME), Society of Indian Automobile Manufacturers (SIAM), Fluid Mechanics and Fluid Power (FMFP), Indian Society for Heat and Mass Transfer (ISHMT), and Combustion Institute. He earned his doctorate from Louisiana State University, the USA in 2009.

Current Occupant



Prof. Ashoke De
(April 2022- April 2025)

ARUN KUMAR CHAIR

The family members and friends of Mr. Arun Kumar instituted the Arun Kumar Chair. The Chair is open to all the departments of sciences and engineering, IIT Kanpur.

Late Mr. Arun Kumar (BT/EE/1969) was the President and MD of Flextronics Software Systems. He hailed from the city of Lucknow and did his undergraduate studies from IIT Kanpur in Electrical Engineering. Mr. Kumar went on to complete his Masters in Computer Science from the University of Missouri. Upon his return to India in 1995, Mr. Kumar started working with Hughes Network Systems and soon took the company into horizons of growth and expansion. Mr. Kumar was responsible for expanding HSS business to newer markets and leading it into the business of products. Hughes Network Systems was later acquired by Flextronics Software Systems, a Singapore-based company, where Mr. Kumar served as the President & MD.



Current Occupant



Prof. Aditya K. Jagannatham
(July 2022- July 2025)

Prof. Aditya K. Jagannatham from the Department of Electrical Engineering, IITK, has research interests in next-generation wireless cellular and WiFi networks, with a special emphasis on various 5G technologies and emerging 6G technologies such as OTFS modulation, Terahertz, Visible Light Communication (VLC), Intelligent Reflecting Surface (IRS) Technology, and others. He received his B.Tech degree from the Indian Institute of Technology Bombay, and M.S. and Ph.D. degrees from the University of California, San Diego, USA. He has been awarded the P. K. Kelkar Young Faculty Research Fellowship for excellence in research, multiple Qualcomm Innovation Fellowships (QIF 2018, 2022), the IIT Kanpur Excellence in Teaching Award, and the Upendra Patel achievement award as part of the UMTS modem core group for development of an advanced wireless HSPA+ modem.

ARJUN DEV JONEJA FACULTY CHAIR



Dr. Dev Joneja instituted the Arjun Dev Joneja Faculty Chair for the Department of Civil Engineering, IIT Kanpur. Dr. Dev Joneja (BT/ME/1984) is currently the Chief Risk Officer at Exodus Point Capital Management. Previously, he was the Global Head of Risk and Analytics at Millennium Management LLC and has also served as its Senior Managing Director. Prior to joining the firm in 2009, Dr. Joneja was at Lehman Brothers for 13 years, and served as the Head of Fixed Income Research and as the Global Head of Lehman Indices and Point. He has also served as a Research Analyst at Barclays Capital and as a faculty at the Graduate School of Business at Columbia University in New York.

Prof. Priyanka Ghosh from the Department of Civil Engineering, IIT Kanpur, has research interests in Bearing Capacity of Foundations, Numerical Analysis, Retaining walls and Earth Pressure Theory, Pullout Resistance of Anchors, Stability of Slopes. He has won many awards such as IEI Young Engineers Award 2011-2012 by The Institute of Engineers (India)-2011, Outstanding Young Investigator Award by International Association for Computer Methods and Advances in Geomechanics (IACMAG), USA-2011, Scholarship for Young Indian Researchers by the Italian Ministry of Education, University and Research-2009. He graduated from University of North Bengal and did his PhD from IISc Bangalore in 2005.

Current Occupant



Prof. Priyanka Ghosh
(June 2024- June 2027)

PROF. B. B. LAL CHAIR



The B. B. Lal Chair was instituted by Mr. Vrajesh Lal (BT/MME/1970) in honor of Prof. Braj Bansi Lal, a distinguished archaeologist. This Chair is open to faculty members at IIT Kanpur who have made significant contributions to science and technology in the field of archaeology.

Prof. Braj Bansi Lal, a renowned archaeologist, was the Director General of Archaeology Survey of India from 1968 to 1972. His excavations vary from Palaeolithic times to early historical times. At Kalibangan, Rajasthan, he unearthed a prosperous city of the Indus Civilization. He conducted many excavations in and around the world. In Egypt, he conducted excavations that threw light on Egyptian prehistory. Prof. Lal publications include over 150 seminal research papers, published in scientific journals, both in India and abroad. He authored books *The Earliest Civilization of South Asia* (1997); *India 1947-1997: New Light on the Indus Civilization* (1998). In 1994 Prof. Lal was awarded D. Litt (Honoris causa) by the Institute of Archaeology, St. Petersburg, Russia. He has been the Chairman and member of several committees of UNESCO. In the year 1976, Asiatic Society, Bengal, awarded him S. C. Chakarvarti Medal, & in the year 1979, Nava Nalanda Mahavihara conferred him with the title Mahamahopadhyaya. In recognition of his valuable contribution to archaeology, the President of India honoured him with Padma Bhushan in the year 2000.

Current Occupant



Prof. Javed N. Malik
(June 2024- June 2027)

Prof. Javed N. Malik, from the Department of Earth Sciences, IIT Kanpur, has research interests in Active Fault Mapping, paleoseismology, and paleo-tsunami studies in India. He is a recipient of the National Geoscience Award in Disaster Management; S. Merh Award (2004) in Quaternary Geology, Excellence in Teaching Award (2022), Fellow of Indian National Science Academy (2022).

BIS STANDARDIZATION CHAIR



The Bureau of Indian Standards (BIS) established the BIS Standardization Chair at IIT Kanpur. This initiative aims to institutionalize BIS's engagement with eminent institutes across the country by securing active participation of academia in standards formulation and integrating the teaching of Indian standards into the curriculum. The program has been established to support research and development, teaching, and training in the field of standardization and conformity.

This chair promotes excellence and leadership in teaching, research, and development in the areas of civil, mechanical, chemical, and earthquake engineering, development and management of water resources and renewable energy projects, infrastructure development, and medical biotechnology, nanotechnology, and biomaterials. A seamless integration of technological innovation and standards development is expected to foster the creation of technology-driven products and services.

Prof. M. Jaleel Akhtar from the Department of Electrical Engineering, IIT Kanpur has research interests in RF imaging and non-destructive testing, metamaterial-inspired RF sensors, microwave-biomedical interactions, high frequency plasmonic devices, RF energy harvesting and wireless power transfer, FSS and nanomaterials based wideband microwave absorbers for stealth technology and EMI/EMC applications, RF-material interaction, FSS and metasurface based RF systems.

Prof. Akhtar received his Ph.D. in Electrical Engineering from Otto-von-Guericke University, Germany, in 2003. He is a Fellow of the IEEE, IETE, and the Indian National Academy of Engineering (INAE).

Current Occupant



Prof. M. Jaleel Akhtar
(April 2023- April 2026)

CHAMPA DEVI GANGWAL CHAIR



Mr. Rakesh Gangwal instituted the Champa Devi Gangwal Chair in honor of his mother. Mr. Gangwal (BT/ME/1975), an Indian-American businessman, is the co-founder of IndiGo airlines. He was the Chairman, President, and CEO of Worldspan from 2003-2007. Mr. Gangwal also served as the President and CEO of US Group Airways from 1998-2001. His long association with the airline industry began in 1980, when as an Associate of Booz Allen & Hamilton, Inc, he worked closely with United Airlines. After he joined United Airlines in 1984, he held a series of positions at United Airlines. Previously, Mr. Gangwal had been a financial analyst in the product development group of Ford Motor Company and a production and planning engineer with Philips India Ltd. After graduating from IITK, Mr. Gangwal earned his MBA from Wharton School of the University of Pennsylvania in 1979. Mr. Gangwal is the **Distinguished Alumnus** (2000) of IITK. In 1999, he was recognized by Business Week magazine as one of the 25 top global executives.

Prof. Arun K Saha from the Department of Mechanical Engineering, IIT Kanpur, has research interests in Experimental and Computational Fluid Dynamics & Heat Transfer. His research focuses on the fundamental and applied aspects of jet and wakes, with an emphasis on pollution management and electronic cooling. Prof. Saha earned his PhD from IIT Kanpur in 1999. He received the Best Paper (Heat Transfer Division) award by International Gas Turbine Institute of ASME, New York, 2006.

Current Occupant



Prof. Arun K. Saha
(July 2022 - July 2025)

CHEVRON CORPORATION CHAIR



Mr. Jagjeet Singh Bindra established the Chevron Corporation Chair, which is open to the Department of Chemical Engineering, IIT Kanpur. Mr. Bindra (BT/CHE/1969) is a Director at Edison International, one of the largest electrical utilities based in California. He is also on the board of LyondellBasell Industries NV and HPCL-Mittal Energy Ltd. Mr. Bindra earlier served as the President of Chevron Global Manufacturing (2004–2009). His 32-year career at Chevron began as a research engineer, and he rose through the ranks to lead the company's worldwide manufacturing operations, including 19 refineries.

Mr. Bindra has served on the Boards of Directors of Larsen & Toubro Limited (India), Transfield Services Limited (Australia), and Sriya Innovations Inc. (Kennesaw, Georgia), and currently chairs the Board of Directors at the IIT Kanpur Foundation. After earning his B.Tech degree from IIT Kanpur, Mr. Bindra moved to the U.S. to pursue a Master's in Chemical Engineering from the University of Washington in 1970. He is a Distinguished Alumnus of both IIT Kanpur and the University of Washington College of Engineering.

Current Occupant



Prof. Nishith Verma
(April 2022 - April 2025)

Prof. Nishith Verma from the Department of Chemical Engineering, IIT Kanpur, has research interests in environmental remediation, nanomaterials, catalysts, and sensors. Prof. Verma's research laboratory has played a pioneering role in the country to successfully integrate nanosciences with the development of novel materials as efficient and cost-effective adsorbents and catalysts in combating an array of contaminants in air and water. Prof. Verma is the recipient of the Alexander von Humboldt Research Fellowship (2004) and Fulbright-Nehru Academic and Professional Excellence Fellowship (2018). He earned his Ph.D. from the University of Arizona, Tucson, USA in 1995.

PROF. C.V. SESHADRI CHAIR



Friends, relatives and well-wishers of Late Prof. CV Seshadri set up CV Seshadri Chair under his name in the year 2008. This Chair is open to the Department of Chemical Engineering, IIT Kanpur. Late Prof. C. V. Seshadri was a renowned Indian chemical engineer who began his academic career at IIT Kanpur as an Assistant Professor in 1965 and later became Head of the Chemical Engineering Department and Dean of Student Affairs. He left IITK in 1974 to set up India's first fodder-yeast plant at Kasturi Paper Food and Chemicals Ltd., Bangalore. In 1976, he became the founding Director of the Shri A. M. M. Murugappa Chettiar Research Center in Chennai, where he developed several rural technologies, including Spirulina algae. For this, he received the Jamnalal Bajaj Award in 1981. Prof. Seshadri held a Ph.D. from Carnegie Mellon University and was a Research Associate at MIT. His friends fondly remember him as someone who could mould ordinary people like a potter into good scientists.

Prof. Animangsu Ghatak from the Department of Chemical Engineering, IIT Kanpur, has research interests in Mechanics of soft materials; adhesion, friction and fracture at soft interfaces; Fracture of soft gels; Flow through micro-channels; Protein crystallization; Biomimetic design of engineering materials. He earned his B.Tech from IIT Kharagpur (1994), M.Tech from IIT Kanpur (1998), and Ph.D. from Lehigh University, USA (2003), followed by postdoctoral research at Cambridge and Harvard (2003–2004). He is a SERB-STAR awardee (2020) and a Fellow of the Indian National Academy of Engineering (2018).

Current Occupant



Prof. Animangsu Ghatak
(July 2022 - July 2025)

CLASS OF 1984 CHAIR

The **Class of 1984** instituted **The Class of 1984 Chair**, which is open to all the departments of engineering and sciences, IIT Kanpur.



Current Occupant

Prof. V. Shankar from the Department of Chemical Engineering, IIT Kanpur, has research interests in the field of stability of fluid flows, flow past soft solid surfaces, electrokinetics and electrohydrodynamics, viscoelastic flows. He was elected as an Associate of the Indian Academy of Sciences, Bangalore (2004–2007), and has received several prestigious accolades, including the INSA Medal for Young Scientists (2004), INAE Young Engineer Award (2006), Diamond Jubilee Young Achiever Award from the Indian Institute of Chemical Engineers (2007), and the Arakere Vasudev Young Faculty Research Fellowship at IIT Kanpur (2010–2013). He obtained his undergraduate degree from the Central Electrochemical Research Institute, Karaikudi (1993), and completed his M.E. (1995) and Ph.D. (2000) from the Indian Institute of Science, Bangalore.



Prof. V. Shankar
(June 24 - June 27)

SHRI DEVA RAJ CHAIR



Mr. Deepak Devraj instituted **Shri Deva Raj Chair** in his father's name. This chair is open to all departments of science & engineering at IIT Kanpur. Mr. Devraj (BT/EE/1970) is the managing director of private investment firm Rush Brook Partners in the US. He is also the Founder and Managing Director of the New Jersey-based private investment firm, Raj Associates with investments in real estate and public and private securities. He spent 24 years at Merrill Lynch, leading a team of 700 investment professionals and retiring as Senior Vice President and a member of the executive management committee.

He serves on the Board of Directors of Pratham USA. On his appointment, he said, *“For two decades, Pratham has been singularly focused on improving the quality of education for India’s poor. I believe it represents our single brightest hope for educating India’s children, and I am honored and humbled by the opportunity to help Pratham achieve its mission to have ‘every child in school and learning well.’”*

Mr. Devraj also founded the Raj Center on Indian Economic Policies at Columbia University. He holds a B.Tech. in Electrical Engineering from IIT Kanpur and an MBA from Northeastern University, Boston.

Current Occupant



Prof. Malay Banerjee
(April 2022 - April 2025)

Prof. Malay Banerjee from the Department of Mathematics and Statistics, IIT Kanpur, has research interests in nonlinear dynamics, mathematical ecology, reaction-diffusion equations and spatio-temporal pattern formation, stochastic differential equation models of ecology, delay differential equation models of biological systems, epidemiology. He earned his doctorate from University of Calcutta, Kolkata in 2005.

DR. S. SAMPATH CHAIR



Family and Friends of Dr. Srinivasa Sampath instituted Dr. S. Sampath Chair. This chair is open to the Department of Chemical Engineering at IITK. Late Prof. Srinivasa Sampath (1925–1998) served as a Professor in the Department of Electrical Engineering and as Deputy Director at IIT Madras, where he played a key role in the institute's academic development. He specialized in electron tube design, servomechanisms and controls, electronic measurements, pulse techniques, television engineering, and analogue, digital, and hybrid computer techniques.

In 1981, Prof. Sampath became Director of IIT Kanpur, where he introduced significant advancements in computer science. He established the computer centre based on the DEC 1090 system and set up the UNDP-sponsored Centre for Computer-Aided Design in interdisciplinary areas of Mechanical and Civil Engineering and Fluid Flow Systems.

Prof. Sampath was a pioneer in advancing modern technology in post-independent India, contributing across academia, R&D, industry, and government. He was an outstanding teacher, a role model to his students, and a gifted speaker in education, technology, and spirituality.

Prof. Siddhartha Panda from the Department of Chemical Engineering, IIT Kanpur, has research interests in chemical sensors for healthcare applications and the accompanying transport, reactions, transductions materials processing, and intelligence, utilizing flexible printable platforms. He earned his doctorate from the University of Houston in 1999.

Current Occupant



Prof. Siddhartha Panda
(April 2022- April 2025)

DR. JAG MOHAN GARG CHAIR



Mr. Sudhir M Mittal instituted the Dr. Jag Mohan Chair. This chair is open to all the departments of sciences and engineering at IIT Kanpur. Mr. Mittal (BT/CHE/1970) worked with Union Carbide for 10 years. He switched from job to his own enterprise and set up a special wire manufacturing unit, Sukriti Vidyut Udyog making silver and nickel-plated copper wires that are largely exported to Europe, the USA, and the far east. Mr. Mittal is actively involved in rural and primary education. He is the President of Gram Bharati, near Pilkhuwa, a training school for teachers of village schools. He is presently actively associated with Saraswati Vidya Mandir, Ghaziabad.

Prof. Gautam Sengupta from the Department of Physics, IIT Kanpur, has research interests in the fields of AdS-CFT correspondence & holographic quantum entanglement, conformal field theories, AdS-CFT condensed matter physics. He earned his doctorate from the Institute of Physics, Bhubaneswar in 1992.

Current Occupant



Prof. Gautam Sengupta
(April 2022 - April 2025)

GIREESH JANKINATH CHAIR



Mr. Ravindra Nath Akhoury instituted the **Gireesh Jankinath Chair** in the memory of his late mother. This Chair is open to all the departments of engineering & sciences at IIT Kanpur. Mr. Akhoury (BT/EE/1968) was the Chairman & CEO of MacKay Shields, a multimillion product investment management firm. Known for his investment management business skills, Mr. Akhoury worked with high-ranking multinational corporations such as Fischer, Francis, Trees & Watts, and Equitable Life as Vice-President. After obtaining a B.Tech degree from IITK, Mr. Akhoury obtained an MS in Quantitative Methods from the State University of New York at Stony Brook.

Current Occupant



Prof. Kallol Mondal
(April 2022- April 2025)

Prof. Kallol Mondal from the Department of Material Science and Engineering, IIT Kanpur, has research interest in physical metallurgy, corrosion and oxidation of metals and alloys and thermodynamics of glassy alloys. He has been actively involved in developing improved steels for rails and clips for Indian Railways. He is a recipient of P. K. Kelkar Young Faculty Research Fellowship and Mascot National Award by Electrochemical Society of India. He earned his doctorate in Metallurgical and Materials Engineering from Indian Institute of Technology, Kharagpur in 2005.

GURUMUKH MEHTA CHAIR



Dr. Gurumukh D. Mehta and his wife, Mrs. Veena Mehta instituted Gurumukh D. Mehta & Veena M. Mehta Chair in the Department of Mechanical Engineering, IIT Kanpur. Dr. Gurumukh D. Mehta (MT/ME/1969) is a Senior Scientist and Vice President at Science Applications International Corporation (SAIC), where he has served for over 25 years. SAIC is the largest employee-owned research and engineering company in the United States, providing information technology, systems integration, and e-solutions to both commercial and government clients. Dr. Mehta has supported the U.S. Navy for over two decades in the development, upgrading, testing, and simulation of Tomahawk Cruise Missiles. He is a Fellow of the American Society of Mechanical Engineers (ASME), and has served as International Executive Advisor and past Chairman of the ASME Washington D.C. Section.

He earned his B.E. from Punjab University in 1967, M.Tech. from IIT Kanpur in 1969, and Ph.D. from Brown University in 1974.

Prof. Shantanu Bhattacharya from the Department of Mechanical Engineering, IIT Kanpur, has research interests in Micro-system design and fabrication, bio micro electro mechanical systems, nanotechnology, and lab on chip. Prof. Bhattacharya holds eight patents and has received numerous awards and honors, including the NASI Reliance Platinum Jubilee Award (2019), the Er. M.P. Baya National Award from the Institution of Engineers (India) (2019), elevation to Senior Member of IEEE (2019), and Fellowship of the International Society of Energy, Environment and Sustainability (ISEES) (2018), among others. He earned his Ph.D. from the University of Missouri, Columbia.

Current Occupant



Prof. Shantanu Bhattacharya
(April 2022- April 2025)

HAL CHAIR



Hindustan Aeronautics Ltd. (HAL), Lucknow, instituted the HAL Chair, IIT Kanpur to support a faculty member engaged in advanced research and multidisciplinary work in aircraft systems technology and its applications. Hindustan Aeronautics Ltd., founded in 1980, is an Indian state-owned aerospace and defence company headquartered in Bangalore. Governed by the Indian Ministry of Defence, the company primarily operates in the aerospace industry and is involved in the design, fabrication, and assembly of aircraft, jet engines, helicopters, and their spare parts. Its facilities are spread across India, including locations in Bangalore, Lucknow, Kanpur, Nashik, Hyderabad, Koraput, Korwa, and Kasaragod.

Prof. Arvind Kumar from the Department of Mechanical Engineering, IIT Kanpur, has research interests in solid-liquid phase change (melting/solidification) involving theoretical work, modelling and simulation, and experiments. Dr. Kumar also works in the areas of thermal spray surface coating technologies, and thermal storage and waste heat recovery technologies. Dr. Kumar earned his B.Tech. in Manufacturing Engineering from NIFFT, Ranchi (2001), and his M.Tech. (2003) and Ph.D. (2008) from IISc Bangalore. He later worked in France as a postdoctoral fellow at École des Mines de Nancy and then as a Marie Curie Fellow at the University of Southampton, UK.

Current Occupant



Prof. Arvind Kumar
(June 2024 - June 2027)

INDIAN OIL GOLDEN JUBILEE PROFESSIONAL CHAIR



Indian Oil Ltd. instituted the Indian Oil Golden Jubilee Professional Chair at IIT Kanpur, to be given to a faculty member working in environment friendly technologies in the hydrocarbon sector. Indian Oil Ltd. is an Indian government owned oil and gas company, headquartered in New Delhi, India. It is the largest oil production company in the country. It operates under various divisions such as, refineries, pipelines, marketing, R&D. The company has its subsidiaries in Sri Lanka, Middle East & Mauritius.

Prof. Kamal Krishna Kar from the Department of Mechanical Engineering, IIT Kanpur, has research interests in the areas of materials for supercapacitor, fuel cell, lithium battery, water purification, high performance structural composites, and bioimplants. His research interest areas include carbon nanotubes, graphene, porous carbon, exfoliated graphite, nanostructured advanced materials including nanopolymers, multifunctional and functionally graded composites, nanocomposites including multiscale composites. He holds a PhD degree from IIT Kharagpur (1999).

Current Occupant



Prof. Kamal Krishna Kar
(Nov 2022 - Nov 2025)

INSTITUTE CHAIR PROFESSOR

Institute Chair Professor was instituted by IIT Kanpur to continuously promote academic excellence within the Institute by recognizing the outstanding contributions of senior faculty members, while also attracting distinguished individuals from industry and policymaking to enrich the academic and intellectual ecosystem.



Current Occupant

Prof. V. K. Singh from the Department of Chemistry, IIT Kanpur, has research interests in the synthetic organic chemistry area, specifically asymmetric synthesis. He has been honoured with some of the highest recognitions in science and technology, including the Shanti Swarup Bhatnagar Prize (2004) and the Padma Shri (2014). He is also a Fellow of the Indian National Science Academy and The World Academy of Sciences. He completed his Ph.D. in 1986 from M.S. University, Baroda, India.



Prof. V.K. Singh
(Sep 2024- Sep 2029)

Current Occupant



Prof. Ashutosh Sharma
(January 2022 till the date of
superannuation)

Prof. Ashutosh Sharma from the Department of Chemical Engineering, IIT Kanpur, has research interest in nanofabrication and patterning, colloids & interfaces, functional and nano-materials, self-organized patterns and instabilities in thin films, electrospun materials, wetting, adhesion and friction at soft interfaces, biomaterials & biosurfaces, multiscale MEMS/NEMS & microfluidic systems, carbon micro/nanostructures and composites in environment, health and energy.

He has received several prestigious honours, including the Padma Shri (2025), the Infosys Prize in Engineering and Computer Science (2010), and the Syed Husain Zaheer Medal from the Indian National Science Academy (2011). He is also a Fellow of The World Academy of Sciences (TWAS). He holds a Ph.D. in Engineering from the State University of New York at Buffalo (1987), an M.S. from Penn State University (1984), and a B.Tech from the Indian Institute of Technology Kanpur (1982).

JAL JIVAN MISSION PROFESSOR CHAIR



जल शक्ति मंत्रालय MINISTRY OF JAL SHAKTI

The Jal Jivan Mission Professor Chair is established with the support of the Ministry of Jal Shakti, Department of Drinking Water and Sanitation. The establishment of this Faculty Chair is expected to carry out high quality empirical and applied research in rural drinking water and sanitation sector to address sectoral challenges and facilitate the achievement of 'Har Ghar, Jal' and 'ODF Plus' in rural India.

Jal Jeevan Mission (JJM), launched by the Hon'ble Prime Minister of India on 15th August, 2019 from the ramparts of the Red Fort, aims to enable every rural household to have Functional Household Tap Connection (FHTC) by 2024. It is envisaged that with FHTC, each household will have potable water supply in adequate quantity (at least 55 lpcd) of prescribed quality (as per BIS 10500:2012) on a regular and long-term basis. National Jal Jeevan Mission (NJJM), Department of Drinking Water and Sanitation, Government of India is responsible for, inter alia, implementation of JJM across the country, provide policy guidance, and build partnerships with State Governments to achieve the goals of JJM which is currently under implementation. Alongside, the Government of India has approved Phase II of Swachh Bharat Mission (Grameen) in February 2020 to sustain the Open Defecation Free (ODF) status of villages and to improve the levels of cleanliness in rural areas through solid and liquid waste management activities, making villages ODF Plus.

Prof. Amit Mitra from the Department of Mathematics and Statistics, IIT Kanpur, has research interests in statistical signal processing, data mining of financial and economic time series, and parameter estimation of non-linear time series models. Before joining IIT Kanpur in a full-time academic capacity, Prof. Mitra served in key roles at the Reserve Bank of India, where he worked in the Department of Statistical Analysis and Computer Services as Research Officer and later Assistant Advisor. He has also taught at IIT Bombay and held international research appointments, including a post-doctoral position at Uppsala University, Sweden.

Prof. Mitra has earned several accolades such as the Distinguished Teacher Award at IIT Kanpur (2010), the M. N. Murthy Award by ISI for applied statistical research, and national-level fellowships. He earned his M.Sc. and Ph.D in Statistics from IIT Kanpur, completing his doctoral research in 1996 under the supervision of Prof. Debasis Kundu.

Current Occupant



Prof. Amit Mitra
(July 2022 - July 2027)

JOY GILL CHAIR



Mr. Ajit S. Gill instituted the Joy Gill Chair. This chair is open to the faculty, working in the area of Biological Sciences and Bioengineering. Mr. Ajit S. Gill (BT/EE/1969) is the President and CEO of Greenfire Bio LLC and MGF Corporation based in Frisco, Texas, USA. He also serves on the Board of Directors of Pacylex Pharmaceuticals, Inc. Previously, he was the CEO of Ohm Oncology, California, a company focused on developing novel drugs for the treatment of refractory and hard-to-treat cancers. Mr. Gill has also held leadership roles as President and CEO of Nektar Therapeutics and as Vice President and General Manager of Kodak's Interactive Systems Division. After graduating from IIT Kanpur, he earned his M.S. from the University of Nebraska and an MBA from the University of Western Ontario, Canada.

Prof. Bushra Ateeq from the Department of Biological Sciences and Bioengineering, IIT Kanpur, has research interests in exploration of the genetic and epigenetic changes that initiate cancer progression, and understanding the molecular events that drive resistance to chemotherapeutic drugs.

Prof. Ateeq, a recipient of the Shanti Swarup Bhatnagar Prize in Medical Sciences (2020), has been recognized with several prestigious awards, including the Sun Pharma Science Foundation Research Award (2021), N. Ramachandran-National Bioscience Award (2020), and ICMR-Basanti Devi Amir Chand Prize (2019). She is an elected Fellow of NASI and IASc, and earned her Ph.D. from Aligarh Muslim University in 2003.

Current Occupant



Prof. Bushra Ateeq
(April 2022 - April 2025)

KENT ENTREPRENEURSHIP & INNOVATION CHAIR



Mr. Mahesh Gupta instituted the KENT Entrepreneurship & Innovation Chair. This chair is open to faculty working on new technologies & innovations. Mr. Mahesh Gupta (BT/ME/1975), a well-known name in the water purification industry, is the Founder & Chairman of KENT RO Ltd., India. He is the man behind revolutionizing purified drinking water in India. He patented the technology in 1990 and launched the brand Kent RO. After founding his company in late 90s, Mr. Gupta diversified into other products like, vacuum cleaner, water softener, air purifiers and many others. Before starting his own business venture, Mr. Gupta joined Indian Oil Corporation and worked as an engineer on conservation of fuel. He holds more than half a dozen patented technologies.

Prof. Amitabha Bandhopadyay from the Department of Biological Sciences & Bioengineering, IIT Kanpur, has research interests in mechanisms of cartilage and bone differentiation. He earned his doctorate from Albert Einstein College of Medicine, Yeshiva University, New York in 2002. He also served as the Secretary and Treasurer of the Indian Society of Developmental Biologists (InSDB).

Current Occupant



Prof. Amitabha Bandhopadyay
(July 2022 - July 2025)

LALIT MOHAN KAPOOR CHAIR



Mr. Lalit Mohan Kapoor established the Lalit Mohan Kapoor Chair. This chair is open to any outstanding faculty member across all departments at IIT Kanpur. Mr. Lalit Mohan Kapoor (BT/CHE/1971) is the Founder, President, and CEO of Group BiGates Inc. USA, established in 2000. BiGates is an IT outsourcing company that provides business solutions to enterprises across the United States, with a primary focus on ERP solutions.

Current Occupant

Prof. Sankar Prasad Rath from the Department of Chemistry, IIT Kanpur, has research interests in the fields of physical-inorganic and bioinorganic chemistry with special emphasis on the structure-function correlation utilizing a wide variety of synthetic and spectroscopic methods combined with DFT calculations. His current research interests are bioinorganic modelling of multi-heme proteins/enzymes, chemical biology, medicinal inorganic chemistry, supramolecular chirogenesis and development of NMR spectroscopy for paramagnetic molecules. He has received several prestigious awards, including the P.K. Kelkar Fellowship, Alexander von Humboldt Fellowship, CRSI Bronze Medal, C.N.R. Rao National Prize, JSPS Fellowship, and the SERB-STAR Award. He earned his Ph.D. in Chemistry from IACS, Kolkata in 1999.



Prof. Sankar Prasad Rath
(April 2022 - April 2025)

MINISTRY OF SKILL DEVELOPMENT AND ENTREPRENEURSHIP (MOSDE) CHAIR

Mr. R. P. Dhingra instituted the Ministry of Skill Development & Entrepreneurship Chair. This chair is open to all the departments of engineering and sciences at IIT Kanpur. The Ministry is responsible for coordination of all skill development efforts across the country, bridging the gap between demand and supply of skilled manpower, building the vocational and technical training framework, skill up-gradation, building of new skills, and innovative thinking not only for existing jobs but also jobs that are to be created.



Current Occupant

Prof. Saikat Chakrabarti from the Department of Electrical Engineering, IIT Kanpur, has research interests in electric power systems, state estimation of transmission and distribution systems, stability and control of power systems with high penetration of renewable energy, operation and control of microgrids, modeling of generators and loads, and planning and operation of distribution systems.



Prof. Saikat Chakrabarti
(July 2022 - July 2025)

MR. & MRS. GIAN SINGH BINDRA CHAIR



Mr. Jagjeet Singh Bindra instituted the **Mr. & Mrs. Gian Singh Bindra Chair** at IIT Kanpur, dedicated to the Department of Chemical Engineering.

Mr. Jagjeet Singh Bindra (BT/CHE/1969) serves as a Director at Edison International, one of the largest electric utility companies based in California. He previously held the position of President, Chevron Global Manufacturing (2004–2009), capping a distinguished 32-year career at Chevron that began as a research engineer and culminated in leading the company's global manufacturing operations, including 19 refineries. Mr. Bindra has served on the Boards of Larsen & Toubro Limited (India), Transfield Services Limited (Australia), and Sriya Innovations Inc. (USA). He currently chairs the Board of Directors of the IIT Kanpur Foundation. He holds a B.Tech. degree from IIT Kanpur and a Master's in Chemical Engineering from the University of Washington (1970). Mr. Bindra is a Distinguished Alumnus of both institutions.

Prof. Yogesh M. Joshi from the Department of Chemical Engineering, IIT Kanpur, has research interests in rheology, colloidal glasses, and gels. He has received numerous prestigious awards, including the Shanti Swarup Bhatnagar Prize in Engineering Sciences (2015), J.C. Bose Fellowship (2023), DRDO Academy Excellence Award 2019, DAE-SRC Outstanding Investigator Award (2012), and the RPG Life Sciences M. M. Sharma Gold Medal (2017). He is also a recipient of the INSA Medal for Young Scientist (2006), INAE Young Engineer Award (2008), and the NASI-Scopus Young Scientist Award.

Prof. Joshi is also an elected Fellow of the Indian National Science Academy (INSA), Indian Academy of Sciences (IAS), and the Society of Rheology, USA. He earned his undergraduate degree from Pune University in 1996 and completed his Ph.D. from IIT Bombay in 2001.

Current Occupant



Prof. Yogesh M. Joshi
(June 2024 - June 2027)

N. RAMA RAO CHAIR



The Chair was established in the Department of Computer Science and Engineering with a generous donation from Mr. Narayana Murthy in memory of his father, Mr. N. Rama Rao.

Mr. Nagavara Ramarao Narayana Murthy (MT/EE/1969) is one of the most distinguished alumni of IIT Kanpur. He is the Co-founder of Infosys and served as its Chairman before retiring as Chairman Emeritus in 2011.

Mr. Murthy began his career as Chief Systems Programmer at IIM Ahmedabad and later worked with Patni Computer Systems, Pune. In 1981, he founded Infosys, which went on to become a global leader in IT services. He has been recognized by Fortune magazine as one of the 12 greatest entrepreneurs of our time, and Time magazine referred to him as the “father of the Indian IT sector” for his pioneering role in establishing India as a hub for outsourcing. He has been honored with the Padma Vibhushan and Padma Shri by the Government of India.

Prof. Nitin Saxena from the Department of Computer Science and Engineering, IIT Kanpur, has research interests in the fields of algebraic structures and the related computational problems. He conceptualized “rank-concentration in circuits” and “algebraic dependence” in several high-profile papers, he also introduced “bootstrapping of variables” an unexpected phenomenon that identifies a plethora of simple polynomials such that understanding any one of them would mean understanding general circuits. This further led to identifying SOS (Sum-of-Squares) as the key model to study. He solved classical problems in root-finding, factoring and primality.

Prof. Saxena earlier served as a Scientific Researcher in CWI, Amsterdam (2006-08) and a faculty in Hausdorff Center for Mathematics, Bonn (2008-13). He is the recipient of many prestigious

awards and honors, such as Shanti Swarup Bhatnagar Prize (2018), Young Faculty Research Fellowship (2018-21), DST SwarnaJayanti Fellowship Award (2013-14) in Mathematics (project duration 2015-20), Indian National Science Academy Young Scientist Medal in Mathematical Sciences (2015), Godel Prize (2006),Fulkerson Prize (2006), Distinguished Alumnus Award (2003), Global Indus Technovators Award (2003).

Current Occupant



Prof. Nitin Saxena
(May 2024 - April 2029)

NEXT GENERATION BROADCASTING FACULTY CHAIR



ONE Media Broadcast Group, Inc. instituted The Next Generation Broadcasting Chair. This chair is open to faculty from the departments of engineering at IIT Kanpur.

ONE Media 3.0, headquartered in Hunt Valley, Maryland, USA, is a subsidiary of Sinclair Broadcast Group, Inc. It aims to build and globally deploy the Next Generation Broadcast Platform, enabling broadcasters to be competitive across all platforms in delivering enhanced video and data services.

Prof. Adrish Banerjee from the Department of Electrical Engineering, IIT Kanpur, has research interests in the physical layer aspects of communications, particularly theory and applications of error control coding, molecular communications, and broadcasting. Prof. Banerjee has been actively involved in projects related to 5G. He is the recipient of prestigious awards and honors such as IETE-Prof. K. Sreenivasan Memorial Award (2016), P. K. Kelkar Research Fellowship, IIT Kanpur (2013-16), Institute of Engineers India Young Engineer Award, Microsoft Research India Outstanding Young Faculty Award (2009). Banerjee earned his doctorate from the University of Notre Dame, USA in 2003.

Current Occupant



Prof. Adrish Banerjee
(July 2022 - July 2025)

OM PRAKASH GAUTAM FACULTY CHAIR



Dr. Rajeev Gautam instituted the Om Prakash Gautam Faculty Chair to reward a distinguished professor in the Chemical Engineering department at IITK.

Dr. Rajeev Gautam (BT/CHE/1974) was President & CEO of Honeywell Performance Materials and Technologies (PMT) until his retirement in late 2021 after 43 years with the company. Honeywell PMT is a global leader in providing advanced materials, process technologies and automation solutions, with sales of \$10 billion in 2021. Rajeev also served as President of Honeywell UOP, one of the leading suppliers of process technologies that have formed the foundation for most of the world's refiners, efficiently producing gasoline, diesel, jet fuel, petrochemicals and renewable fuels. He also served as Vice President and Chief Technology Officer of PMT. Prior to that he held key positions within UOP, spanning research and development, engineering, and marketing, including Vice President and Chief Technology Officer of UOP. Dr. Rajeev began

his career with Union Carbide in 1978 and became part of UOP through a joint venture in 1988. Throughout his career, he has championed innovative solutions for industry needs and has been responsible for the development and commercialization of a broad range of catalytic and separations applications for the refining, petrochemical and gas processing industries. Dr. Gautam holds his PhD degree in Chemical Engineering from the University of Pennsylvania and MBA from the University of Chicago.

Current Occupant

Prof. Jayant K. Singh from the Department of Chemical Engineering, IIT Kanpur, has research interests in material modeling and simulation, adsorption and separation, force-field generation, thermodynamics, molecular simulation. Prof. Singh is the founder of Prescience In Silico, focused on accelerating drug and material discovery, and the inventor of Bhu-Parikshak (a handheld soil sensor) and Munh-Parikshak (an oral cancer detection tool). His accolades include the INAE-SERB Abdul Kalam Fellowship, NASI-Reliance Platinum Award, SERB STAR Award, and Alexander von Humboldt Fellowship. Prof. Singh earned his B.Tech. in Chemical Engineering from IIT Kanpur in 1997, followed by an M.S. in Computer Science (2002) and a Ph.D. in Chemical Engineering (2004) from SUNY Buffalo, USA.



Prof. Jayant K. Singh
(Jan 25 - Jan 2028)

PANDIT GIRISH RANJAN & SUSHMA RANI PATHAK CHAIR



Mr. Kamalesh Dwivedi instituted the Pandit Girish Ranjan & Sushma Rani Pathak Chair.

Mr. Kamalesh Dwivedi (BT/EE/1979) is the President and General Partner at 3 Lines Venture Capital based out of Denver, USA. His current investment interests span over a broad spectrum of technology in early stage Startup companies in USA and India. Mr. Dwivedi has been CIO of several major corporations such as Computer Vision, Scientific Atlanta, ADC Telecommunications, TeleTech Holdings in the US and BellSystem24 in Japan in their transformative phases. As a CIO, he has been a member of C-Level teams which enabled multi-billion dollar return in portfolio companies of global Private Equity firms.

Mr. Dwivedi holds a Bachelor of Technology degree from IIT Kanpur, an M.Eng. from Carleton University and has completed the Program for Management Development (PMD) from Harvard Business School.

Current Occupant

Prof. Anish Upadhyaya from the Department of Material Sciences & Engineering, IIT Kanpur, has research interests in powder metallurgical processing of materials with emphasis on sintering. He is the recipient of many awards and fellowships such as Metallurgist of the Year Award (2009), P.K. Kelkar Research Fellow (2009-2012), INSA Young Scientist of the Year (2004), Young Metallurgist of the Year (2003) and INAE Young Engineer Award (2002). He completed B.Tech from IIT BHU in 1994, and MS and PhD from Penn State University.



Prof. Anish Upadhyaya
(June 2024 - June 2027)

PANDIT RAMCHANDRA DWIVEDI CHAIR



Mr. Kamalesh Dwivedi (BT/EE/1979) instituted the Pandit Ramchandra Dwivedi Chair. This chair is open to all departments of engineering and sciences at IIT Kanpur. Mr. Dwivedi is the President and General Partner at 3 Lines Venture Capital, based in Denver, USA. His current investment interests span a broad spectrum of technologies in early-stage startups in both the USA and India. Mr. Dwivedi has served as CIO for several major corporations, including Computer Vision, Scientific Atlanta, ADC Telecommunications, TeleTech Holdings (USA), and BellSystem24 (Japan), during their transformative phases. As CIO, he was part of C-level teams that enabled multi-billion-dollar returns in portfolio companies of global private equity firms. Driving growth, leading turnarounds in large corporations, and mentoring employees have been among his most fulfilling professional experiences. He holds a B.Tech. from IIT Kanpur, an M. Eng. from Carleton University, and has completed the Program for Management Development (PMD) at Harvard Business School.

Prof. Abhijit Kushari from the Department of Aerospace Engineering, IIT Kanpur, has research interests in aerospace propulsion, gas turbine engines, turbo-machinery, liquid atomization, fire dynamics, flow control and combustion dynamics. He has established a state-of-the-art laboratory for research on fire dynamics and aerospace propulsion at IIT Kanpur through active collaborations and partnerships with ADA, ADE, GTRE, CFEES, TBRL, ARDE, BARC, ISRO, Pratt and Whitney, GE Aviation, HAL, Airbus, HPCL, AR&DB, etc. He serves as member of various project review committees for multiple development programs of DRDO. He earned his doctorate from Georgia Institute of Technology in 2000.

Current Occupant



Prof. Abhijit Kushari
(April 2022 - April 2025)

PRADEEP SINDHU CHAIR



Mr. Pradeep Sindhu (BT/EE/1974) established the Pradeep Sindhu Foundation, which supports the Pradeep Sindhu Chair. The Chair has been instituted for the path-breaking research in the field of Mathematics & Statistics. Mr. Sindhu is the CEO & Founder of data center technology company, Fungible. Known for his entrepreneurial skills, Mr. Sindhu is a renowned name in technology development & innovation. He founded Juniper Networks in 1996 in California where he served as the Chief Scientist and CTO for over 20 years. He played an instrumental role in the architecture, design and development of the M40 router.

Current Occupant

Prof. Dattatraya H. Dethe from the Department of Chemistry, IIT Kanpur, research interests in biomimetic total synthesis of natural products, development of enantioselective metal catalysed new C-C and C-X bond forming reactions. Prof. Dethe and his group have made significant contributions to the asymmetric total synthesis of biologically active natural products and the development of novel techniques for synthesizing optically active compounds relevant to medicinal chemistry. He is a Fellow of the National Academy of Sciences (FNASc) and recipient of several prestigious awards, including the CSIR Young Scientist Award (2011), OPPI Young Scientist Award (2011), AVRA Young Scientist Award (2014), CRSI Bronze Medal (2020), and the SERB-STAR Award (2020). He earned his Ph.D. in synthetic organic chemistry from IISc Bangalore in 2005.



Prof. Dattatraya H. Dethe
(April 2022 - April 2025)

P. K. KELKAR CHAIR



Dr. Purushottam Kashinath Kelkar (1909–1990) is best remembered as the founding Director of IIT Kanpur, established in 1959. Born in Karnataka, he graduated in Physics from the Royal Institute of Science, Mumbai (1931), earned a Diploma in Electrical Engineering from IISc Bangalore (1934), and completed his Ph.D. from the University of Liverpool under Dr. J. C. Prescott. His association with IITs began in 1956 as Planning Officer at IIT Bombay, later becoming its Deputy Director. In December 1959, he became the first Director of IIT Kanpur, where he introduced a visionary curriculum integrating engineering, science, humanities, and social sciences, and emphasized faculty-led research. He played a key role in launching the Kanpur Indo-American Program (KIAP) with a consortium of nine U.S. universities. In 1970, he was appointed Director of IIT Bombay, contributing significantly to its growth. For his contributions to technical education, he was awarded the Padma Bhushan in 1969.

Prof. Amit Kumar Agarwal from the Department of Physics, IIT Kanpur, has research interests in the areas of topological materials, collective excitations, and nanoscale device modeling, focusing on electronic structure, surface states (ARPES), magneto-transport, plasmons (EELS), charge density waves, and ferroelectric devices. He has received several honors, including the N. S. Satya Murthy Memorial Award, NASI Young Scientist Award (2013), P. K. Kelkar Research Fellowship, and was a Junior Associate at ICTP and Adjunct Faculty at HRI (2015–2016). He completed his M.S. and Ph.D. from IISc Bangalore.

Current Occupant



Prof. Amit Kumar Agarwal
(June 2024 - June 2027)

PAVITAR JONEJA CHAIR



Dr. Joneja instituted the Pavitar Joneja Chair in the Humanities and Social Science Department at IIT Kanpur in honor of his mother, Smt. Pavitar Joneja. This Chair promotes excellence in research and leadership in the broad disciplines including; English, Fine Arts, Philosophy, Psychology & Sociology. Dr. Dev Joneja (BT/ME/1984) is currently the Chief Risk Officer at Exodus Point Capital Management. Previously, he was the Global Head of Risk and Analytics at Millennium Management LLC and has also served as its Senior Managing Director. Prior to joining the firm in 2009, Dr. Joneja was at Lehman Brothers for 13 years, and served as the Head of Fixed Income Research and as the Global Head of Lehman Indices and Point. He has also served as a Research Analyst at Barclays Capital and as a faculty at the Graduate School of Business at Columbia University in New York.

Prof. Braj Bhushan from the Department of Humanities and Social Sciences, IIT Kanpur, has research interests in cognitive neuropsychology, cognitive ergonomics, trauma psychology. His major areas of work are affective processes and assessment, within which he has extensively worked on development and validation of various databases, further examining its application using behavioural as well as neuropsychological methods. He is Fellow of the Association for Psychological Science, USA and a Chartered Psychologist of the British Psychological Society. He earned his doctorate from Babasaheb Bhimrao Ambedkar Bihar University, India in 2003.

Current Occupant



Prof. Braj Bhushan
(April 2022 - April 2025)

POONAM AND PRABHU GOEL CHAIR



Dr. Prabhakar Goel (BT/EE/1970) instituted the Poonam and Prabhu Goel Chair in the Department of Computer Science and Engineering at IIT Kanpur. Dr. Goel is an Indian-American researcher and an entrepreneur. After completing his B.Tech from the Department of Electrical Engineering, IIT Kanpur in 1970, he went on to pursue PhD from Carnegie Mellon University, USA. Post his doctorate, Dr. Goel joined IBM's EDA organization where he developed PODEM Automatic test pattern generation & Verilog hardware description language, one of his most famous works.

Prof. Pratik Sen from the Department of Chemistry, IIT Kanpur, has research interests in ultrafast laser spectroscopy, single-molecule spectroscopy, and fluorescence spectroscopy. He has received several honors, including the INSA Young Scientist Medal (2012), CRSI Bronze Medal (2021), and Fellowship of the Royal Society of Chemistry (2021). He is also a former INYAS member (2016–2020) and recipient of Young Faculty Fellowships from IIT Kanpur and the Ministry of Electronics & IT. He earned his Ph.D. from IACS, Kolkata, in 2006.

Current Occupant



Prof. Pratik Sen
(April 2022 - April 2025)

Current Occupant



Prof. Amey Karkare
(July 2022 - July 2025)

Prof. Amey Karkare from the Department of Computer Science and Engineering, IIT Kanpur, has research interests in intelligent tutoring systems, program analysis, compiler optimization, and functional programming. He did his B.Tech. from IIT Kanpur in 1998 and Ph.D. from IIT Bombay in 2009. Dr. Karkare received the prestigious Infosys fellowship during his Ph.D. and P. K. Kelkar Young Research Fellowship at IIT Kanpur. He has been a visiting researcher at Microsoft Research, Redmond, and IIT Bombay.

Prof. Ashok Kumar from the Department of Biological Sciences & Bioengineering, IIT Kanpur, has research interests in developing smart polymeric biomaterials and supermacroporous matrices for applications in biology and biotechnology. His recognitions include the TATA Innovation Fellowship (2013), Madhav Rao Scindia Memorial Award (2013), Samsung-GRO Research Award (2012), and FAOB Executive Board Membership (2008). He is a Fellow of INAE and NAMS (2024). He earned his Ph.D. jointly from IIT Roorkee and IGIB, Delhi, and conducted postdoctoral research in Sweden and Japan. Before joining IIT Kanpur in 2004, he was a faculty member at Lund University, Sweden.

Current Occupant



Prof. Ashok Kumar
(June 2024 - June 2027)

PROF. N. C. NIGAM CHAIR



Late Prof. N. C. Nigam's family & friends instituted the N. C. Nigam Chair in his memory. The Chair is open to all the departments of science and engineering, IIT Kanpur. He served as a faculty member and Head of the Department of Aerospace Engineering at IIT Kanpur, and is a Distinguished Alumnus of IIT Roorkee.

Current Occupant

Prof. Manas K. Ghorai from the Department of Chemistry, IIT Kanpur, has research interests in synthetic organic chemistry. His research focuses on aziridine and azetidine chemistry, dianion chemistry, memory of chirality, and organocatalysis. He earned his doctorate from the National Chemical Laboratory, Pune in 1998.



Prof. Manas K. Ghorai
(July 2022 - July 2025)

PROF. R. N. BISWAS FACULTY CHAIR IN TEACHING EXCELLENCE



The Prof. R. N. Biswas Faculty Chair in Teaching Excellence has been established by IITK alumni to recognize faculty members who demonstrate exceptional commitment to undergraduate teaching and to encourage innovation in pedagogy. Prof. R. N. Biswas was born in 1939 and obtained his BSc degree with Physics Honours in 1957 from Presidency College, University of Calcutta. He pursued MSc.(Tech) from Institute of Radio Physics and Electronics, University of Calcutta in 1960. He completed his PhD in 1966 from University of California at Berkeley in Electronic Circuits. He joined IIT Kanpur in 1967 as an Assistant Professor and he is one of the most respected, honoured, and idolized professors of the Institute.

Current Occupant

Prof. Baquer Mazhari from the Department of Electrical Engineering, IIT Kanpur, has research interests in microelectronics, focusing on semiconductor devices, and analog/digital circuits. His research over the past two decades has emphasized organic and flexible electronics, contributing to the establishment of the Samtel Centre for Display Technologies (2000) and the National Centre for Flexible Electronics (2014) at IIT Kanpur. He is a recipient of the Distinguished Teacher Award, Gopal Das Bhandari Memorial Award, and Excellence in Teaching Award from IIT Kanpur. He earned his Ph.D. from the University of Illinois at Urbana-Champaign in 1993.



Prof. Baquer Mazhari
(Feb 2022 - Feb 2025)

PROF. T R VISWANATHAN CHAIR IN TEACHING EXCELLENCE



Instituted through generous contributions from the IITK alumni, Prof T R Viswanathan Chair in Teaching Excellence honors Prof. T.R. Viswanathan, a founding faculty member of IIT Kanpur. This Chair honors faculty who have demonstrated excellence in undergraduate teaching and encourages innovation in pedagogy, recognizing those who have made a lasting impact through their dedication to teaching and mentorship.

He served as Professor of Electrical Engineering, Head of the Computer Centre, and Dean of R&D, and was known for his work in Analog Integrated Circuit Design and mentoring graduate students in Electrical and Computer Engineering.

Dr. T. R. Viswanathan spent 15 years in industry, contributing to R&D, product design, and management, and retired as Director of R&D at Texas Instruments. He later served as a Partner at Artiman Ventures. He earned a B.Sc. in Physics from the University of Madras (1956),

receiving the Jagirdar of Arni Gold Medal, and completed his degree in Electrical & Communications Engineering from IISc Bangalore (1959). He went on to earn an M.Sc. (1961) and Ph.D. (1964) in Electrical Engineering from the University of Saskatchewan, Canada. Dr. Viswanathan was a Research Professor Emeritus at the University of Texas at Austin, where he held the Silicon Laboratories Endowed Chair for thirteen years.

Prof. Alope Kumar Dutta from the Department of Electrical Engineering, IIT Kanpur, has research interests include semiconductor device modeling, with tertiary interest in Analog/RF circuits and semiconductor fabrication technology. He earned his B.E. in Electrical Engineering from Jadavpur University, receiving five medals including the prestigious Dr. B.C. Roy Gold Medal for topping all engineering streams. After a brief tenure at Engineers India Ltd., he pursued his M.Tech. and Ph.D. in Electrical Engineering from Louisiana State University, USA.

Current Occupant



Prof. Alope Kumar Dutta
(April 2023 - April 2026)

RAHUL & NAMITA GAUTAM CHAIR



Mr. Rahul Gautam, along with his wife, Mrs. Namita Gautam, instituted the Rahul & Namita Gautam Chair. Mr. Rahul Gautam (BT/CHE/1975) is the Director of Sheela Foam and Chairman of Joyce Pvt. Ltd. In 1971, he along with his mother, founded one of India's largest foam manufacturing companies, Sheela Foam, branded as Sleepwell mattresses. Under the leadership of Mr. Gautam, his company expanded wings offshores as well setting up manufacturing units in Australia. He has more than 45 years of experience under his belt in manufacturing of home products and PU foam industry. The Sleepwell Foundation, set up by Mr. Gautam, caters to various Corporate Social Responsibility initiatives in education and sports. IITK conferred upon him the Distinguished Alumnus Award (2017).

Prof. Tanmoy Maiti from the Department of Material Science & Engineering, IIT Kanpur, has research interests in the areas of electronic materials, nanophotonics, and next-generation energy and memory devices. He has been recognized with several national and international honors, including the P.K. Kelkar Young Faculty Research Fellowship, IEI Young Engineers Award. Dr. Maiti holds a PhD in Materials Science and Engineering from Pennsylvania State University.

Current Occupant



Prof. Tanmoy Maiti
(Oct 2024 - Sept 2027)

RAJ AND NEERA SINGH CHAIR



Dr. Rajendra Singh and Dr. Neera Singh instituted the Raj and Neera Singh Chair under their names. Dr. Rajendra Singh (BT/EE/1975), is an entrepreneur who founded the Lightbridge Communications Corporation (LCC) International, a world leader in providing wireless voice and data turn-key services to the telecommunications industry along with his wife, Dr. Neera Singh. Dr. Singh has been instrumental in the academic and professional development of the wireless telecommunications industry.

Prof. Naveen Tiwari from the Department of Chemical Engineering, IIT Kanpur, research interests in the areas of transport phenomena, instabilities in micro-scale free surface flows, flow through porous media, numerical modeling and simulation. Prof. Tiwari earned his doctorate from the University of Massachusetts, USA in 2008. He was awarded the Young Scientist Research Award in 2014 by BRNS, DAE (Board of Research in Nuclear Sciences, Department of Atomic Energy), Young Faculty Research Award in 2017 and 2020, and the Excellence in Teaching Award in 2019 by IIT Kanpur.

Current Occupant



Prof. Naveen Tiwari
(July 2022 - July 2025)

RANJIT SINGH CHAIR



Late Dr. Ranjit Singh (BT/MME/1965) set-up the Ranjit Singh Foundation at IIT Kanpur that supports Ranjit Singh Chair. Dr. Singh started his career by working in a semiconductor industry in the Silicon Valley and later shifted to Allied Chemicals. He was the leader in developing cubic zirconia in 1979 and soon became a worldwide leader in artificial diamonds. Dr. Singh started his own company, Ranjit Singh Corp. in New Jersey, and was the supplier of artificial diamonds, jewellery and other precious gems. He earned his doctorate from MIT, USA.

Prof. Krishanu Biswas from the Department of Materials Science & Engineering, IIT Kanpur, has research interests in the areas of solidification of multicomponent alloys, nanostructured materials & energy materials. He is the recipient of the Young Scientist Medal by Indian National Science Academy (2010), Young Engineer Award by Institution of Engineers India (2011), BOYSCAST fellowship by Dept. of Science and Technology, Govt. of India (2011). He completed his Masters and PhD from IISc, Bangalore.

Current Occupant



Prof. Krishanu Biswas
(July 2022 - July 2025)

RANJIT SINGH CHAIR FOR ROZI SHIKSHA KENDRA



Late Dr. Ranjit Singh (BT/MME/1965) set-up the Ranjit Singh Foundation at IIT Kanpur that supports Ranjit Singh Chair for Rozi Shiksha Kendra. Dr. Singh started his career by working in a semiconductor industry in the Silicon Valley and later shifted to Allied Chemicals. He was the leader in developing cubic zirconia in 1979 and soon became a worldwide leader in artificial diamonds. Late Dr. Singh started his own company, Ranjit Singh Corp. in New Jersey and was the supplier of artificial diamonds, jewellery and other precious gems. He earned his Doctorate from MIT, USA.

Prof. Sandeep Sangal from the Department of Material Science & Engineering, IIT Kanpur, has research interests are physical and mechanical metallurgy and academic interests are structure-property correlations, microstructural characterization, stereology, image analysis, development of web-based educational Aids. He graduated from IIT Kanpur in 1982 and subsequently went on to earn his M.S. and PhD degrees from University of Manitoba in 1985 and 1989 respectively.

Current Occupant

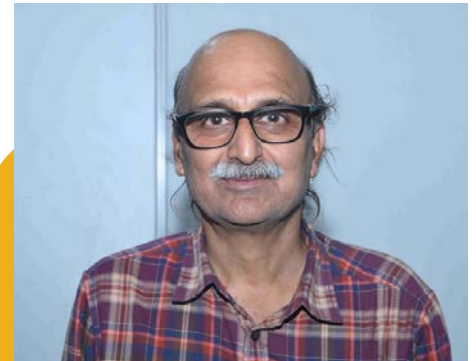

Prof. Sandeep Sangal
(Dec 2023 - Dec 2025)

RAJEEVA AND SANGEETA LAHRI CHAIR



Dr. Rajeeva Lahri with his wife, Mrs. Sangeeta Lahri, instituted the Rajeeva and Sangeeta Lahri Chair. This chair is open to all science and engineering faculty working in energy, infrastructure, or areas focused on improving quality of life in India. Dr. Rajeeva Lahri (MSC/PHY/1975) currently serves as an Advisory Board Member at Mojo Vision and Strategic Advisor at NanoDx, Inc. He previously held leadership roles including Vice President, Mobility & Wireless Business Unit in California, Founder & CEO of Signet Solar Inc., CTO & Executive Vice President at Intersil Corp, and Senior Vice President of Corporate Technology at VLSI Technology Inc. He also held technical and management positions at National Semiconductor and Hewlett-Packard.

Dr. Lahri earned his Ph.D. in Electrical Engineering from the State University of New York at Buffalo.

Current Occupant

Prof. Dharendra S. Katti from the Department of Biological Sciences & Bioengineering, IIT Kanpur, has research interests in the areas of biomaterials, controlled drug delivery systems, tissue engineering and nano-biotechnology. He earned his doctorate from Mumbai University.



Prof. Dharendra S. Katti
(July 2022 - July 2025)

RAJIV AND RITU BATRA ENDOWED CHAIR FOR CYBER SECURITY



Mr. Rajiv Batra (BT/EE/1982) instituted the Rajiv and Ritu Batra New Faculty Chair. Mr. Batra is a Founder of Palo Alto Networks and was responsible for building and leading the engineering department from inception. At Palo Alto Networks he held many positions including Founder, Member Office of CEO and Senior Vice President of Engineering. Palo Alto Networks is the largest independent enterprise security company in the world. Prior to founding Palo Alto, Mr. Batra was the Vice President of Engineering at Peribit Networks. Peribit Networks built industry leading products in the area of WAN Optimization and WAN Acceleration. It was acquired by Juniper Networks in July of 2005. Dr. Batra was also the Founder and VP of Engineering at VitalSigns Networks that was later acquired by International Network Services in 1998.

Mr. Batra was awarded the 2012 Entrepreneurial Achievement Award by University of Wisconsin-Madison. He is also a chair of the Board of Visitors of the Computer Science Department at University

of Wisconsin-Madison, Board Member of University of Wisconsin Foundation and a Trustee of Honolulu Museum of Art. Mr. Batra holds an MS degree in Computer Sciences from the University of Wisconsin, Madison, 1983. IITK conferred upon Dr. Rajiv Batra the Distinguished Alumnus Award 2020.

Current Occupant

Prof. Sandeep Kumar Shukla from the Department of Computer Science & Engineering, IIT Kanpur, has research interests in cyber security, embedded systems, critical infrastructures, formal methods, embedded software and hardware design, system level languages, smart grid, smart infrastructures. He is a IEEE Fellow (2014), ACM Distinguished Scientist (2013) and recipients of many awards such as Humboldt Bessel Award (2008), Distinguished Alumni Award in Science and Technology, State University of New York, Albany, June (2007), GTE Labs Excellence Award (1998), National Science Foundation CAREER Award, (2002), B.C. Roy Gold Medal for First Position among All Engineering Bachelor's Program, Jadavpur University (1992). He graduated from Jadavpur University in Computer science in 1991 and Master of Science from State University of New York, Albany.



Prof. Sandeep Shukla
(June 2023 - June 2026)

S.B.I. CHAIR



SBI instituted the State Bank of India Chair on energy & environment with special emphasis on innovations in the field of solar energy. The State Bank of India is a multinational public sector bank. Headquartered in Mumbai, Maharashtra, it is a government corporation statutory body. The Bank has over 24000 branches in India and 191 overseas offices in over 36 countries in the world. SBI is ranked as 236th in the Fortune Global 500 list of the world's biggest corporations of 2019. It is the largest bank in India with a 23% market share in assets, besides a share of one-fourth of the total loan and deposits market.

Prof. Avinash Kumar Agarwal from the Department of Mechanical Engineering, IIT Kanpur, has research interests in IC engines, combustion, conventional fuels, alternative fuels, methanol fuelled engine development, hydrogen, LCA and TCO analyses, fuel sprays, lubricating oil tribology, optical diagnostics, laser ignition, HCCI, particulate and emission control, and large bore engines.

Prof. Avinash Kumar Agarwal, a distinguished researcher in energy and combustion, has received numerous accolades, including the Shanti Swarup Bhatnagar Prize (2016), Sir J. C. Bose National Fellowship (2019), and Clarivate Analytics India Citation Award (2017). He has also been recognized with several young scientist and engineering awards from DST, INSA, INAE, and others. He is an elected Fellow of prestigious bodies such as SAE International, ASME, INAE, RSC, AAAS, and the Combustion Institute. Prof. Agarwal earned his Ph.D. in Energy from IIT Delhi in 1996.

Current Occupant



Prof. Avinash Kumar Agarwal
(April 2022 - April 2025)

SAJANI KUMAR ROY MEMORIAL CHAIR



Mr. Ranodeb Roy (BT/CSE/1990) instituted the Sajani Kumar Roy Memorial Chair that is open to faculty of all the departments of sciences at IIT Kanpur. Mr. Roy is the co-founder and CEO of RV Capital Management Private Limited, an asset management company based in Singapore. Mr. Roy has over 28 years of global Financial Markets experience. Prior to setting up RV Capital, a company he founded in 2011, Mr. Roy was Managing Director & Head of Fixed Income Asia Pacific at Morgan Stanley in Hong Kong. He has also worked in Merrill Lynch Hong Kong as Managing Director & Co-head of Fixed Income Currency and Commodities (FICC) group in 2007, and also held various senior positions in Merrill Lynch across major locations including New York, Tokyo and Hong Kong. Mr. Roy started his career at Bank of America, Mumbai in 1992.

Current Occupant

Prof. Nisanth Narayanan Nair from the Department of Chemistry, IIT Kanpur, has research interests in computational chemistry and modeling complex chemical reactions accurately. The techniques developed by him have applications in drug discovery, predicting protein structures, and understanding enzymatic and other catalytic reactions. He received the Young Scientist Medal from Indian National Science Academy (INSA), New Delhi (2013). He completed his MSc in Chemistry from IIT Madras in 2001 and PhD from University of Hannover, Germany in 2004.



Prof. Nisanth Narayanan Nair
(July 2022 - July 2025)

SANJAY MITTAL CHAIR



Mr. Sanjay Mittal (BT/EE/1975) and his wife, Priti Mittal instituted the Sanjay Mittal Chair that is open to all faculty of sciences and engineering working in the areas of innovative computational algorithms. Mr. Sanjay Mittal is the Founder and CEO of Predictika. He is a highly successful entrepreneur and an accomplished AI technologist. Mr. Mittal started his career as a research scientist at Xerox Palo Alto Research Center (PARC) with notable work in Artificial Intelligence and Constraint Reasoning. He was the President and CEO of Selectics Inc., a pioneer in internet sales and configuration solutions for large enterprises using AI constraint-reasoning technologies, where he built the company from scratch to a very successful \$5B IPO in 2000. He was the co-founder and CTO of Spozot, the leader in location-based delivery of retail offers over mobile devices. Mr. Mittal has had an illustrious career as a seasoned executive and has managed relationships with some of the largest companies in manufacturing, retail and insurance.

Current Occupant

Prof. Shalabh from the Department of Mathematics & Statistics, IIT Kanpur, has research interests in statistics and econometrics. His research interests include linear regression models, econometric modelling, measurement error models, missing data models, and panel data models. He received the Distinguished Statistician Award from the Indian Society for Probability and Statistics (ISPS), the National e-Governance Award (Silver) in 2022, and the Vigyan Ratna Samman from the Council of Science & Technology, Government of Uttar Pradesh, in 2018. He earned his doctorate in Mathematical Statistics from the University of Lucknow in 1996.



Prof. Shalabh
(Nov. 2022 - Nov. 2025)

SHRI JAGDEO NARAIN GUPTA & SMT. MURTI DEVI GUPTA CHAIR



Mr. Jitendra Nath (BT/EE/1977) Gupta instituted **Shri Jagdeo Narain Gupta & Smt. Murti Devi Gupta Chair** in memory of his parents. This chair is open to all departments of Sciences and Engineering at IITK. Mr. Jitendra Nath Gupta is the former Executive Director, Securities and Exchange Board of India in Mumbai. Prior to this, Mr. Gupta has served as the Group CFO of Kazstroy Service Group. Mr. Gupta has held senior positions in State Bank of India, Grasim Industries Limited, Indo Gulf Fertilisers and Kazstroy Service Group and has worked in SEBI from July 1994 to July 1996. A B.Tech in Electrical Engineering from IIT, Kanpur, Mr. Gupta also holds qualifications in CAIIB and Certified Financial Analyst (CFA).

Current Occupant

Prof. Yogesh Singh Chauhan from the Department of Electrical Engineering, IIT Kanpur, has research interests in Nanoelectronics Compact modeling of semiconductor devices (Bulk/SOI MOSFET, Multigate FET, Nanowire, UTBSOI and novel devices) SPICE Modelling of High Voltage/Power Semiconductor Devices (LDMOS, VDMOS, IGBT, HEMT etc.) BSIM model development and support (with BSIM Group at University of California Berkeley) Atomistic Simulation of Nanoscale Devices. He received the IBM Faculty Award (2013), Ramanujan Fellowship (2012), and an Honorable Mention at IEEE VLSI (2008). He earned his M.Tech from IIT Kanpur and Ph.D. from EPFL, Switzerland, in 2007. He completed M.Tech from IIT Kanpur and PhD from Ecole Polytechnique Federale de Lausanne (EPFL), Switzerland in 2007.



Prof. Yogesh Singh Chauhan
(June 2024 - June 2027)

MR. SANJAY PRADHAN & MS. RACHNA PRADHAN CHAIR



Mr. Sanjay Pradhan and Mrs. Rachna Pradhan have jointly instituted the **Sanjay & Rachna Pradhan Chair**. This Chair is open to any faculty from all the departments of sciences & engineering. Mrs. Rachna Pradhan (BT/EE/1985) is the Co-founder and CTO of Max Secure Software. With over 20 years of experience, Mrs. Pradhan has successfully managed projects providing varied solutions in the field of R&D, design, manufacturing Q&A / Resting in

diverse technology spheres.

Mr. Sanjay Pradhan (BT/CHE/1986) is the Founder & CEO of Max Secure Software. With a career spanning over two decades, Mr. Pradhan began his career in the US with companies working in the areas of Real Time Dynamic Simulation, AI, designing & deploying Control systems using Batch Processes. At Max Secure Software, Mr. Pradhan oversees business strategy, marketing & product development. He earned his MS from Carnegie Mellon University, Pennsylvania in AI & Optimization.

Current Occupant

Prof. Kumar Vaibhav Srivastava from the Department of Electrical Engineering, IIT Kanpur, has research interests in meta-materials, microwave antennas, MIMO antennas, microwave absorbers, finite-difference time-domain (FDTD) technique and microwave cloaking. He has been involved in research projects with DST, ISRO, DRDO, MHRD, GE, and others. He received the IEI Young Engineer Award (2014–15), IIT Kanpur's Excellence in Teaching Award (2020), and two faculty fellowships the Class of 1979 Research Fellowship (2013) and Dr. Shukla Faculty Fellowship (2017). He earned his Ph.D. in Electrical Engineering from IIT Kanpur in 2008.



Prof. Kumar Vaibhav Srivastava
(April 2022 - April 2025)

SATISH CHANDRA AGARWAL CHAIR



Mr. Kamal Agarwal instituted (BT/CHE/1972) the Satish Chandra Agarwal Chair in honor of his father. This Chair is open to all the departments of sciences & engineering at IITK. Late Mr. Kamal Agarwal received his MBA in Finance from the University of Maryland in 1975. He joined a Washington based company of Ship Brokers dealing primarily with United States Government Food Aid Programs and became a partner in the firm in 1983. In 1991, he founded a new ship brokerage company, Phoenix Chartering Inc. in Washington. He sold the company and retired in January 2005.

Current Occupant

Prof. J. Ramkumar from the Department of Mechanical Engineering, IIT Kanpur, has research interests in micro and nano manufacturing, sustainable and frugal new product and process development. His prime interest and focus is to ideate, and develop, medical innovations that support the development of the society and facilitate smooth lifestyle for the specially abled. He is recipient of several fellowships such as Young Engineer award of Information Sharing and Analysis Center (ISAC), India and Gopal Das Bhandari Best teacher Award by IIT Kanpur. He completed his doctorate from IIT Madras in 2003.

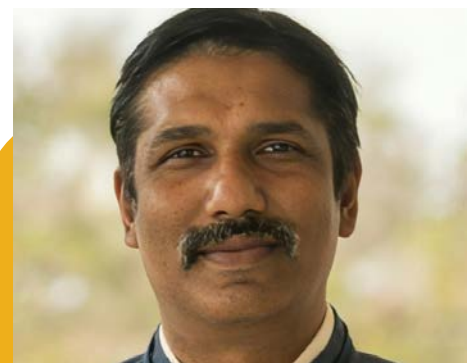

Prof. J Ramkumar
(April 2022 - April 2025)

SIR M. VISVESVARAYA CHAIR



जल शक्ति मंत्रालय MINISTRY OF JAL SHAKTI

To honor the renowned engineer and Bharat Ratna awardee, Sir M. Visvesvaraya, the **Ministry of Jal Shakti has instituted the Sir M. Visvesvaraya Chair**. The Ministry of Jal Shakti (Water Resources) is responsible for formulating policies and programs for the development and regulation of India's water resources. It oversees planning, coordination, and policy guidance in the sector, and provides technical support, evaluation, clearance, and monitoring of major and medium irrigation, flood control, and multi-purpose water projects.

The objective of this chair is to advance research in water resources, with a special focus on assessing the impact of climate change and developing adaptation strategies for the planning, design, and management of water resource systems, particularly in the Ganga basin.

Current Occupant

Prof. Sachchida Nand Tripathi is the inaugural Dean of Kotak School of Sustainability at IIT Kanpur, and Professor in the Department of Civil Engineering and jointly with the Department of Sustainable Energy Engineering, IIT Kanpur. His research interests are in aerosol science and technology, low-cost sensors for air quality monitoring, air pollution source identification in near real-time, aerosol-land use-rainfall-climate coupling, Large-Scale chamber aerosol experiments for reactor safety. He has received several prestigious honors, including the J.C. Bose Fellowship, Infosys Prize, UP Ratna Award, and fellowships of INSA and IASS Potsdam. Prof. Tripathi obtained his B. Tech from IIT BHU in Civil Engineering in 1992 and Ph.D. in Atmospheric Physics from the University of Reading, UK in 2001.



Prof. Sachchida Nand Tripathi
(June 2024 - June 2027)

SMT. LATA AND SHRI K G KARANDIKAR FACULTY CHAIR



Mr. Ashish Karandikar (BT/EE/1995) established the Smt. Lata and Shri K. G. Karandikar Faculty Chair in the Department of Electrical Engineering at IIT Kanpur. This Chair is aimed at fostering innovation, academic excellence, and research-driven growth within the department. Mr. Karandikar is the Vice President of Engineering at NVIDIA, Santa Clara, California, USA. He joined NVIDIA in 2003 and has since played a significant role in the company's technological advancement.

Current Occupant

Prof. Nishchal Kumar Verma from the Department of Electrical Engineering, IIT Kanpur, has research interests in artificial intelligence, machine learning, large language models (LLMs), intelligent instrumentation, control and automation, computer vision, and cyber-physical systems. He has been recognized with Teaching Excellence Award (2024), and research fellowships from UNEC Azerbaijan (2023) and the University of Tennessee (2010, 2022), along with the Devendra Shukla Fellowship (2013).



Prof. Nishchal Kumar Verma
(Oct. 2024 - Sep. 2027)

THE PAWAN TEWARI GOLDMAN SACHS SUSTAINABILITY FACULTY CHAIR



Mr. Pawan Tewari instituted the Pawan Tewari Goldman Sachs Sustainability Faculty Chair to support research, teaching, and academic leadership in the critical areas of freshwater preservation, environmental pollution, and sustainability, aiming to address the urgent challenges impacting human and planetary health. Mr. Tewari is currently working as the Managing Director in investment banking at Goldman Sachs & co-heads the Technology Mergers & Acquisition business based out of San Francisco, CA, USA. He earned his B.Tech in Electrical Engineering from IIT Kanpur in 1988. Mr. Tewari has a strong interest in freshwater preservation and the pressing challenges of soil, water, and air pollution.

Current Occupant

Prof. Tarun Gupta from the Department of Civil Engineering, IIT Kanpur, has research interests in environmental engineering, atmospheric chemistry, air pollution and control, engine emissions, aerosol instrumentation, human health, and risk assessment. His contributions have been recognized through several prestigious awards, including the INAE Innovator and Entrepreneur Award (2018), NASI Scopus Young Scientist Award (2015), INSA Medal for Young Scientist (2011), INAE Young Engineer Award (2009), and the IEI Young Engineer Award (2008). He holds an M. Tech from IIT Bombay and a Ph.D from Harvard University.



Prof. Tarun Gupta
(July 2022 - July 2025)

SONU AGARWAL MEMORIAL CHAIR

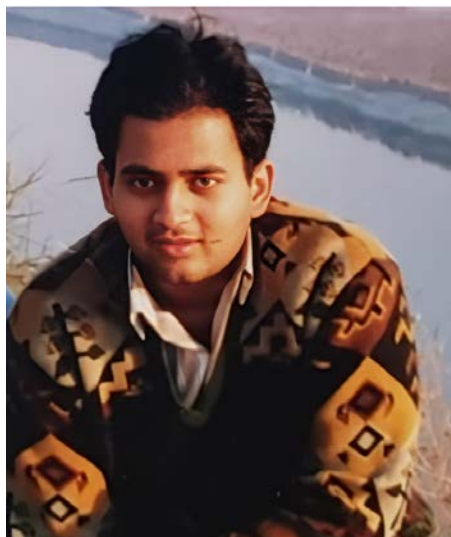

In loving memory of Sonu Agarwal, an alumnus of IIT Kanpur, his batchmates launched a campaign to institute a faculty chair in his name. Following his untimely passing, his batchmates came together to establish this chair as a lasting tribute to his life and contributions.

Prof. Arun Shukla from the Department of Biological Sciences & Bioengineering, IIT Kanpur, has research interests in G protein-coupled receptors (GPCRs), a key class of cell surface receptors involved in vital functions like vision, cardiovascular regulation, and immune response. Nearly half of all prescribed drugs target these receptors. His research aims to understand their structure and function to develop safer, more effective therapeutics. Dr. Shukla has made significant contributions to GPCR biology at IIT Kanpur. He holds an M.Sc. from JNU and a Ph.D. from the Max Planck Institute of Biophysics, Germany.

Current Occupant



Prof. Arun Shukla
(June 2023 - June 2026)

TAPAS MISHRA MEMORIAL CHAIR IN COMPUTER SCIENCE AND ENGINEERING



The Tapas Mishra Memorial Chair in Computer Science and Engineering has been instituted by the Computer Science and Engineering Class of 1997 in memory of their batchmate, the late **Mr. Tapas Mishra**. He was a dear friend and a respected, talented, and hard-working peer of the batch. He passed away at an early age, and the Class of 1997 chose to honour his memory by instituting this Chair. The purpose of the Chair is to accelerate the recipient's career and amplify the impact of their research to a level of international leadership.

Current Occupant

Prof. Surender Baswana from the Department of Computer Science & Engineering, IIT Kanpur, has research interests in design and analysis of computer algorithms, especially, graph algorithms, dynamic algorithms, streaming algorithms. He completed his PhD from IIT Delhi in 2005. He is a recipient of the Alexander von Humboldt Fellowship for Experienced Researchers in 2018, Young Engineer Award in 2009.



Prof. Surender Baswana
(July 2022 - July 2025)

USV CHAIR



Mr. Prashant Tiwari and Mrs. Leena Gandhi Tiwari instituted the USV Chair. This chair is open to all departments of science and engineering at IIT Kanpur. Mr. Prashant Tiwari (BT/ME/1979) is the Managing Director of USV Pvt. Ltd., an Indian multinational pharmaceutical and biotechnology company headquartered in Mumbai, Maharashtra. USV is a leading player in the diabetes and cardiovascular segments in India. The company was founded by Vithal Balkrishna Gandhi, grandfather of Mrs. Leena Gandhi Tiwari, who currently serves as its Chairperson. USV's R&D efforts focus on small-molecule active pharmaceutical ingredients, biosimilars, and custom research services for drug development.

Prof. Tapobrata Sarkar from the Department of Physics, IIT Kanpur, has research interests in high energy physics specializing in theories of quantum gravity and astrophysical signatures of gravity. He is the recipient of many awards such as the IRCC Research & Industrial Consultancy Award, IIT Bombay: Best Paper award of 2006 (paper reviewed by Nobel Laureate), P. K. Kelkar Fellowship, IIT Kanpur (2009-2012). He completed his PhD from Institute of Mathematical Sciences, Chennai in 1999.

Current Occupant



Prof. Tapobrata Sarkar
(July 2022 - July 2025)

UMANG GUPTA CHAIR



Mr. Umang Gupta (BT/CHE/1971) instituted the Umang Gupta Chair. This chair is open to all the departments of sciences and engineering at IIT Kanpur. Late Mr. Umang Gupta was a pioneering Indian-American entrepreneur and Silicon Valley leader, best known as the former Chairman and CEO of Keynote Systems and founder of Gupta Technologies. A 1971 graduate of IIT Kanpur, he was conferred with the Distinguished Alumnus Award in 1997 for his outstanding contributions to information technology and entrepreneurship. Mr. Gupta began his career at IBM and later joined Oracle Corporation as its 17th employee, where he authored the company's first business plan. He went on to establish Gupta Technologies, a leading client/server database company, and later led Keynote Systems, a global player in internet and mobile performance analytics.

Widely recognized as an authority in SQL and database systems, he also co-authored one of the earliest SQL guides. Beyond his

professional achievements, he was deeply committed to civic and philanthropic work, serving on the boards of the Peninsula Community Foundation and the Smithsonian Asian Pacific American Center. Together with his wife, Ruth, he supported organizations like PARCA and helped establish Raji House, a respite home for the developmentally disabled.

Current Occupant

Prof. Rajesh Hegde from the Department of Electrical Engineering, IIT Kanpur, has research interests in speech signal processing and recognition of Indian languages, sensor array and multichannel signal processing, multi microphone speech processing and distant speech recognition. He has also worked as a researcher & lecturer at the California Institute of Telecommunications & Information Technology, University of California, San Diego. Prof. Hegde earned his doctorate from IIT Madras in 2005.



Prof. Rajesh Hegde
(April 2022 - April 2025)

YADUPATI SINGHANIA MEMORIAL CHAIR



J.K. Cotton Limited instituted Yadupati Singhania Memorial Chair. This Chair is open to any of the Engineering Departments, IIT Kanpur. Late Mr. Yadupati Singhania (BT/CE/1977) was a renowned industrialist and philanthropist, best known for transforming J.K. Cement Ltd. into a leading name in India's cement industry. Under his leadership, the company established six major plants across the country, creating widespread employment and contributing significantly to infrastructure development.

A proud alumnus of IIT Kanpur, Mr. Singhania remained deeply connected to the institute. He generously supported several initiatives, including the C.V. Seshadri Chair and the SPIC MACAY National Convention. In recognition of his remarkable contributions to industry and society, he was honoured with the Distinguished Alumnus Award by IIT Kanpur.

Current Occupant

Prof. Kantesh Balani from the Department of Materials Science and Engineering, IIT Kanpur, has research interests in multi-functional biomaterials, nanomechanics, nanotribology, polymeric/ceramic nanocomposites, ultra-high temperature ceramics, and energy materials. He is a recipient of several prestigious honors, including the Swarnajayanti Fellowship (2016–17), Metallurgist of the Year (2016), and fellowships from ASM International (FASM, 2021), INAE (FNAE, 2021), and NASI (FNASc, 2021). He has also received numerous young scientist and engineering awards from leading national and international bodies. Prof. Balani earned his Ph.D. in Mechanical Engineering from Florida International University, USA, in 2007.



Prof. Kantesh Balani
(April 2022 - April 2025)

LIST OF FACULTY CHAIRS

S. No.	Name of the Chair	Name of the Donor
1	Air Vice Marshal Harjinder Singh, VSM Class I MBE, Chair of Excellence	Indian Air Force, Air Headquarter, New Delhi
2	Arun Kumar Chair	Family & Friends of late Mr. Arun Kumar
3	Arjun Dev Joneja Faculty Chair	Dr. Dev Joneja (BT/ME/1984)
4	Prof. B. B. Lal Chair	Mr. Vrajesh Lal (BT/MME/1970)
5	BIS Standardization Chair	Bureau of Indian Standards
6	Champa Devi Gangwal Chair	Mr. Rakesh Gangwal (BT/ME/1975)
7	Chevron Corporation Chair	Mr. Jagjeet Singh Bindra (BT/CHE/1969)
8	Prof. C.V. Seshadri Chair	Relatives & Friends of late Mr. C.V. Seshadri
9	Class Of 1984 Chair	Class of 1984
10	Shri Deva Raj Chair	Mr. Deepak Raj (BT/EE/1970)
11	Dr. S. Sampath Chair	Family & Friends of Prof. S. Sampath
12	Dr. Jag Mohan Garg Chair	Mr. Sudhir Mittal (BT/CHE/1970)
13	Gireesh Jankinath Chair	Mr. Ravindra Nath Akhoury (BT/EE/1968)
14	Gurumukh Mehta Chair	Dr. Gurumukh Mehta & Veena Mehta (MT/ME/1969)
16	HAL Chair	Hindustan Aeronautics Limited (HAL)
17	Institute Chair Professor	IIT Kanpur
18	Indian Oil Golden Jubilee Professional Chair	India Oil Corporation Govt. of India
19	Jainendra Navlakha (1974) Chair	Prof. Jainendra Navlakha (MT/EE/1974)
20	Joy Gill Chair	Mr. Ajit S. Gill (BT/EE/1969)
21	KENT Entrepreneurship & Innovation Chair	Dr. Mahesh Gupta (BT/ME/1975)
22	Lalit Mohan Kapoor Chair	Mr. Lalit M Kapoor (BT/CHE/1971)
23	Ministry of skill development entrepreneurship (MoSDE)	Ministry of Labour and Employment
24	Mr. & Mrs. Gian Singh Bindra Chair	Mr. Jagjeet Singh Bindra (BT/CHE/1969)
25	N Rama Rao Chair	Mr. N. R. Narayana Murthy (MT/EE/1969)

26	Next Generation Broadcasting Faculty Chair	One Media 3.0 LLC
27	Om Prakash Gautam Faculty Chair	Dr. Rajeev Gautam (BT/CHE/1974)
28	Pandit Girish Ranjan & Sushma Rani Pathak Chair	Mr. Kamlesh Dwivedi (BT/EE/1979)
29	Pandit Ramchandra Dwivedi Chair	Mr. Kamlesh Dwivedi (BT/EE/1979)
30	Pradeep Sindhu Chair	Mr. Pradeep Sindhu (BT/EE/1974)
31	P. K. Kelkar Chair	IIT Kanpur
32	Pavitar Joneja Chair	Dr. Dev Joneja (BT/ME/1984)
33	Poonam & Prabhu Goel Chair (Poonam & Prabhu Goel Foundation)	Mrs. Poonam & Prabhu Goel (BT/EE/1970)
34	Prof. N. C. Nigam Chair	Family & Friends of late Prof. N.C. Nigam
35	Prof. R.N. Biswas Chair in Teaching Excellence	IIT Kanpur Alumni
36	Prof. T R Viswanathan Chair in Teaching Excellence	IIT Kanpur Alumni
37	Raj & Neera Singh Chair	Mrs. Neera Singh, Dr. Rajendra Singh (BT/EE/1975) (BT/CHE/1981)
38	Ranjit Singh Chair	Dr. Ranjit Singh (BT/MME/1965) (Ranjit Singh Foundation)
39	Ranjit Singh Chair for Rozi Siksha Kendra	Dr. Ranjit Singh (BT/MME/1965)
40	Rahul & Namita Gautam Chair	Mr. Rahul Gautam (BT/CHE/1975)
41	Rajeeva & Sangeeta Lahri Chair	Mr. Rajeeva Lahri (MSc/PHY/1975) & Family Foundation
42	Rajiv and Ritu Batra Endowed Chair for Cyber Security	Shri Rajiv Batra & Mrs. Ritu Batra (BT/EE/1982)
43	S.B.I. Chair	State Bank of India
44	Sajani Kumar Roy Memorial Chair	Mr. Ranodeb Roy (BT/CSE/1990)
45	Sanjay Mittal Chair	Mr. Sanjay Mittal (BT/EE/1975)
46	Jagdeo Narain Gupta & Smt. Murti Devi Gupta Chair	Mr. J. N. Gupta (BT/EE/1977)
47	Sanjay & Rachna Pradhan Chair	Mr. Sanjay Pradhan (BT/CHE/1986) Ms. Rachana Pradhan (BT/EE/1995)
48	Satish Chandra Agarwal Chair	Late Mr. Kamal Agarwal (BT/CE/1972)
49	Satya and Rao Remala Foundation Chair	Satya and Rao Remala Foundation
50	Sir M. Visvesvaraya Chair	Ministry of Water Resources Govt. of India
51	Smt. Lata and Shri K G Karandikar Faculty Chair	Mr. Ashish Karandikar (BT/EE/1995)
52	The Pawan Tewari Goldman Sachs Sustainability Faculty Chair	Shri Pawan Tewari (BT/EE/1988)
53	Sonu Agarwal Memorial Chair	Batch of 1993-1997
54	Tapas Mishra Memorial Chair in Computer Science and Engineering	Parents & friends of late Mr. Tapas Mishra

55	USV Chair	Mr. Prashant Tiwari (BT/ME/1979)
56	Umang Gupta Chair	Mr. Umang Gupta (BT/CHE/1971)
57	Yadupati Singhanian Memorial Chair	J K Cotton Limited
58	Ram Tiwari Chair	Dr. Kamal K Tiwari (BT/ME/1973) & Gloria Tiwari
59	Jal Jivan Mission Professor Chair	Ministry of Jal Shakti
60	Soma and Manas Mandal Chair	Dr. Manas Mandal (BT/CSE/1985) and Dr. Soma Mandal
61	Golden Jubilee Chair on Entrepreneurship & Innovation	Mr. Sujit Kumar (BT/MT/CE/1992/1994)
62	Ministry of Steel Chair	Ministry of Steel Chair
63	Ministry of Earth Science (D. N. Wadia) Chair	Ministry of Earth Science

YOUNG FACULTY RESEARCH FELLOWSHIPS

Faculty Fellowships are awarded for a period of three years as young Faculty Research Fellowships to those who are below the age of 40 years and have made outstanding contributions in their research areas.

BATCH OF 1993 FACULTY FELLOWSHIP



The **batch of 1993** has generously contributed to institute this fellowship. It is awarded for a period of three years as Young Faculty Research Fellowships to those who are below the age of 40 years and have made outstanding contributions in their research areas.

Current Occupant

Prof. Dipak Kumar Giri from the Department of Aerospace Engineering, at IIT Kanpur, has research interests in spacecraft dynamics, control systems, and flight control. He played a key role in establishing the Space Dynamics and Flight Control Laboratory at IIT Kanpur. Dr. Giri is a recipient of several prestigious awards, including the Young Engineers Award (IEI), DST INSPIRE Faculty Award, Erasmus Mundus Fellowship (EU), and the Sakura Science Fellowship (Japan).



Prof. Dipak Kumar Giri
(Sep. 2024 - Sep. 2027)

CLASS OF 1973 YOUNG FACULTY FELLOWSHIP



The **Class of 1973** instituted the Young Faculty Fellowship that is open to all the departments of engineering and sciences, IIT Kanpur.

Current Occupant

Prof. Vishal Govind Rao from the Department of Chemistry, IIT Kanpur and has research interests in plasmonic photocatalysis, interfacial charge transfer dynamics, strategies for efficient solar energy utilization, and carbon dioxide reduction into hydrocarbon fuels. He earned his Ph.D. in Chemistry from IIT Kharagpur in 2013. Prof. Rao serves on the editorial boards of prestigious journals like Communications Materials (Nature) and Chemical Physics Impact.



Prof. Vishal Govind Rao
(Sep 2024 - Sep 2027)

CLASS OF 1979 YOUNG FACULTY FELLOWSHIP



Mr. Alok Agarwal (BT/EE/1979) is the Chief Financial Officer at Reliance Industries. He earned his management degree from IIM Ahmedabad in 1981. **Mr. Agarwal instituted the Class of 1979 Young Faculty Fellowship** that is open to all the departments of engineering and sciences, IIT Kanpur .

Current Occupant

Prof. Abheejeet Mohapatra from the Department of Electrical Engineering, IIT Kanpur has research interests in Optimization for operation and planning of power networks, AC and DC microgrid protection, Stability, security and control of power networks with renewable resources. Prof. Mohapatra received the INAE Young Engineer Award (2021) and the POSOCO Power Systems Award (2014) for the best PhD dissertation. He has led consultancy projects for NTPC NETRA, metro systems in Lucknow, Kanpur, Bhopal, and Indore, and transformer manufacturers. He earned his M. Tech. (2010) and Ph.D. (2014) in Electrical Engineering from IIT Delhi.



Prof. Abheejeet Mohapatra
(Sep. 2024 - Sep. 2027)

CLASS OF 1986 YOUNG FACULTY FELLOWSHIP



Class of 1986 Young Faculty Fellowship was instituted by Dr. Pramath Raj Sinha and is open to young faculty members of all the departments of IIT Kanpur. Dr. Pramath Raj Sinha (BT/MME/1986) is the Founder and Trustee of Ashoka University, Founding Senior Partner at Jetri, and Founder of the Vedica Scholars Programme for Women and Harappa Education. He was the Founding Dean of ISB (2001–2002) and a Partner at McKinsey & Company (1993–2006). He later led ABP Group, before founding 9.9 Group, where he currently serves as Managing Director. A key force behind the Young India Fellowship, Dr. Sinha has played a transformative role in higher education in India. He received the IITK Distinguished Alumnus Award in 2018 and holds a Master's and Ph.D. from the University of Pennsylvania.

Prof. Abhishek K. Gupta from the Department of Electrical Engineering, IIT Kanpur, has research interests in stochastic geometry and modern communication systems, including 5G, mmWave, THz, vehicular, and molecular communication. He received the IEEE Wireless Communication Letters Exemplary Reviewer Award (2016) and GE-FS Leadership Award (2009). He earned his dual B.Tech.–M. Tech. from IIT Kanpur in 2010 and Ph.D. from the University of Texas at Austin in 2016.

Current Occupant



Prof. Abhishek K. Gupta
(March 2022 - Feb. 2025)

DR. MAHUA MENON AND MR. RANODEB ROY YOUNG FACULTY RESEARCH FELLOWSHIP



Mr. Ranodeb Roy instituted Dr. Mahua Menon and Mr. Ranodeb Roy Young Faculty Research Fellowship that is open to faculty of all the departments of sciences and engineering, IIT Kanpur. Mr. Ranodeb Roy (BT/CSE/1990) is the co-founder and CEO of RV Capital Management Private Limited, an asset management company based in Singapore. With over 28 years of experience in global financial markets, he has held several leadership roles in major financial institutions. Prior to founding RV Capital in 2011, he served as Managing Director and Head of Fixed Income Asia Pacific at Morgan Stanley, Hong Kong. He also held senior positions at Merrill Lynch, including Managing Director and Co-Head of the FICC Group, working across key financial hubs such as New York, Tokyo, and Hong Kong. Mr. Roy began his career in 1992 at Bank of America, Mumbai.

Current Occupant

Prof. Manjesh Kumar Singh from the Department of Mechanical Engineering, IIT Kanpur and has research interests in tribology, soft matter and rheology and specializes in both computer simulations and experiments. He has received several international fellowships and the Young Tribologist Award from the Tribology Society of India in 2022. He holds a BE from IEST Shibpur (2009), an ME from IISc Bangalore (2011), and a Ph.D. from ETH Zurich (2016).



Prof. Manjesh Kumar Singh
(Sep. 2024 - Sep. 2027)

DR. SHUKLA NEW FACULTY FELLOWSHIP



Dr. Devendra Shukla (BT/CE/1967) is the founder of Innovative Technical Solutions Inc. (ITSI), one of the leading environmental and infrastructure firms in the northwestern United States. Under his leadership, ITSI grew into an award-winning global enterprise with extensive experience in engineering and construction projects for the U.S. Department of Defense, EPA, Department of Energy, and other agencies. In 2010, ITSI became a wholly owned subsidiary of Gilbane Building Company. In recognition of his entrepreneurial excellence and managerial acumen, IIT Kanpur honored him with the Distinguished Alumnus Award in 2009. Dr. Shukla instituted the **Dr. Shukla New Faculty Fellowship**.

Current Occupant

Prof. Sathesh Mariappan from the Department of Aerospace Engineering, IIT Kanpur, has research interests in combustion-acoustic interactions, rotorcraft aerodynamics, optical flow diagnostics, and scientific machine learning. He is the recipient of several prestigious honors, including the Young Engineer Awards from INAE, IEI, and ISEES, the International Exchanges Award from The Royal Society, London, and the Fulbright-Nehru Academic and Professional Excellence Fellowship.



Prof. Sathesh Mariappan
(May 2024 - April 2027)

SIR M. VISVESVARAYA RESEARCH FELLOWSHIP



The Ministry of Jal Shakti instituted Sir M. Visvesvaraya Research Fellowship in the honor of the famous architect and Bharat Ratna Awardee, Sir M. Visvesvaraya. The aim of this faculty chair is to carry out studies on water resources with special emphasis on the assessment of the effect of climate change on it, and adaptation strategies in respect of planning, design and management of water resource systems of India in general and the Ganga basin in particular. The Ministry of Jal Shakti (Water Resources) is responsible for laying down policy guidelines and programmes for the development and regulation of a country's water resources. It looks into the planning, policy formulation, coordination and guidance in the water resources sector. Its primary function is to provide technical guidance, scrutiny, clearance and monitoring of irrigation, flood control and multi-purpose projects (major/medium).

Prof. Gourabananda Pahar from the Department of Civil Engineering, IIT Kanpur, has research interests in the areas of hydraulics and water resources. His research interests are in the fields of Urban flood inundation, Shallow water models, and Incompressible Smoothed Particle Hydrodynamics. He graduated from Bengal Engineering and Science University, Shibpur in 2011 and earned his doctorate from IIT Kharagpur in 2017.

Current Occupant



Prof. Gourabananda Pahar
(May 2024 - April 2027)

PROF R N BISWAS YOUNG FACULTY FELLOWSHIP IN TEACHING EXCELLENCE



Established through the generous contributions of IITK alumni, this Fellowship honors Prof. R. N. Biswas, one of the institute's most esteemed faculty members. Born in 1939, he earned his B.Sc. in Physics from Presidency College, University of Calcutta (1957), followed by an M.Sc. (Tech) in Radio Physics and Electronics (1960). He completed his Ph.D. in Electronic Circuits from the University of California, Berkeley, in 1966 and joined IIT Kanpur as an Assistant Professor in 1967. The Fellowship acknowledges young and enthusiastic faculty members under 40 years of age who demonstrate excellence in teaching early in their careers and supports their efforts in developing new methods and pedagogical approaches.

Current Occupant

Prof. Suparno Mukhopadhyay from the Department of Civil Engineering, IIT Kanpur, and has research interests in structural health monitoring, structural dynamics and earthquake engineering. He earned his Bachelor's in Civil Engineering from Jadavpur University, Master's from IIT Kanpur, and Ph.D. in Engineering Mechanics from Columbia University.



Prof. Suparno Mukhopadhyay
(March 2023 - March 2026)

Current Occupant



Prof. Dootika Vats
(March 2023 - March 2026)

Prof. Dootika Vats from the Department of Mathematics and Statistics, IIT Kanpur, has research interests in markov chain monte carlo methods, output analysis for stochastic simulation, and more recently, stochastic optimization algorithms. She earned her Ph.D. in Statistics from the University of Minnesota, and a Master's in Statistics from Rutgers University. Dr. Vats is the recipient of several prestigious honors, including the Sushila and Kantilal Mehta Award (IIT Kanpur), the Google India Research Award, and the Blackwell-Rosenbluth Award.

WISE NEW FACULTY FELLOWSHIP



Dr. Anjali Joshi instituted WISE New Faculty Fellowship for a newly joined woman faculty member of any discipline at IIT Kanpur. Dr. Anjali Joshi (BT/EE/1981) is a prominent technology leader currently serving on the boards of Persistent Systems, Xero, and LocoNav, and advising institutions such as Insight Partners, the National AI Institute for Exceptional Education, the Markkula Center for Applied Ethics, and INSEAD. She has held senior leadership roles at AT&T Bell Labs, Covad Communications, and served as Vice President of Product Management at Google, where she led key initiatives including the Google Fiber project that brought ultra-high-speed broadband to communities across the U.S. At AT&T Bell Labs, she worked as Principal Member of Technical Staff, contributing to voice and high-speed data communication systems, including planning and implementing ATM/IP networks for AT&T's high-speed services. Dr. Joshi earned her B.Tech. in Electrical Engineering from IIT Kanpur (1981), a Master's in Computer Engineering from the State University of New York, and a Master's in Engineering Management from Stanford University.

Current Occupant

Prof. Pragathi Priyadharsini Balasubramani from the Department of Cognitive Science, IIT Kanpur, has research interests in intersection of cognitive, computational, and translational neuroscience. She leads the Translational Neuro Science and Technology (TRANSiT) Lab, which focuses on the science of cognitive brain-computer interfaces and the development of technologies for clinical applications and interventions. She is also associated with a startup, Neuro Clinical Innovative Solutions Pvt. Ltd., which develops clinical technologies for neurological disorders. She earned her Ph.D. from IIT Madras and has received several prestigious honors, including the Young Investigator Award from the Brain and Behavior Research Foundation (NARSAD) and an Innovative Research Award from the Kavli Institute of Brain and Mind.



Prof. Pragathi Priyadharsini Balasubramani
(March 2022 - Feb. 2025)

P. K. KELKAR (1982 BATCH FELLOWSHIP)



Dr. Purushottam Kashinath Kelkar (1909–1990) is best remembered as the founding Director of IIT Kanpur, established in 1959. Born in Karnataka, he graduated in Physics from the Royal Institute of Science, Mumbai in 1931 and earned a Diploma in Electrical Engineering from IISc Bangalore in 1934. He later obtained his Ph.D. from the University of Liverpool under the guidance of Dr. J. C. Prescott. His association with IITs began in 1956 as Planning Officer of IIT Bombay, where he later served as Deputy Director. In December 1959, he was appointed the first Director of IIT Kanpur, where he envisioned an interdisciplinary institute combining engineering, science, humanities, and research. He played a key role in establishing the Kanpur Indo-American Program (KIAP), a collaboration with nine U.S. universities that significantly contributed to IITK's development. In 1970, Dr. Kelkar became Director of IIT Bombay, introducing several initiatives that spurred its growth. For his outstanding contributions to technical education in India, he was awarded the Padma Bhushan in 1969.

Current Occupant

Prof. Anikesh Pal from the Department of Mechanical Engineering, IIT Kanpur, has research interests in Turbulence, Machine Learning, Computational Fluid Dynamics (CFD), Atmospheric and Oceanic flows and Climate dynamics. Prof. Pal received his doctoral degree from the University of California San Diego.



Prof. Anikesh Pal
(Sep. 2024 - Sep. 2027)

P.K. KELKAR (CLASS OF 1979 RESEARCH FELLOWSHIP FOR OUTSTANDING YOUNG FACULTY)



Dr. Purushottam Kashinath Kelkar (1909–1990) is best remembered as the founding Director of IIT Kanpur, established in 1959. Born in Karnataka, he graduated in Physics from the Royal Institute of Science, Mumbai in 1931 and earned a Diploma in Electrical Engineering from IISc Bangalore in 1934. He later obtained his Ph.D. from the University of Liverpool under the guidance of Dr. J.C. Prescott. His association with IITs began in 1956 as Planning Officer of IIT Bombay, where he later served as Deputy Director. In December 1959, he was appointed the first Director of IIT Kanpur, where he envisioned an interdisciplinary institute combining engineering, science, humanities, and research. He played a key role in establishing the Kanpur Indo-American Program (KIAP), a collaboration with nine U.S. universities that significantly contributed to IITK's development. In 1970, Dr. Kelkar became Director of IIT Bombay, introducing several initiatives that spurred its growth. For his outstanding contributions to technical education in India, he was awarded the Padma Bhushan in 1969.

Prof. Prakash Chandra Mondal from the Department of Chemistry, IIT Kanpur, has research interests in interfacial electrochemistry, molecular electronics, memory devices, molecular electrochromism, and spintronics. He has been a Member of the Royal Society of Chemistry (MRSC) since 2023 and is a life member of the Materials Research Society of India (MRSI), Chemical Research Society of India (CRSI), and the Indian Science Congress. Prof. Mondal completed his B.Sc. in Chemistry from Jadavpur University in 2006 and his M.Sc. from IIT Kharagpur in 2008. He earned his Ph.D. from the University of Delhi in 2013.

Current Occupant



Prof. Prakash Chandra Mondal
(May 2024 - April 2027)

Current Occupant



Prof. Srinivas Dharavath
(May 2024 - April 2027)

Prof. Srinivas Dharavath from the Department of Chemistry, IIT Kanpur, has research interests in organic chemistry, high energy density materials, energetic oxidizers, cocrystals, ionic liquids, iodine-rich compounds, and medicinal chemistry. His research focuses on nitrogen-rich, fused, and strained ring molecules for environmentally friendly high-energy materials used in defense and civilian sectors. He received the Dr. K. V. Rao Young Research Scientist Award in 2013. Dr. Dharavath completed his post-graduation from Osmania University in 2009 and earned his Ph.D. from the University of Hyderabad in 2014.

PK KELKAR FELLOWSHIP



Dr. Purushottam Kashinath Kelkar (1909–1990) is best remembered as the founding Director of IIT Kanpur, established in 1959. Born in Karnataka, he graduated in Physics from the Royal Institute of Science, Mumbai in 1931 and earned a Diploma in Electrical Engineering from IISc Bangalore in 1934. He later obtained his Ph.D. from the University of Liverpool under the guidance of Dr. J.C. Prescott. His association with IITs began in 1956 as Planning Officer of IIT Bombay, where he later served as Deputy Director. In December 1959, he was appointed the first Director of IIT Kanpur, where he envisioned an interdisciplinary institute combining engineering, science, humanities, and research. He played a key role in establishing the Kanpur Indo-American Program (KIAP), a collaboration with nine U.S. universities that significantly contributed to IITK's development. In 1970, Dr. Kelkar became Director of IIT Bombay, introducing several initiatives that spurred its growth. For his outstanding contributions to technical education in India, he was awarded the Padma Bhushan in 1969.

Prof. Supratik Banerjee from the Department of Physics, IIT Kanpur, has research interests in plasma physics and fluid turbulence. His research interests include Analytical theory of various types of turbulent flows, particularly in space and astrophysical fluid media, Theoretical modeling and in-situ data analysis of solar wind turbulence, Turbulence in living fluids. He is a recipient of the DST INSPIRE Faculty Research Grant.

Current Occupant



Prof. Supratik Banerjee
(Sep. 2024 - Sep 2027)

Current Occupant



Prof. Diptarka Das
(May 2024 - April 2027)

Prof. Diptarka Das from the Department of Physics, IIT Kanpur, has research interests in theoretical physics, focussing on non-equilibrium physics, and string theory. He earned a dual degree in Electrical and Electronics Engineering and M.Sc. in Physics from BITS Pilani in 2010, and a Ph.D. in Physics from the University of Kentucky in 2014.

Prof. Purushottam Kar from the Department of Computer Science & Engineering, IIT Kanpur, has research interests in the fields of machine learning, optimization, statistical learning theory and his research interests include online and stochastic learning and optimization, multi-label classification, high dimensional statistics, kernel methods and statistical learning theory. Prof. Kar completed his B.Tech and Ph.D. from IIT Kanpur in 2008 and 2014, respectively. He has received several honors, including the ICML Reviewer Award (2015), and IITK Academic Excellence Awards (2005, 2006).

Current Occupant



Prof. Purushottam Kar
(May 2024 - April 2027)

Current Occupant



Prof. Shubham Sahay
(May 2024 - April 2027)

Prof. Shubham Sahay from the Department of Electrical Engineering, IIT Kanpur, has research interests in hardware platforms for neuromorphic computing, hardware security primitives, novel device architectures for scaling cmos technology, analytical and compact modeling of semiconductor devices, non-volatile memories, and spintronics. Dr. Sahay is a recipient of the IEEE Electron Devices Society Early Career Award and Young Associate of the Indian National Academy of Engineering (INAE). He completed B.Tech in Electronics Engineering from IIT (BHU), Varanasi in 2014 and Ph.D. from IIT Delhi in 2018.

Prof. Vipul Arora from the department of Electrical Engineering, IIT Kanpur, has research interests in speech, music, and audio processing, including audio LLMs, speech recognition, and music analysis. His interests also include generative machine learning for computational physics, trustworthy AI, human-machine learning, and efficient ML techniques for audio and air quality monitoring. He received his B. Tech. (2009) and PhD (2015) degrees in Electrical Engineering from IIT Kanpur.

Current Occupant



Prof. Vipul Arora
(May 2024 - April 2027)

Prof. Arghya Das from the Department of Civil Engineering, IIT Kanpur, has research interests in granular material mechanics, flow through porous media, constitutive modeling of geomaterials, instability and bifurcation analysis, rock mechanics. He received his PhD in Civil Engineering from the University of Sydney, Australia, in 2013.

Current Occupant



Prof. Arghya Das
(July 2022 - June 2025)

Current Occupant



Prof. Arjit Kundu
(July 2022 - June 2025)

Prof. Arjit Kundu from the Department of Physics, IIT Kanpur, has research interests in equilibrium and non-equilibrium quantum transport, topological systems in condensed matter. He did his PhD in 2012 from Heinrich-Heine University, Duesseldorf, Germany.

Prof. Nitin Gupta from the Department of Biological Sciences and Bioengineering, IIT Kanpur, has research interests in systems neuroscience, olfaction, mental health. He earned his B.Tech. from IIT Kanpur (2004) and Ph.D. from UC San Diego. His awards include the Swarnajayanti Fellowship (2021), Excellence-in-Teaching Award (2019), Wellcome Trust/DBT Fellowship (2016), and others.

Current Occupant



Prof. Nitin Gupta
(July 2022 - June 2025)

Current Occupant



Prof. Raju Kumar Gupta
(July 2022 - June 2025)

Prof. Raju Kumar Gupta from the Department of Chemical Engineering, IIT Kanpur, has research interests in photocatalysis, green synthesis of nanomaterials and surface chemistry. He received his Ph.D. in Chemical and Biomolecular Engineering from National University of Singapore in 2010. Dr. Gupta has been recipient of several fellowships and awards for his outstanding career in academic and research fields. Some of the fellowships and awards include DST Inspire Faculty Award 2013, IEI Young Engineer Award (2014-15), Young Scientist Award (2014-15), Young Faculty Research Fellowship 2018, and Fellowship of the Royal Society of Chemistry (FRSC) 2022.

Current Occupant

Prof. Shilpi Gupta from the Department of Electrical Engineering, IIT Kanpur, has research interests in electromagnetic simulations, nanofabrication, optical microscopy, spectral and time-resolved measurements, and theoretical modeling of nanophotonic devices. Prof. Gupta earned her B.Tech. in Engineering Physics from IIT Delhi, followed by an MS and PhD in Electrical Engineering from the University of Maryland, College Park. Her team's notable contributions include low-cost spectrometers, robust beam-shaping devices, crack detection in photonic crystals, quantum dot luminescence models, and cooling techniques for mechanical resonators.



Prof. Shilpi Gupta
(July 2022 - June 2025)

Current Occupant



Prof. Sudharshana N. P.
(March 2022 - Feb. 2025)

Prof. Sudharshana N. P. from the Department of Humanities and Social Sciences, IIT Kanpur, has research interests in applied cognitive semantics, english as a second language studies, and materials development. He earned his Ph.D. in English Language Education from the English and Foreign Languages (EFL) University, Hyderabad, India, in 2013.

Prof. Sudhanshu Shekhar Singh from the Department of Materials Science and Engineering, IIT Kanpur, has research interests in the mechanical behaviour of materials, different length scales, 3D/4D materials science, and laser-assisted processing of materials. Dr. Singh is the recipient of several prestigious awards, including membership in INYAS, the NASI Young Scientist Platinum Jubilee Award, the Young Metallurgist of the Year Award from the Ministry of Steel, and the IEI Young Engineer Award. He earned his B.Tech. in Metallurgical and Materials Engineering from IIT Kharagpur in 2008 and completed his Ph.D. at Arizona State University, USA, in 2015.

Current Occupant



Prof. Sudhanshu Shekhar Singh
(March 2022 - Feb 2025)

PROF. ARAKERE VASUDEV FACULTY RESEARCH FELLOWSHIP



Dr. D. S. Hur instituted the Prof. Arakere Vasudev Fellowship. He is the former Chairman and CEO of GS Caltex (South Korea). He received his Master's degree in Chemical Engineering from the American College in 1968 and completed his doctorate from the same institution in 1971. Dr. Hur joined GS Caltex in 1973 and played a pivotal role in driving the company to new heights. Under his leadership in the 1990s, GS Caltex began exploring alternative energy technologies, and in the early 2000s, it launched two subsidiaries focused on eco-friendly materials and systems.

With extensive experience in production, supply-demand management, and strategic planning, Dr. Hur played a critical role during the second oil crisis by leading GS Caltex to become the first Korean refinery to adopt toll processing and export operations using idle facilities. In recognition of his leadership, he was awarded the Manager of the Year Prize at the 2018 Management Grand Awards by the Korea Management Association.

Prof. Ketan Rajawat is a Professor in the Department of Electrical Engineering, IIT Kanpur, has research interests in signal processing, robotics, and communication networks, with a focus on distributed optimization and online learning. He received his B. Tech and M. Tech degrees in Electrical Engineering from IIT Kanpur in 2007, and his Ph.D. in Electrical and Computer Engineering from the University of Minnesota, Minneapolis, USA, in 2012. He is the recipient of the Qualcomm Faculty Award (2024), INSA Medal for Young Scientists (2018) and the INAE Young Engineer Award (2019).

Current Occupant



Prof. Ketan Rajawat
(March 2023 - March 2026)

RAJIV AND RITU BATRA NEW FACULTY FELLOWSHIP



Mr. Rajiv Batra (BT/EE/1982) instituted the Rajiv and Ritu Batra New Faculty Fellowship. Mr. Rajiv Batra is the Founder of Palo Alto Networks, where he was responsible for building and leading the engineering department from its inception. During his tenure, he held several key roles including Founder, Member of the Office of the CEO, and Senior Vice President of Engineering. Palo Alto Networks has since become the world's largest independent enterprise security company.

Before founding Palo Alto Networks, Mr. Batra served as Vice President of Engineering at Peribit Networks, a company known for developing industry-leading products in WAN optimization and acceleration. Peribit was acquired by Juniper Networks in July 2005. He was also the Founder and Vice President of Engineering at VitalSigns Networks, which was acquired by International Network Services in 1998.

Mr. Batra was honored with the Entrepreneurial Achievement Award by the University of Wisconsin–Madison in 2012. He holds an M.S. in Computer Sciences from the University of Wisconsin–Madison (1983). In recognition of his exceptional accomplishments, IIT Kanpur conferred upon Mr. Batra the Distinguished Alumnus Award in 2020.

Current Occupant

Prof. Adithya Vadapalli from the Department of Computer Science and Engineering, IIT Kanpur, has research interests in privacy-enhancing technologies and applied cryptography, with a focus on metadata protection, oblivious RAMs, secure multi-party computation, and secure machine learning.



Prof. Adithya Vadapalli
(Aug 2023 - August 2026)

PROF T R VISWANATHAN YOUNG FACULTY FELLOWSHIP IN TEACHING EXCELLENCE

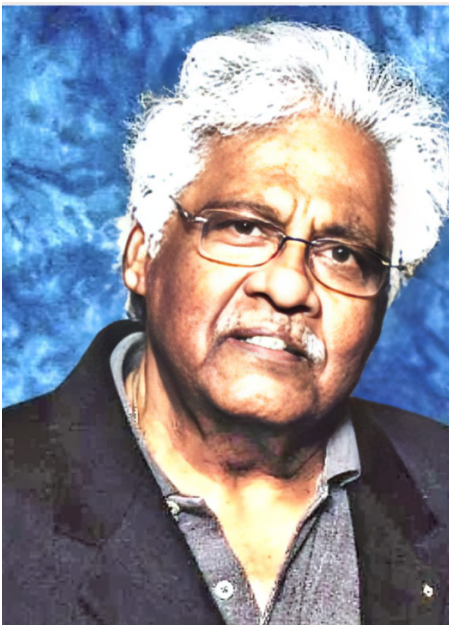

Instituted through generous donations by the IITK alumni community, this Fellowship honors **Prof. T. R. Viswanathan**, one of the founding faculty members of IIT Kanpur who joined in the 1960s during its formative years. He served as Professor of Electrical Engineering, Head of the Computer Centre, and Dean of R&D. He taught Electrical and Computer Engineering courses and supervised graduate research in Analog Integrated Circuit Design. Dr. Viswanathan spent 15 years in research, product design, manufacturing, and management in industry. He retired as Director of R&D at Texas Instruments and later became a Partner at Artiman Ventures. He earned a B.Sc. in Physics from the University of Madras in 1956, receiving the Jagirdar of Arni gold medal for academic excellence. He was also Research Professor Emeritus at the University of Texas at Austin and held the Silicon Laboratories Endowed Chair in Electrical Engineering for thirteen years.

The Fellowship recognizes outstanding young faculty under 40 who demonstrate excellence in teaching and are pioneering innovative pedagogical approaches.

Prof. Amit Verma from the Department of Electrical Engineering, IIT Kanpur, has research and teaching interests in the fabrication, characterization, and modeling of semiconductor devices, with a current focus on phase change materials and wide-bandgap semiconductors. He is a recipient of the Early Career Research Award from the Science and Engineering Research Board (SERB). Dr. Verma holds an Integrated M.Tech. in Engineering Physics from IIT-BHU (2010), a Ph.D. in Electrical Engineering from the University of Notre Dame (2015), and completed a postdoctoral fellowship at Cornell University.

Current Occupant



Prof. Amit Verma
(March 2023 - March 2026)

Current Occupant

Prof. S. K. Misra from the Professor at the Department of Biological Sciences & Bioengineering, IIT Kanpur, has research interests in the areas of developing materials and their optimized applications for “Personalized biomedical devices”, “Biosensors” “Nanomedicine” and “Gene therapy carriers”. He is also the recipient of the prestigious Ramalingaswami Fellowship (2019-2024) from the Department of Biotechnology, Govt. of India. He received his doctoral degree from Indian Institute of Science (IISc) Bangalore in 2013.



Prof. S. K. Misra
(March 2023 - March 2026)

RAJEEV AND JOYCE GAUTAM YOUNG FACULTY FELLOWSHIP



Dr. Rajeev Gautam (BT/CHE/1974) instituted the Rajeev and Joyce Gautam Young Faculty Fellowship. Dr. Gautam retired in 2021 as President & CEO of Honeywell Performance Materials and Technologies (PMT), concluding a distinguished 43-year career. Under his leadership, PMT became a \$10 billion global business offering advanced materials, process technologies, and automation solutions. He also served as President of Honeywell UOP, a leading provider of refining and petrochemical technologies, and as Vice President and Chief Technology Officer of both UOP and PMT.

Dr. Gautam began his career with Union Carbide in 1978 and joined UOP through a joint venture in 1988. He played a key role in the development and commercialization of catalytic and separation technologies widely used in the refining, petrochemical, and gas processing industries. He holds a PhD in Chemical Engineering from the University of Pennsylvania and an MBA from the University of Chicago. He is a recipient of the Distinguished Alumnus Award from IIT Kanpur (2020).

Current Occupant

Prof. Dipin S Pillai from the Department of Chemical Engineering, IIT Kanpur, has research interests in Stability Theory, Reduced-Order Modeling, Transport Phenomena, Electrohydrodynamics And Active Droplets. He earned his B.E. (Hons.) from BITS Pilani, Goa in 2010 and PhD from IIT Madras in 2016. His honors include the INAE Young Associate (2024), IIT Madras Best Research Award (2015), and the Dhirubhai Ambani Undergraduate Fellowship (2006).



Prof. Dipin S Pillai
(Dec 2024 - Dec 2027)

LIST OF FACULTY FELLOWSHIPS

S. No.	Name of the Fellowship	Name of the Donor
1	Cherian and Vignya Mathew Faculty Fellowship for AI	Mr. Cherian Mathew (BT/CSE/2008)
2	Class of 1986 Young Faculty Fellowship	Class of 1986
3	Batch of 1973 Faculty Fellowship	Batch of 1973
4	Class of 1979 Young Faculty Fellowship	Class of 1979
5	Batch of 1993 Faculty Fellowship	Batch of 1993
6	D. Shukla New Faculty Fellowship	Mr. Devendra K Shukla (BT/CE/1967)
7	Dr. Mahua Menan and Mr. Ranodeb Roy Young Faculty Fellowship	Mr. Ranodeb Roy ((BT/CSE/1990)
8	PK Kelkar Fellowship	Institute
9	PK Kelkar (1970 Batch) Fellowship	Class of 1970
10	PK Kelkar (Class of 1979 Research Fellowship for Outstanding Young Faculty)	Class of 1979
11	PK Kelkar (1982 Batch) Fellowship	Mr. Jagjeet Singh Bindra (BT/CHE/1969)
12	Pradeep Jotwani Young Faculty Fellowship	Mr. Pradeep Jotwani (BT/ME/1988)
13	Prof. Arakere Fellowship	Dr. D S Hur
14	Prof. R. N. Biswas Young Faculty Fellowship in Teaching Excellence	IITK Alumni
15	Prof. T. R. Viswanathan Young Faculty Fellowship in Teaching Excellence	IITK Alumni
16	Rajeev and Joyce Gautam Young Faculty Fellowship	Dr. Rajeev Gautam (BT/CHE/1974)
17	Rajiv and Ritu Batra New Faculty Fellowship	Shri Rajiv Batra (BT/EE/1982) & Mrs. Ritu Batra
18	Sangeeta and Rajeeva Lahri Young Faculty Fellowship	Dr. Rajeeva Lahri (MSc/PHY/1974) & Mrs. Sangeeta Lahri
19	Sir M Visvesaraya Research Fellowship	Ministry of Water Resources
20	WISE New Faculty Fellowship	Dr. Anjali Joshi (BT/EE/1981)
21	1984 Batch Fellowship	Class of 1984

CONVOCATION AWARDS

GOPAL DAS BHANDARI MEMORIAL DISTINGUISHED TEACHER AWARD



Prof. Purushottam Kar
(Dept. of Computer Science &
Engineering)

To honor an outstanding teacher chosen
by the graduating batch of undergraduate
students.

SUSHILA AND KANTILAL MEHTA AWARD

Prof. Mrinmay Biswas
(Dept. of Mathematics & Statistics)

For a faculty member of the department
of Mathematics who has motivated and
encouraged students to pursue pure
mathematics through his/her teaching
and research.



DISTINGUISHED LECTURE SERIES

This initiative brings renowned experts and thought leaders from diverse fields to engage with IIT Kanpur's students, faculty, and broader community. Supported by alumni and well-wishers, the lecture series enriches the institute's academic environment and fosters meaningful knowledge exchange. It serves as a catalyst for interdisciplinary dialogue, inspires new ideas, and strengthens the institute's commitment to academic excellence and global engagement.

PROF. E C SUBBARAO DISTINGUISHED LECTURE SERIES



Dr. Enrique J. Laverni spoke on “Exploring Mechanical Behavior of High-Entropy Alloys Across Temperature Extremes” On Feb 13th 2025. Prof. Enrique J. Lavernia, M. Katherine Banks Chair at Texas A&M University, is a renowned expert in Materials Science and Mechanical Engineering. A member of the National Academy of Engineering and the National Academy of Inventors, he holds a Ph.D. from MIT. His research focuses on nanostructured and multi-scale materials. His numerous honors include the TMS Bruce Chalmers Award (2024), Acta Materialia Gold Medal (2020), and Humboldt Research Award (2016).

Dr. Eleswarapu Chinna Subbarao earned his BSc in Glass Technology from Banaras Hindu University in 1949, and BS (1952) and MS (1954) degrees in Ceramic Engineering from the University of Washington, Seattle. He completed his PhD in Ceramic Technology at Pennsylvania State University in 1957, with pioneering research on domain effects in ferroelectric ceramic barium titanate.

Dr. Subbarao began his professional career at Westinghouse Research Laboratories, Pittsburgh, where he worked from 1956 to 1963. He joined IIT Kanpur in 1963 as the founding Head of the Department of Metallurgical Engineering and later became the first Dean of Faculty. He played a key role in recruiting world-class faculty and advancing the institute's academic foundations. He also initiated the first conference on Materials Science Education in India in 1966 and established an interdisciplinary postgraduate programme in Materials Science at IIT Kanpur. Later, he served as the Founder-Director of the Tata Research Development and Design Centre, Tata Consultancy Services, Pune.

In recognition of his contributions, the Prof. E. C. Subbarao Distinguished Lecture Series was instituted by Mr. Ram Kumar in the Department of Materials and Metallurgical Sciences.



SHRI RAKESH PANDEY DISTINGUISHED LECTURE SERIES IN MECHANICAL ENGINEERING DEPARTMENT



Dr. Hanif Qureshi, CEO, National Automotive Board, spoke on *“Towards sustainable mobility: navigating the future of transportation in India”* on April 13, 2024. Dr. Qureshi, IPS is a senior Indian Police Service officer of the Haryana cadre, currently serving as Additional Secretary in the Ministry of Heavy Industries, Government of India. With a distinguished academic background—B.Tech, M.Tech, MBA (OB), and Ph.D. in Criminal Justice from the University of Cincinnati—he blends technical, managerial, and policy expertise. A TEDx speaker, published scholar with 38+ peer-reviewed articles, and experienced educator (including at IIT Kanpur), he brings together law enforcement, public administration, policy, and academia in a rare, impactful mix.

Dr. R.S. Pandey Distinguished Lecture Series is supported by Mr. Rakesh Pandey (BT/ME/1978). Under this lecture series, the Department of Mechanical Engineering organizes lectures by distinguished people. Mr. Rakesh Pandey was the Chief Financial officer of the IITK Foundation. He joined the Foundation in 2006 and served as its Secretary from 2006-2009, he was elected as the President of IITK Alumni Association.

Dr. Pandey had a long tenure at Bose Corporation spanning research, innovation, product development, business start-up, sales and marketing. He launched and ran Bose’s subsidiary in India in 1995, started Bose Technology Center in India in 2003, and created the Center for University and Industry Research in 2008.

SAMSONOV MEMORIAL INTERNATIONAL LECTURE SERIES

Mr. Hem Takiar, Corporate Vice President, Micron Technology spoke on ‘Empowering India’s Packaging Academic R&D Through Global Industry & Supply Chain Partnerships’ on March 21, 2025. Mr. Takiar is a distinguished leader in the semiconductor industry with over four decades of experience in semiconductor packaging, covering everything from design to high-volume manufacturing. Mr. Takiar holds a Master’s degree in Materials Science from the University of Illinois at Urbana-Champaign and a Bachelor’s degree in Metallurgical Engineering from the Indian Institute of Technology Kanpur.

Prof. Gopal Shankar Upadhyaya joined the department of Metallurgical Engineering (now Materials Science and Engineering) at the Indian Institute of Technology Kanpur as a Professor in 1976. Prior to that he was Associate Professor at the University of Roorkee (now IIT Roorkee) from 1964-1975. He was awarded a doctorate degree from the Kiev Institute of Technology, Ukraine in 1969 under the guidance of internationally renowned Materials Scientist Professor G.V. Samsonov. Professor Upadhyaya’s publications list exceeds 300 papers and 16 authored/edited books. **Prof. Upadhyaya instituted the Samsonov Memorial International Lecture Series** in memory of his PhD advisor, Prof. G.V. Samsonov.



DR. RAJYASHREE KHUSHU LAHIRI MEMORIAL LECTURE SERIES



Ms. Laila Tyabji spoke on *“Craft in the Age of Technology”* on 28th January, 2025. Ms. Tyabji is Chairperson and founder member of Dastkar, an NGO working with crafts and craftspeople all over India. Her work with artisans over the last 40 years includes the chikan workers of SEWA Lucknow, tribals in Karnataka, and the aari, mirror-work and kantha craftswomen in Kashmir, Kutch and Bengal. Many of her projects involve creating new employment avenues through craft for pastoral and marginalised rural communities. She was awarded the Padma Shri for her work in craft and development in 2012, and is also the recipient of the Aid To Artisans Preservation of Craft Award New York 2003 and the NIFT Lifetime Achievement Award among others.

Late Dr. Khushu Lahiri, an esteemed alumna of IIT Kanpur, earned her PhD in English under the guidance of Professor R. K. Gupta. Her distinguished academic journey was marked by several prestigious accolades, including the Fulbright Doctoral Fellowship at the University of Minnesota, the UGC Postdoctoral Fellowship, an Associateship at the Indian Institute of Advanced Study (IIAS), Shimla, and a British Council Grant at Oxford University.

She began her academic career at St. Xavier’s College, Ahmedabad, and joined the Department of Humanities and Social Sciences, IIT Roorkee in 2006. In 2011, she moved to IIT Ropar, where she served as Head of the Department of Humanities and Social Sciences. **Mr. Somdeb Lahri instituted Dr. Rajyashree Khushu Lahiri Memorial Lecture Series** that is conducted by the Department of Humanities and Social Sciences.



PROF. ARBINDO NATH BOSE BIOENTERPRENURESHIP DISTINGUISHED LECTURE SERIES



Dr. Anil Koul spoke on *“Discovery of Bedaquiline and Its Impact on the Global TB Landscape”* on February 21, 2025. Dr. Koul is the Vice President of Global Public Health at Johnson & Johnson and also serves as a Board Member and Professor of Translational Discovery at LSHTM. With over 25 years of experience in pharmaceutical drug discovery and early clinical development, he has successfully advanced projects from initial drug discovery stages to human studies. His PhD and early training were at the Max Planck Institute in Germany in the lab of ‘Lasker Award’ winner Prof Axel Ullrich. At Johnson & Johnson, Dr. Koul has led innovation-driven, cost-effective R&D programs and previously served on the Board of Janssen Pharmaceuticals, Belgium. With expertise across infectious diseases, neuroscience, and oncology, he has worked on small molecules, biologics, microbiome, and AI platforms.

This lecture series was instituted by Dr. Arindam Nath Bose (BT/CHE/1975) in memory of his late father, Shri Arabindo Nath Bose, who established the department of Food Technology at Jadavpur University in Calcutta in early 1950s. Dr. Arindam Nath Bose holds a Master’s degree from the University of Michigan and a PhD in Chemical Engineering from Purdue University. With over 30 years of experience in the biopharmaceutical industry, he has contributed significantly to bioprocess development, clinical supply manufacturing, and biotechnology strategy. As Vice President of External Affairs and Biosimilar Strategy at Pfizer’s Biotherapeutics Pharmaceutical Sciences division, he played a key role in shaping biosimilar strategy, regulatory advocacy, and global product development initiatives.



DEVENDRA SHUKLA 1967 LECTURE SERIES



Ms. Anumita Roy Chowdhury, Executive Director at the Centre for Science and Environment, New Delhi spoke on *“Driving Change for Clean Air and Climate”* Interlinking Solutions for Scalable Transformation’ on 19th March 2025.



Dr. Devendra Shukla (BT/CE/1967) is the founder of Innovative Technical Solutions Inc. (ITSI), one of the leading environmental and infrastructure firms in the northwestern United States. Known for its award-winning work, ITSI has extensive experience in collaborating with federal government departments and international agencies. The company is now a wholly owned subsidiary of the Gilbane Building Company. In recognition of his exceptional entrepreneurial achievements and leadership, Dr. Shukla was conferred the Distinguished Alumnus Award by IIT Kanpur in 2009. **Dr. Shukla instituted the Devendra Shukla Distinguished Lecture Series** for the Department of Civil Engineering.

PROF. U. B. TEWARI DISTINGUISHED LECTURE SERIES IN MATHEMATICS

Prof. Pertti Mattila spoke on “*Applications of the Fourier transform to Hausdorff dimension*” from November 7-11, 2024. He is a Finnish mathematician and a leading figure in geometric measure theory and fractal geometry. His books “*Geometry of Sets and Measures in Euclidean Spaces: Fractals and Rectifiability*” and “*Fourier Analysis and Hausdorff Dimension*” are widely cited.

Prof. Pertti Mattila obtained his Ph.D in Mathematics from the University of Helsinki in 1973. He has received several awards and honors for his work, including the Magnus Ehrnrooth Foundation Prize (2000), given by Finnish Society of Science and Letters.

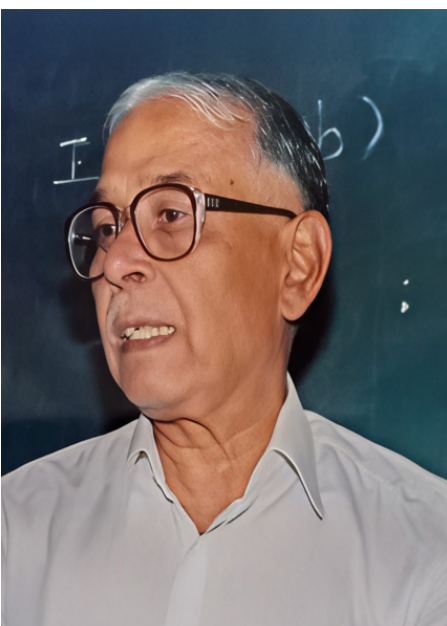

Prof. U. B. Tewari lecture series honors the legacy of Prof. U.B. Tewari (popularly known as UBT), a distinguished mathematician who played a pivotal role in shaping the Department of Mathematics at IIT Kanpur, particularly in the area of Analysis. After completing his bachelor's and master's degrees from Lucknow University, he joined IIT Kanpur in 1964 as a PhD student and later pursued his doctorate at the University of California, Berkeley under Prof. Henry Helson, a leading expert in Harmonic Analysis, earning his PhD in 1969. He returned to IIT Kanpur in 1970 as a faculty member and rose to the position of Professor. Prof. Tewari was known for his inspiring and rigorous teaching, which helped generations of students grasp complex mathematical concepts. He established the Harmonic Analysis school at IITK and fostered collaboration with leading mathematicians across institutes. His contributions earned him several prestigious honors, including the Shanti Swarup Bhatnagar Prize, Meghnad Saha Award, and Fellowship of the National Academy of Sciences, India. **Prof. U. B. Tewari Distinguished Lecture Series in Mathematics. was instituted by the family, friends, and former students of Prof. U. B. Tewari.**

DISTINGUISHED LECTURE SERIES IN DEPARTMENT OF PHYSICS



Prof. Diptiman Sen, Professor at the Indian Institute of Science Bangalore, spoke on 'Kinetically Constrained Models Showing Hilbert Space Fragmentation' on February 20, 2025. His work focuses on a complex area of quantum physics called Hilbert Space Fragmentation.

This distinguished lecture series is established in the department of physics by the well-wishers and alumni of the IIT Kanpur.

PROF. RAKESH POPLI AND MRS. RAMA POPLI DISTINGUISHED LECTURE SERIES

Prof. Manish Jain spoke on "*Common Man Science*" on November 11, 2024. Prof. Jain is the Founder and Head of the Center for Creative Learning at IIT Gandhinagar involved in outreach activities among all rural and urban schools. He is deeply involved in promoting hands-on, experiential learning methods to make science more engaging and accessible. He completed his B.Tech in Electrical and Electronics Engineering from IIT Kanpur.



Ms. Shivaranjani Popli Verma and Dr. Abhimanyu Popli, established this lecture series under their parents' names.

Prof. Rakesh Kumar Popli was a faculty member in the Department of Physics at IIT Kanpur from 1981-1983. He left his job at IIT Kanpur to work for the education and upliftment of the tribal population of India. He was instrumental in

establishing Ekal Vidyalaya, a non-profit organization that aims to educate children in rural and remote areas of India. Mrs. Rama Popli, wife of Prof. Rakesh Popli is a specialist in elementary education for children with more than 40 years of experience in field research, action research and rural social development. She founded Kislaya Vidya Mandir, which later became an incubator for the creation of curricula for Ekal Vidyalaya. Through her non-profit organization Panini Foundation, she continues to contribute in the field of elementary education for children.

PROF. AMIT DUTTA MEMORIAL DISTINGUISHED LECTURE SERIES



Prof. Diptiman Sen spoke on 'Some Analytical Techniques For Studying Quantum Many-Body Systems' on February 17-19, 2025. His research interests include condensed matter systems in low dimensions, mesoscopic systems, and various aspects of quantum field theory. Prof. Sen received his PhD in Physics from Princeton University in 1984.

Prof. Amit Dutta was a condensed matter physicist working in the Department of Physics at IIT Kanpur in various aspects of phase transitions, non-equilibrium systems, quantum information and quantum critical phenomena. He completed his B.Sc. (Honors) and M.Sc in Physics, from the University of Calcutta and his PhD from Jadavpur University, Kolkata. He joined the institute in 2003 after completing his postdoctoral tenure at Max-Planck Institute for Complex-Systems, Dresden (Germany). While in Kanpur, he established a vibrant quantum condensed matter research group, from where his students have nucleated their own research groups across the world. His contributions, particularly to the physics of non-equilibrium quantum condensed systems, is highly regarded in the community. He was also a fellow of the Indian Academy of Sciences. He tragically passed away in 2022. This lecture series, in his memory, has been constituted by support from the Dutta family.



LIST OF DISTINGUISHED LECTURE SERIES

S. No.	Name of Distinguished Lecture Series	Name of the Donor	Department
1	Annual Exhibition Cum Lecture Series	Ram Rajendra Malhotra Education Society	Design
2	Dr. Arun Bansil Distinguished Lecture Series	Prof. Arun Bansil	Open to all Departments
3	Dr. Rajendra Rathore Seminar Series	Rajani Nigam Family and Friends	Chemistry
4	Dr. Rajya Shree Khushu Lahri Memorial DLS	Mr. Somdeb Lahari	Humanities and Social Sciences
5	Devendra Shukla 1967 Lecture Series	Mr. Devendra Shukla (BT/CE/1967)	Civil Engineering
6	Distinguished lecture Series in Department Chemistry	Sixth National Symposium	Chemistry
7	Distinguished Lecture Series in Department of Physics	Batch Mates	Physics
8	IIT Kanpur Swastibhavatu Lecture Series Supported by Rawat Family Trust	Dr. Shishpal S. Rawat and Mrs. Hemangi D. Rawat (BT/EE/1979)	Kotak School of Sustainability
9	J. Mohanty Distinguished Lecture Series in Physics	Family and friends	Physics
10	Jeet Singh Bindra Distinguished Lecture Series	Mr. Jagjeet Singh Bindra (BT/CHE/1969)	Chemical Engineering
11	K. R. Sharma Distinguished Lecture Series	Dr. K. Sri Nageswari	Electrical Engineering
12	Petro Tel Distinguished Lecture Series	Mr. Anil Chopra (BT/CHE/1973)	Chemical Engineering
13	P. D. Murty Memorial Distinguished lecture Series	Mr. Ram Mohan (BT/AE/1970) and Mrs. Shiela Mohan	Department of Management Sciences
14	Prabha and Ramadhar Singh Distinguished Lecture Series	Mr. Manish Singh	Department of Humanities & Social Sciences
15	Prof. Amit Dutta Memorial Distinguished Lecture Series	Mr. Shantanu Dutta, Ms. Doll Guha Dutta	Physics
16	Prof. Arbindo Nath Bose Bioenterprenuership Distinguished Lecture Series	Dr. Arindam Bose (BT/CHE/1975)	Biological Sciences and Bioengineering

17	Prof. C N R Rao Distinguished Lecture Series	Prof. C N R Rao	Open to all departments
18	Prof. C V Sheshadri Memorial Distinguished Lecture Series	Student, Family Members and Friends	Chemical Engineering
19	Prof. E C Subbaroa Distinguished Lecture Series	Mr. Ram Kumar	Materials & Metallurgical Engineering
20	Professor N. Sathyamurthy Endowment Lecture Series	Friends and Family	Chemistry
21	Prof. Rakesh Popli and Mrs. Rama Popli Distinguished lecture Series	Dr. Abhimanyu Popli and Ms. Shivaranjani Popli	Physics
22	Prof. Ramamoorthy Distinguished Lecture Series	Dr. Shashi M Kuppa (BT/CE/1985)	Electrical Engineering
23	Prof. U. B. Tewari Distinguished Lecture Series in Mathematics	Family and friends	Mathematics & Statistics
24	Ramchandra Rao Dasari Lecture Series	Dr. Satish Dasari	Center of Lasers & Phonetics
25	Ramanujam Memorial Lecture Series	Secretary Systems Society of India	Chemical Engineering
26	Ranjan Memorial Lecture Series	Friends	Department of Management Science
27	Samsonov Memorial International Lecture Series	Prof. G S Upadhyaya	Materials Science & Engineering
28	Shri Rakesh Pandey Distinguished Lecture Series in Mechanical Engineering Department	Mr. Rakesh Pandey (BT/ME/1978)	Mechanical Engineering
29	Prof. Vinod K Singh Distinguished Lecture Series	Dept., Family, Friends & well wishers	Chemistry

OUTREACH ACTIVITIES

The DoRA Office at IIT Kanpur organizes year-round outreach activities—such as reunions, IIT Karvaan, and alumni networking events—to strengthen ties with alumni and inspire fundraising initiatives. These efforts foster lasting connections while supporting the Institute’s growth and development.

CLASS OF 1964 REUNION

The 60th year reunion (Diamond Jubilee Reunion) of Class of 1964 was held from November 8–10, 2024, with 44 alumni in attendance. It was a heartfelt celebration of six decades of friendship and shared memories. The event featured engaging presentations, updates on IIT Kanpur's initiatives, and a gala dinner filled with laughter and camaraderie. Alumni honored their achievements and remembered those who are no longer with us, rekindling pride in their remarkable journeys.



CLASS OF 1999 REUNION

The Class of 1999 returned to campus from December 27–29, 2024, to celebrate their 25th year reunion—rekindling old friendships and reliving cherished memories. With 187 alumni in attendance, the event was a joyful celebration of enduring bonds. Alumni revisited familiar corners of the campus, interacted with students, and paid tribute to late classmates. A highlight of the reunion was the collective pledge of Rs.13.6 crore to support IIT Kanpur's future initiatives, marking a proud and impactful milestone.



CLASS OF 1989 REUNION



From January 2–5, 2025, the IITK campus came alive with nostalgia as the Class of 1989 celebrated their 35th year reunion. 70 alumni returned to relive memories, share laughter, and reconnect with lifelong friends. From hostel corridors to lecture halls, familiar spaces sparked heartfelt recollections and renewed bonds. The reunion was a moving tribute to their shared journey and the lasting spirit of the IITK community; leaving behind not just fond memories, but a renewed commitment to stay connected and support their alma mater.



CLASS OF 2014 REUNION

The IIT Kanpur Class of 2014 celebrated their 10th year reunion on campus from January 10–12, 2025, with 50 alumni in attendance. Marking a decade of friendship and growth, the event included campus and hall visits, department interactions, and engaging sessions with students. Alumni reconnected with peers and professors, reflected on their journeys, and strengthened their bond with the alma mater in a warm, memorable gathering.



IIT KANPUR
Indian Institute of Technology Kanpur



CELEBRATING
10 YEARS
REUNION

WELCOME BACK
CLASS OF 2014



CLASS OF 1995 REUNION

The Class of 1995 returned to their beloved alma mater to celebrate their 30th year reunion held from 24th -27th January 2025, with hearts full of nostalgia and eyes gleaming with old memories. The campus came alive with familiar laughter, spirited cricket matches, and warm cups of chai shared under winter skies. From revisiting Bithoor to engaging with the vibrant startup ecosystem at SIIC, the batch relived not just the lanes of IITK but also the spirit that shaped them. With every hug, every shared smile, and every silent walk across the campus, they didn't just revisit IIT Kanpur; they reclaimed a part of themselves.



CLASS OF 1975 REUNION

IIT Kanpur had the privilege of welcoming the Class of 1975 back to the campus for their golden jubilee reunion, held from 27th February to 2nd March 2025, with 119 alumni in attendance. The gathering was filled with nostalgia, renewed friendships, and reflections on the Institute's remarkable journey. From campus and department visits to discussions on their Batch Legacy Project, alumni celebrated old memories while looking ahead to IITK's future. With student interactions, a picnic lunch, and a gala dinner, the event was a perfect blend of reflection and celebration.



CLASS OF 1970 REUNION

The Class of 1970 returned to IIT Kanpur for a heart-warming 55th year reunion held from 24th to 26th February 2025, joined by eighteen members of the batch. The three-day event featured a campus tour, interactive sessions with the Director and Dean of Resources & Alumni, and discussions on IITK's future vision. Alumni also took part in a Pickleball workshop, visited Guru Nanak Modern School and ISKCON Temple, and came together for a memorable gala dinner—celebrating lasting bonds and shared memories.



CLASS OF 1985 REUNION

The Class of 1985 celebrated their 40th year reunion at IIT Kanpur from 7th to 10th February 2025, with ninety alumni coming together for a memorable occasion. From hostel corridors to lecture halls, every corner of the campus brought back stories of friendship, ambition, and unforgettable student life. The reunion beautifully blended nostalgia and reflection, as batchmates shared their journeys since graduation—their achievements, challenges, and the lasting impact of their IITK experience. The joy of reconnecting was matched by a renewed commitment to give back, further strengthening their bond with the Institute and future generations. As laughter echoed and memories were re-lived, one thing was clear: time may pass, but the IITK bond endures.



CLASS OF 1980 REUNION

The Class of 1980 returned to IIT Kanpur for their 45th year reunion held on 2nd to 4th March 2025—an inspiring journey back to their roots. Fifty-four alumni reunited to reconnect with friends, explore campus developments, and celebrate their shared legacy. The event included interactive sessions, an art exhibition, a nostalgic campus tour, and a Holi-themed dinner, perfectly balancing reflection and celebration. A special plantation ceremony honoring departed batchmates added a heartfelt touch.



CLASS OF 1965 REUNION



The first-ever batch of IIT Kanpur, the Class of 1965, returned to campus for their historic 60th year reunion held from 6th to 9th March 2025, with 13 alumni attending. Walking through familiar corridors, they relived memories of their formative years—friendships, academic challenges, and the foundation they built for future generations. The reunion was filled with nostalgia, warmth, and inspiring reflections. A special felicitation honoured their contributions, while an interactive session with students bridged six decades of experience and innovation. As part of their legacy, the batch pledged to **establish the Pioneering Research & Innovation Award** at the institute, continuing their spirit of giving back to their alma mater.



IITKARVAAN

SINGAPORE

The IITKarvaan held its very first event of the year 2024-25 in Singapore on 11th May 2024, bringing together over eighty esteemed alumni along with their spouses. The event provided a wonderful opportunity to reconnect with the IIT Kanpur community abroad, share recent developments at the Institute, and explore future collaboration possibilities.



UNITED STATES OF AMERICA (USA)

USA IITKarvaan led by Prof. Manindra Agrawal, Director of IIT Kanpur, a delegation visited five major cities including New York, Washington DC, Chicago, Seattle, and the Bay Area. The purpose of the visit was to strengthen ties with IIT Kanpur alumni, expand the institute's network, build new connections, and explore potential collaborations to support its growth and development.

NEW YORK

The journey started in New York on 6th October 2024, with over 150 alumni attending an engaging event that celebrated distinguished alumni and explored the IIT Kanpur Foundation's role in global collaboration.



WASHINGTON, D.C.

After New York, IITKarvaan moved to Washington D.C on 11th October 2024. After an incredible start in New York, the energy continued to soar as we reconnected, reminisced, and strengthened bonds with our alumni in the capital city.



CHICAGO

Chicago marked the third stop on our IITKarvaan tour in the USA. The Karvaan event was held on 13th October 2024, where the Honorable Consulate General, Chicago, Mr. Somnath Ghosh delivered the keynote address. After amazing events in New York and Washington D.C., this event was filled with energy, laughter, and unforgettable moments. The Windy City kept the momentum going as we reconnected and celebrated with our alumni.



SEATTLE

Seattle marked the fourth stop on our IITKarvaan tour in the USA, and the energy was unmatched. Event was held on 16th Oct 2024, and the evening was filled with lively conversations, nostalgic reflections, and a sense of camaraderie that truly brought our alumni community closer.



BAY AREA

Last but not least, the Bay area edition of IITKarvaan was held on 19th October 2024, with a focus on deepening ties with alumni in the startup ecosystem and building innovation bridges between Silicon Valley and IITK. A Fireside Chat with Mr. Dheeraj Pandey - Co-Founder & CEO of DevRev was also the center of attraction.



IITKARVAAN INDIA TOUR

The IITKarvaan India tour was successfully conducted in December 2024, covering three major cities—Mumbai (13th Dec), Bengaluru (14th Dec), and Delhi (15th Dec). These alumni gatherings witnessed an enthusiastic participation of over 500 alumni, including prominent leaders from industry, government, and academia. Each event served as a vibrant platform to share institute updates, foster networking, and promote deeper engagement through mentorship, fundraising initiatives, and collaborative opportunities.

MUMBAI

IITKarvaan reached the City of Dreams- Mumbai, bringing together our vibrant alumni community for a night of reconnecting, reminiscing, and reigniting the IIT Kanpur spirit. Mr. Shashidhar Sinha (BT/CE/1979), CEO of IPG Mediabrands India delivered an inspiring powerful Keynote Address.



BENGALURU

The Silicon Valley of India came alive as IITKarvaan brought alumni together for an evening that celebrated camaraderie and everlasting connections. Mr. Amit Kumar Agarwal (BT/CE/2000), Co-Founder & CEO of NoBroker delivered an inspiring Keynote address that set the tone for an engaging and impactful evening.



DELHI

Delhi marked a fitting finale to the IITKarvaan journey, bringing together our vibrant alumni community for an evening of connection and celebration. The event honored our shared roots, while conversations focused on collaboration for IIT Kanpur's future growth.



AUSTRALIA

The Karvaan chapter in Australia took place in Melbourne on 15th March 2025. It was IIT Karvaan's second edition in the region. With an enthusiastic turnout of over 30 alumni, the event offered a perfect blend of nostalgia, networking, and vision sharing. Prof. Amey Karkare and Mr. Kapil Kaul represented the institute and the Development Foundation, respectively. The event emphasized branding IIT Kanpur internationally and discussed building a local alumni chapter for deeper engagement.



DISTINGUISHED ALUMNI MEET (DAM)

IIT Kanpur successfully hosted two editions of the Distinguished Alumni Meet (DAM)—one in Goa, India, with 18 Distinguished Alumnus Awardees (DAAs) and another in New York, USA, with 24 DAAs in attendance. These events served as high-impact platforms to honour our most accomplished alumni while reinforcing their vital connection to the institute.

Over the decades, IIT Kanpur has produced visionaries and changemakers who have shaped industries, research, and governance worldwide. DAM is our tribute to this legacy. It offers a stage for celebrating excellence, encouraging mentorship, and strengthening alumni-institute ties across borders. The meet focused on four key pillars: Community Building, by fostering a sense of belonging and shared purpose; Stewardship, by involving alumni in the institute's future direction; Collaboration for Social Impact, enabling partnerships on societal projects; and Legacy of Excellence, by showcasing alumni achievements that continue to inspire generations of students and faculty.

GOA

IIT Kanpur hosted its first-ever Distinguished Alumni Meet (DAM), 2024 in the vibrant setting of Goa, marking a milestone in alumni engagement. With the presence of 18 Distinguished Alumnus Awardees, the event became a powerful confluence of legacy, vision, and leadership. The meet featured deep and future-forward discussions on IIT Kanpur's evolving role as a global hub for education, research, and innovation. Our esteemed alumni—Mr. Mahesh Gupta, Dr. BVR Mohan Reddy, Dr. Ajay Kumar, Mr. Rakesh Bhargava, Mr. Hemant Jalan, Mr. Pradeep Bhargava, Mr. Alope Bajpai, Mr. Rajiv Swarup, Mr. Deepak Garg, Mr. Lalit Jalan, Mr. Rakesh Sharma and Mr. Naveen Tewari shared invaluable insights, helping shape a strategic roadmap for the institute's future.



NEW YORK

The second Distinguished Alumni Meet (DAM) held in New York in October 2024 was a resounding success, bringing together 24 Distinguished Alumnus Awardees for a powerful exchange of ideas, insights, and aspirations. Held at the IBM headquarters, the event was graciously hosted by Mr. Arvind Krishna and the IBM team, whose warm hospitality added immense value to the occasion.

The meet focused on advancing IIT Kanpur's global standing in education, research, and innovation. Our esteemed alumni offered critical insights and reaffirmed their strong commitment to the institute's growth and global outreach. From strategic discussions to future-forward collaboration, the event laid the groundwork for impactful alumni engagement and long-term institutional excellence.



ALMAKONNECT

AlmaKconnect is an innovative platform designed to bridge the gap between alumni and current students of IIT Kanpur. Through regular virtual or in-person interactions, AlmaKconnect aims to create a thriving community where knowledge, experience, and valuable connections are shared, ultimately enriching the academic and professional journeys of our students. At AlmaKconnect, we envision a dynamic and supportive ecosystem where alumni and students engage in meaningful interactions. Our platform is built on the principles of community, continuous learning, and mutual growth. By leveraging the vast experiences and insights of our esteemed alumni, we aim to inspire and guide students as they navigate the complexities of their academic and professional paths.



Mr. Rajeev Swaroop
(BT/EE/1973)



Mr. Ishendra Agarwal
(BT-MT/EE/2017)



Mr. Mohit Agarwal
(BT/CE/2011)

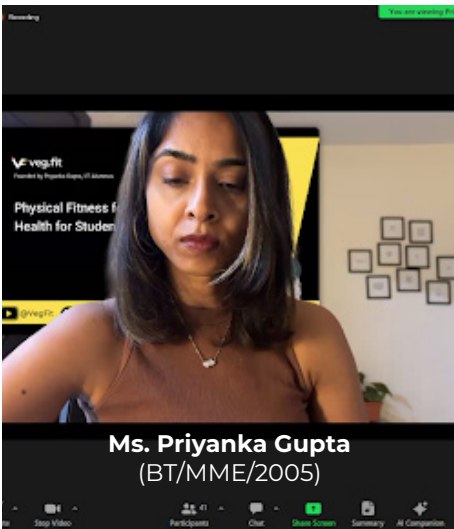

Ms. Priyanka Gupta
(BT/MME/2005)



Mr. Hari Padmanabhan
(BT/CE/1975)



Mr. Pawan Kadyan
(BT/EE/2008)
&
Mr. Aditya Srivastava
(BT-MT/EE/2019)



Mr. Gautam Khanna
(BT/ME/1988)

IITKONVERGE

IITKonverge is a strategic initiative aimed at building a lasting connection between donors and beneficiaries. It serves as a platform for continuous engagement, transparency, and collaboration showcasing the real impact of donor support through stories, events, and feedback-driven interactions.

It not only strengthens relationships but also highlights the positive change driven by alumni and well-wishers' contributions to IITK.

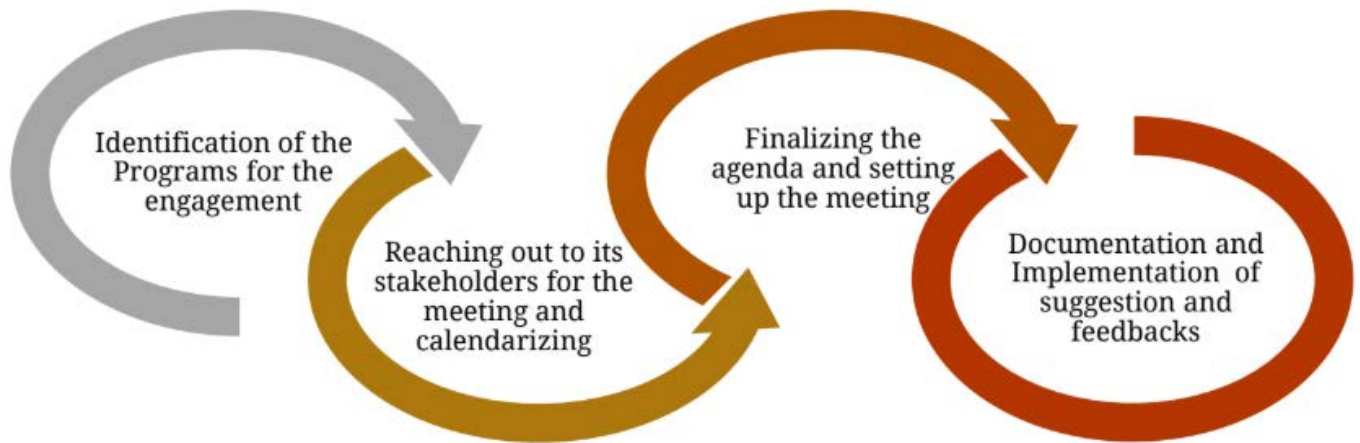

Program Name: **Batch of 1965 Scholarship**

Donor: **1965 Batch Initiatives**

Recipients: **Prapti Himanshu Dagli, Gokavarapu V V S S Manikanta, Yashaswi Raj**



Program Name: **Shanti and Ramkishore Sahai Saxena Memorial Scholarship**

Donor: **Mr. Ashok Saxena**

Recipient: **Rohan Gauranga Potukuchi**



Program Name: **Shanti Devi and Onkar Nath Maewal Memorial Scholarship**

Donor: **Mr. Akhilesh Maewal**

Recipient: **Apoorva Gupta**



Program Name: **Kashinath Jagdish Prashad Shakuntala Mittal Memorial Scholarship**

Donor: **Mr. Pradeep Mittal**

Recipients: **Anshu Yadav, Garima, Sapna, Thallapally Meghana**



Program Name: **Rooma & Ajay Dubey Health Care Innovation and Ideation Program (HII Program)**

Donor: **Mr. Ajay Dubey**

Recipients: **Rounak, Harsh Arora, Akshat Chouksey, Saksham**

PROJECT INITIATIVES

IIT Kanpur continues to advance education, research, and innovation through a range of impactful projects supported by alumni, industry partners, and well-wishers. These initiatives strengthen institutional infrastructure, enrich learning experiences, and reflect the collective commitment to nurturing excellence and contributing to societal progress.

CELL FOR DIFFERENTLY ABLED PERSONS (CDAP)



Instituted through the generous donations from Mr. Ranodeb Roy (BT/CSE/1990), the Ranodeb Roy Student Disability Program (RRSDP) aims to enhance the learning experience for students with disabilities at IIT Kanpur by facilitating access to assistive technologies, software, and devices. Strengthening this commitment, the Brisk Electronic Pvt Ltd (BEPL) project, supported through an endowment fund by BEPL in 2024 and led by the DORA office, further expands the availability and utilization of such resources on campus. The donated funds are also used to provide assistant services and initiate transport facilities for differently-abled students, reinforcing the institute's vision of an inclusive and supportive academic environment.

A postgraduate (M.Sc) student who earlier relied on a manual wheelchair and caretaker support now navigates the campus independently with an electric wheelchair provided under CDAP. This intervention has significantly improved her mobility, comfort, and participation in academic life.



A KIBO assistive reading device has been installed at the library to support visually impaired students. KIBO enables users to instantly convert printed or digital text into audio, allowing them to independently access books, documents, and academic materials available in the library.

SHIVANI CENTER FOR NURTURE AND REINTEGRATION OF HINDI AND OTHER INDIAN LANGUAGES



Shivani Centre was established through the generous support of the Micky and Vinita Pant Charitable Foundation. The Foundation was instituted by Mr. Muktesh Pant, a Distinguished Alumnus of IIT Kanpur (BT/CHE/1976).

Mr. Pant has held prominent leadership roles across global food and consumer goods companies in China, the United States, and India. He served as the CEO of Yum China—China's largest restaurant company with over 15,000 outlets—and successfully led its public listing on the New York Stock Exchange in 2016. Prior to that, he was the Global CEO of KFC in the US and has also held senior positions at Unilever, PepsiCo, and Reebok.

The Centre was established in memory of his late mother, Padma Shri awardee and celebrated Hindi writer Smt. Gaura Pant, popularly

known by her pen name 'Shivani'. It aims to promote and reintegrate Hindi and other Indian languages into mainstream academia. The initiative focuses on making educational content available in regional languages to bridge language barriers, enhance employment opportunities, and support students in their academic and personal development.

EVENT HIGHLIGHTS

GATHA MAHOTSAV

Gatha Mahotsav 2024, held on July 21 at IIT Kanpur, marked its fifth edition with a vibrant celebration of literature, music, and culture. Organized by the Shivani Centre, Hindi Cell, and Gatha platform, the event featured the book launch of **Ek Syah Firdaus**, talks on UP tourism by Prof. M.K. Pandey, sessions with young authors, a tribute to Madan Mohan, a performance by Jyoti Mook Badhir Vidyalaya's children, and a Kavi Sammela. Highlights included actor Rajendra Gupta's reflections on his artistic journey and Cannes insights by Mr. Ashok Pathak. Co-founder Mr. Amit Tiwari commended the festival's role in preserving India's cultural heritage.



DASTAN-E-MEHEK

IIT Kanpur hosted **Dastan-e-Mehek** on August 1, 2024, a storytelling event organized by the Shivani Centre, Hindi Sahitya Sabha, and Rajbhasha Prakoshth, aimed at nurturing love for Hindi literature among the youth. The event featured acclaimed storyteller and writer Ms. Mehak Mirza Prabhu as the chief guest, known for her evocative narratives and distinctive storytelling style. Founder of the storytelling school **Jhumritalaiya**, Ms. Prabhu engaged the audience with stories such as **Jhumka**, **Parle-G**, and **Keri Ka Achar**, encouraging reflection and personal interpretation.



AKSHAR

Day 1 Akshar 2024, held from October 17–19 2024 at IIT Kanpur, opened with a session on the literary legacy of Shivani ji, followed by compelling dramatizations of her stories **Siddhi Mai** and **Sati** by the Katharang group. The festival celebrated young talent through **Bachchon ka Kona** and **Aaj ke Ubharte Sitare**. A captivating **Dastangoi** performance on **Sahir Ludhianvi** by Himanshu Bajpai and Pragya Sharma left a lasting impression. The day concluded with **Ram Ki Shakti Pooja** by Varanasi's Rupwani group, directed by Vyomesh Shukla, earning a standing ovation.



Day 2 featured a panel discussion on **Cinema: Mere Entertainment or a Tool for Social Change**, exploring the medium's societal impact. Cultural performances included an elegant Kathak recital by Sangeeta Srivastava and Amrita Bhushan, a semi-classical musical presentation by Kolkata-based artists, and **Shyam-e-Qawwali** by Yusuf Khan Nizami of the Sikandarabad Gharana. The evening concluded with a Hindustani classical concert by Padma Shri Dr. Soma Ghosh and a dynamic fusion act, **Ragon ke Rang**, led by pianist-composer Anirudh Verma.



Day 3 Akshar 2024 concluded the literary fest on a high note with Dr. Alok Bajpai's insightful session **Krishna Vachya**, followed by a talk on **Technological Innovations in Indian Languages** by IIT Kanpur's Prof. Nishith Srivastava and Prof. Arnab Bhattacharya, highlighting the digital rise of Hindi and regional languages. The festival culminated in a grand **Maha Kavi-Sammelan and Mushaira**, featuring celebrated poets like Mr. Wasim Bareilvi, Mr. Rajesh Reddy, Mr. Wasim Nadir, Mr. Abrar Kashif, Mr. Swayam Shrivastava, Ms. Manu Vaishali, Mr. Ekagra Sharma, and Mr. Siddharth Singh, who mesmerized the audience with their powerful verses and ghazals.



BHARTIYA BHASHA UTSAV

Bhartiya Bhasha Utsav was celebrated at IIT Kanpur on 11th Dec 2024 to honour Shri C. Subramania Bharati. The event featured talks by Prof. Braj Bhushan, Prof. Shalabh, and Prof. Arnab Bhattacharya on language, fonts, and technology. An Open Mic showcased students' vibrant performances in multiple Indian languages, celebrating India's linguistic diversity.



NAVANKUR

Shivani Centre and Hindi Sahitya Sabha jointly celebrated **Vishwa Hindi Diwas** with a vibrant two-day festival on January 4 and 5, 2025, featuring the **Anantini** Kavi Sammelan and Abhyuday Storytelling Session. On January 4, 2025, **Anantini** brought together renowned poets like Ekagra Sharma, Babusha Kohli, Varun Anand, and Gaurav 'Sakshi', who beautifully explored themes of love, life, and resilience through powerful verses. Abhyuday revived the magic of kahani with storytellers Mehek Mirza Prabhu and Amandeep Khyal, leaving the audience spellbound with tales like **"Aaji Ki Coffee"** and **"Mere Haath Ki Chai."**



WORKSHOP

On May 3, 2024, Shivani Centre hosted a Hindi poetry workshop led by renowned poet Ms. Shipra Singh. Her recitations and practical tips enriched the audience's understanding of poetic techniques.



COMPETITION ON CREATIVE WRITING

To mark Munshi Premchand's 144th birth anniversary, Shivani Centre and Hindi Sahitya Sabha organized a Creative Writing Competition at IIT Kanpur on 31st July 2024. Around 80 students participated, exploring themes like meeting Premchand, his characters, and women in his works. The event fostered creativity and deepened appreciation for Premchand's literary legacy.

HINDI-PAKHWADA

To mark Hindi Diwas 2024, Shivani Centre, Rajbhasha Prakoshth, and Hindi Sahitya Sabha organized a two-week **Hindi Pakhwada** at IIT Kanpur during 17-30 Sept. 2024. The celebration included dictation, essay and story writing, speech, and quiz competitions, encouraging students especially non-Hindi speakers to engage with the language creatively.



ACTIVITIES CONDUCTED

PG ORIENTATION PROGRAM AT IIT KANPUR

The PG Orientation at IIT Kanpur introduced new students to the Shivani Centre, highlighting its work in promoting Indian languages through events, workshops, and educational content development. Prof. Ark Verma and Ms. Maitreyi Agarwal explained the Centre's initiatives and addressed student queries, making it an engaging and informative start to the academic year.



VISIT OF MR. RAJEEV RANJAN

Mr. Rajeev Ranjan, (BT/EE/1990) visited Shivani Centre and was welcomed by faculty, staff, and international students. He was briefed on the centre's initiatives in literature, language training, and cultural programs. He appreciated the efforts in promoting Hindi and visited the Shivani Memorial Hall. His visit offered valuable insights for future activities.

ACADEMIC CONTENT CREATION BY NSS VOLUNTEERS

Shivani Centre, with guidance from NSS Coordinator Prof. Niraj Mohan Chawake, is supporting non-English background students at IIT Kanpur by creating academic content in Hindi and regional languages. Twenty NSS volunteers are producing audio-video and translated materials for key courses. The Centre provides resources and space, fostering inclusive learning and social service.

TOASTMASTERS CLUB



The Toastmasters Club at IIT Kanpur, supported by alumnus Mr. Suresh Bazaj (MSc2/PHY/1971) in June 2022, works in close coordination with the Students' Placement Office to help students enhance their public speaking, communication, and leadership skills. It is a student-led, self-learning initiative where members participate in regular meetings, workshops, and leadership training sessions designed to boost confidence, articulation, and professional readiness.

From orientation programs for new students to advanced workshops on impromptu speaking, phonetics, and interview preparation, the club offers a structured yet engaging platform for personality development. With the formation of a fifth club this year and consistent participation in campus and off-campus sessions, the initiative continues to grow. Over 100 students braved the winter chill to attend a power-packed session on interview readiness and

confidence building led by DTM Deepak Menon whereas Dr. Garima Williams conducted an engaging session on phonetics, helping students sharpen their speech clarity and professional communication. IIT Kanpur was once again recognised with the prestigious 'Communication & Leadership Award' by Toastmasters International — the only institute in the subcontinent to earn this honour.



THE MEHTA FAMILY CENTER FOR ENGINEERING IN MEDICINE



The Mehta Family Center for Engineering in Medicine (MFCEM) at IIT Kanpur has been established through the generous support of Mr. Rahul Mehta, CEO of the Mehta Family Foundation. This visionary initiative aims to integrate IITK's engineering excellence with cutting-edge biomedical research from the Department of Biological Sciences & Bioengineering (BSBE). The center serves as a hub for developing innovative, engineering-based solutions to complex medical challenges.

Focusing on three major areas—Regenerative Medicine, Molecular Medicine & Engineering, and Digital Medicine—the MFCEM promotes interdisciplinary collaboration across various science and engineering departments. It also strengthens academic offerings through integrated Ph.D. programs, MS by research, and undergraduate minors. With upgraded infrastructure and research opportunities, the center is set to transform healthcare innovation and position IIT Kanpur as a leader in the field of translational medicine.

In 2024–2025, the Mehta Family Center for Engineering in Medicine (MFCEM) at IIT Kanpur achieved key milestones with faculty earning national recognition, patents being filed, and hosting the Pan-IIT Conference on Engineering in Medicine with participation from 31 institutes. The event, inaugurated by Shri Ranjan Kumar (IAS), focused on Regenerative, Molecular, and Digital Medicine. Additionally, a new M.Tech. program in Biomedical Engineering was launched in collaboration with BSBE and GSMST, featuring a unique clinical immersion at top medical schools starting July 2024.

MFCEM DIALOGUES

Dr. Umrao Monani, De Vivo Professor of Neurology, Columbia University Medical Center, delivered a lecture on “Mechanisms underlying infantile-onset spinal muscular atrophy: Clues from a novel disease modifier” on August 20, 2024.



Dr. Anil Koul, VP & Head, Global Public Health discovery, J&J & a member of the Board of Directors of Janssen Pharmaceuticals delivered a lecture titled “Discovery of Bedaquiline and Its Impact on the Global TB Landscape” on February 21, 2025.

AWARDS & RECOGNITIONS

PROF. ASHOK KUMAR

(Department of Biological Sciences & Bioengineering)

- Honorary doctorate, DSc (Tech) by Aalto University, Finland
- Elected Fellow of International Academy of Medical and Biological Engineers (IAMBE), class of 2024
- Elected Fellow of the Indian National Academy of Engineers (INAE) for the year 2024
- Elected Fellow (2024) of the National Academy of Medical Sciences (NAMS), Ministry of Health and Family Welfare, Government of India
- Honorary membership in the Romanian Society of Biomaterials
- Selected for Poonam and Prabhu Goel chair professor



PROF. BUSHRA ATEEQ

(Department of Biological Sciences & Bioengineering)

- TATA Innovation Fellowship 2023-24
- The Rajib Goyal Prize conferred by the Kurukshetra University
- Rashtrapati Bhawan, invited for an "At Home" by the Honourable President Smt. Droupadi Murmu
- Inaugural edition Grihshobha Inspire Award, 2024
- Selected for the World Academy of Sciences (TWAS)- UNESCO Award (2026) in Medical & Health Sciences.
- Elected Fellow (2024) of the National Academy of Medical Sciences (NAMS), Ministry of Health and Family Welfare.
- CSIR-ASPIRE Grant



PROF. DEBANJAN DASGUPTA

(Department of Biological Sciences & Bioengineering)

Ignite Life Science Foundation Award



PROF. DHIRENDRA S. KATTI

(Department of Biological Sciences & Bioengineering)

Appointed Director, IIT Goa

GRANTS



**PROF. SARAVANAN
MATHESHWARAN**

(Department of Biological
Sciences & Bioengineering)

Centre of Excellence in
Antimicrobial Resistance (2024)

DBT- Frontiers in Biotechnology
SERB, Gov. of India.



PROF. APPU KUMAR SINGH
(Department of Biological
Sciences & Bioengineering)

ICMR Intermediate Grant



PROF. RAKESH KUMAR MAJHI
(Department of Biological
Sciences & Bioengineering)

ICMR Intermediate Grant



PROF. BUSHRA ATEEQ

Department of Biological
Sciences & Bioengineering

CSIR-ASPIRE



PROF. SANDEEP VERMA

Department of Biological
Sciences & Bioengineering

WCF, New Delhi



PROF. JAYANDHARAN G RAO

Department of Biological
Sciences & Bioengineering

SUPRA, Anusandhan National
Research Foundation (ANRF), DST

EVENTS

- MFCEM organized the Pan-IIT Meeting and Research Conference on Engineering in Medicine, 2024, which was held from 6th to 8th December.
- A one-day conference on metabolic disorders titled **“Innovative solutions for metabolic health”** was held on 27th Sep. 2024.
- The Rice-IITK Workshop on **“NeuroTech Innovations in the areas of clinical neuroscience, computational neuroscience, and Neuroengineering”** was conducted on 21st Nov.2024.

CHANDRAKANTA KESAVAN CENTER FOR ENERGY POLICY AND CLIMATE SOLUTIONS



Established through the generous support of **Mr. Sudhakar Kesavan (BT/CHE/1976)**, who currently serves as Chairman of the Board of ABM Industries and former Executive Chairman and CEO of Inner-City Fund (ICF), who led the firm to become the world's first carbon-neutral professional services company—the Center is grounded in both vision and action. Anchored in the Department of Sustainable Energy Engineering, it aims to make IIT Kanpur carbon neutral by 2027 while emerging as a national and global leader in energy and climate policy. With a strong focus on research, outreach, and collaboration with governments and civil society, the Center develops scalable, science-driven solutions to address climate challenges. It serves as a dynamic platform uniting technologists, academics, and policymakers to shape a cleaner, more equitable future for India and the world. The Center is steadily progressing toward becoming a leading voice in India's clean energy and climate policy landscape. Continued institutional support, strategic partnerships, and a focus on actionable research will be key to its impact.

LECTURE SERIES

Dr. Rodion Stepanov, Institute of Continuous Media Mechanics, Perm, Russia.

Title- 'WRF' Simulations of Mid-Latitude Atmospheric Waves' on April 4, 2024.

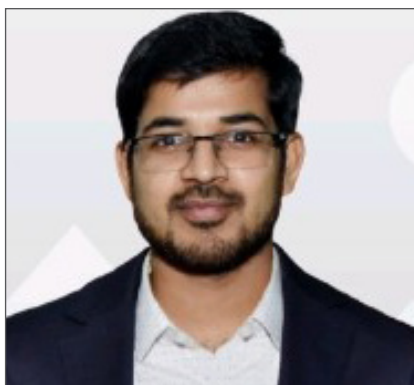

Mr. Pawan Joshi, Senior Manager, Tata Motors, Pune, India

Title- 'My experiences with the Automobile Industry' on April 9, 2024

Mr. Manojit Sengupta, Delivery Centre Head - Eastern Region, TCS

Title- 'Sustainability in Power Utility Sector' on February 11, 2025.



Mr. Chaitanya Gade, Head of Sustainability Monitoring and Evaluation at Govardhan Eco Village'

Title- 'Exploring Sustainable Solutions: The Symbiotic Recycling Model of Govardhan Eco Village' on April 16, 2024



Mr. Chandrashekar Chincholkar, Director - Corporate Advisory at CES India Pvt Ltd, Pune

Title- 'Board Strategy for ESG and Corporate Sustainability - Understanding the BRSR' on June 28, 2024.

Mr. Manish Chourasia, Managing Director of Tata Cleantech Capital

Title- 'Navigating Climate Finance: Empowering Future Leaders for Sustainable Change' on August 14, 2024.



Mr. Ajay Phatak, Trustee, The Ecological Society, Pune

Title- 'Energy Transition, challenges and opportunities' on Aug 29, 2024.

Prof Husain Kanchwala, Assistant Professor in the Center of Automotive Engineering and Tribology at IIT Delhi

Title- 'Research paradigms in Automotive Engineering' on August 31, 2024.



Dr. Sudhanshu Shukla, Senior Researcher at Interuniversity Microelectronics Centre (IMEC), Belgium

Title- 'Addressing the Material Challenges for Photoelectrochemical Solar Fuels Generation: Lessons from Photovoltaics' on December 19, 2024.

Dr. Asit Kumar Mishra, Research Engineer, Marie Sklodowska-Curie fellow

Title- 'Designing classrooms of the future - Sustainability, resilience, and health' on January 3, 2025.



Dr. Virender K. Sharma, Professor at the Department of Chemical, Environmental, and Material Engineering at the University of Miami, Florida

Title- 'Ferrates in Water, Energy, Food, and Human Health' on January 29, 2025.

OUTREACH ACTIVITIES

The prestigious Dr. Chandrakanta Kesavan Best Research Thesis Award was instituted by the Kesavan Center at IIT Kanpur to recognize the best-graduating full-time Master's student from any department who has completed his Master's thesis in energy sustainability and climate solutions. The award is open to students of all departments. This year, the award was given to three outstanding researchers: Siddharth, Gudelli Shivakumar, and C Navya Nirmala, in recognition of their thesis work in this field.



SIDDHARTH

Sustainable Energy Engineering

GUDELLI SHIVAKUMAR

Sustainable Energy Engineering

C NAVYA NIRMALA

Chemical Engineering

Held on 05–06 November 2024 at the Outreach Auditorium, IIT Kanpur, the **Schmidt Sciences Conference** on “Energy Technologies for India’s Decarbonization” brought together leading national and international experts. This high-impact, two-day event focused on innovative technologies and strategic policy frameworks to accelerate India’s transition toward a sustainable, low-carbon future.

On 31 August 2024, the fourth edition of **NetZero Dialogue** was held at ATREE, Bangalore, focusing on “Socio-ecological Considerations for Renewable Energy Projects.” This one-day workshop fostered meaningful dialogue among researchers, policymakers, and practitioners, addressing the critical balance between renewable energy expansion and socio-ecological sustainability.

The **Sustainable GeoCommunities Workshop**, held on 24–25 June 2024 at IIT Kanpur’s Outreach Center in Noida, focused on community-driven sustainability and decentralized energy systems, highlighting geospatial tools and stakeholder engagement in rural and peri-urban settings.

COMMUNITY OUTREACH

CKC conducted many Life and Carbon Climate Change Awareness events on Saturdays and Sundays in October 2024. These events were attended by over 200 enthusiastic students from Sunshine Public School, Prayas, and Opportunity School. The events sparked thought-provoking discussions on climate change, its causes, and the impact of overconsumption, racism, and unchecked ambition.

As part of a Cleanliness Drive initiated by the Chandrakanta Kesavan Centre (CKC), over 150 motivated IIT Kanpur students collected up to 300 kg of plastic waste from areas such as Ganga Barrage and parks like Kargil Park. These drives were conducted almost every Sunday from August to November.

RESEARCH INFRASTRUCTURE



Field Emission Scanning
Electron Microscopy
(FESEM)- Thermo Fisher
Scientific Apreo 2C

BET Surface Area
Analyzer – Autosorb



X-Ray Diffraction
(XRD)- Rigaku
SmartLab SE



Stylus Profiler System -
Bruker Dektak

HEMO-COMPATIBLE SURFACES FOR LEFT VENTRICULAR ASSIST DEVICES (LVADS)



The objective of this study is to develop hemocompatible and non-thrombogenic surfaces. To demonstrate hemocompatible and antibacterial Ti6Al4V alloy surfaces, we have used a variety of surface texturing [powder sintering (PS) and sand blasting (SB)] and coating techniques. In this study, PS and SB were used to create textured surfaces, enhancing surface roughness ($R_a \sim 16\text{--}17 \mu\text{m}$) and hydrophobicity, crucial for blood compatibility. Additionally, a smooth, superhydrophobic, and durable blood-repellent surface was developed by sputtering metal catalysts (Ti, Cu, Ag, Zn) followed by carbon nanofiber (CNF) growth via chemical vapor deposition (CVD). Co-sputtering (Ag-Cu, Zn-Cu) was also explored to enhance multifunctionality. The coated surfaces, such as Ti-CNF, Cu-CNF, Ag-CNF, and Zn-CNF, demonstrated contact angles of 135° , 148° , 129° and 144° with water and 139° , 143° , 141° and 145° with blood, respectively. Antibacterial properties were evaluated using both quantitative (MTT assay) and qualitative (SEM imaging) methods against *E. coli* and *S. aureus* bacteria. CNF-coated surfaces significantly reduced bacterial adhesion and viability compared to the control (glass). Results indicated a notably superior antibacterial response in all of the non-coated and CNF-coated Ti alloy substrates when compared to the glass control. Moreover, Ti, Cu, Ag, Ag-Cu, Zn, and Zn-Cu sputtered CNF-coated samples show further reduction in bacterial viability. SEM analysis revealed morphological disruption in bacterial cells on coated substrates. The findings highlight that surface topography, hydrophobicity, and incorporated antibacterial agents synergistically enhance the antibacterial and hemocompatible properties of Ti6Al4V alloy. In addition, CNF-coated surfaces exhibited significantly reduced protein adsorption, attributed to their hydrophobic nature, which also contributed to decreased bacterial and platelet adhesion. In contrast, PS and SB surfaces showed increased protein adsorption due to their surface roughness. Cytotoxicity was assessed using MG-63 human osteoblast-like cells via MTT and LDH assays. MTT results indicated that all tested surfaces, including CNF-coated, PS and SB, were non-toxic. Plasma-free hemoglobin assays demonstrated that CNF coatings effectively delayed blood coagulation, enhancing hemocompatibility. Platelet adhesion studies confirmed minimal platelet accumulation on CNF-coated surfaces. Furthermore, ICP-AES analysis revealed controlled ion leaching from CNF-coated samples in simulated body fluid, suggesting additional antibacterial potential due to released Zn, Cu, and Ag ions. The results highlight that surface modification using CNF coatings enhances the blood- and cell-compatible nature of Ti6Al4V implants, suggesting their potential in next-generation biomedical devices.

In addition, we also investigated the biotribological behavior of CNF-coated Ti-6Al-4V surfaces under both dry and simulated body fluid (SBF) conditions to know the protective effects of CNF coatings on the Ti6Al4V surfaces. The coefficient of friction (COF) and wear rate were evaluated for uncoated and CNF-coated surfaces (Ti, Cu, Ag, and Zn). Results revealed that all CNF-coated surfaces exhibited lower COF values compared to uncoated Ti6Al4V in both conditions, indicating improved frictional performance. Notably, Cu-CNF showed the lowest COF and wear rate, particularly in dry conditions. Wear scars analyzed by SEM and 3D optical profilometry demonstrated reduced wear depth and smoother surface profiles on coated samples, confirming the protective nature of the CNF coatings. While the uncoated Ti6Al4V exhibited abrasive wear with parallel ploughs and delamination, coated surfaces showed significantly milder wear. These findings point out the importance of CNF coatings in enhancing the wear resistance and tribological performance of Ti6Al4V alloys.

Key Highlights:

- Textured surfaces of Ti6Al4V alloy were fabricated using powder sintering and sand blasting exhibiting good adhesive strength. The CNF coating was developed on the surfaces of Ti6Al4V alloy substrates in two steps, first is sputtering/co-sputtering (of Cu, Ti, Ag, Zn, Ag-Cu, Zn-Cu) followed by chemical vapour deposition.
- The CNF coated surfaces exhibit water and blood repellence, as confirmed by contact angle measurement. These surfaces also show excellent antibacterial activity compared to uncoated ones. While textured surfaces enhance protein adsorption, indicating platelet adhesion potential. In addition, CNF coating significantly reduces protein adsorption due to hydrophobic nature.
- Platelet adhesion assay shows that non-coated Ti6Al4V, powder sintered (PS), sandblasted (SB) surfaces shows higher platelet adhesion in compression to that of SB-CNF, PS-CNF, Zn-CNF, Ag-CNF, Ti-CNF and Cu-CNF coated Ti6Al4V alloy substrates.
- Cytotoxicity was evaluated using MG-63 cells on CNF coated and textured surfaces showing no toxic effects. Also lactate dehydrogenase (LDH) assay results confirms that the non-coated Ti6Al4V, Ti-CNF, Cu-CNF, Ag-CNF and Zn- CNF coated surfaces show the minimum LDH release as compared to the positive control. Also, there are no significant differences observed between the non- coated Ti6Al4V, Ti-CNF, Cu-CNF, Ag-CNF and Zn-CNF coated surfaces and the negative control.
- Plasma free hemoglobin (mg/dL) assay demonstrates that non-coated Ti6Al4V, powder sintered (PS), sandblasted (SB) shows higher hemoglobin as compared to that of SB-CNF, PS-CNF, Zn-CNF, Zn-Cu-CNF, Ag-CNF, Ag-Cu-CNF, Ti-CNF and Cu-CNF coated Ti6Al4V substrates. The statistical analysis shows that there is no significant difference in all the titanium surfaces.
- The biotribological test results illustrated that the COF and wear rate of Ti-CNF, Cu-CNF Ag-CNF, and Zn-CNF coated Ti6AL4V alloy substrates under dry friction and SBF solution were lower as compared to Ti6AL4V substrates.

CAMPAIGNS & MEMORIAL FUNDS

IIT Kanpur runs year-round campaigns that promote academic excellence, advance social good, and institutional growth. These efforts support a wide range of faculty and student initiatives, including research, infrastructure, and endowment development—driving meaningful and lasting change.

P.T. NARASIMHAN PERFORMANCE ARTS INITIATIVE



The P.T. Narasimhan Fund for Performing Arts at IIT Kanpur has been established with a foundational grant from the children of Prof. P.T. Narasimhan: Dr. Nalini Murdter (MSc2/CHM/1979), Dr. Vikram Narasimhan (MSc5/CHM/1984), and Dr. Nandini Narayan. The fund supports a concert series on the IIT Kanpur campus, featuring performances by prominent Indian classical musicians. Its aim is to nurture holistic student development by promoting theatre, music, and dance on campus. This initiative aligns with the goals of IIT Kanpur's APPROACH (Appreciation and Promotion of Art, Culture, and Heritage) Cell, established in 2022.

The late Prof. P.T. Narasimhan was an internationally recognized scientist and one of the founding faculty members of the Chemistry Department at IIT Kanpur. He completed his M.Sc. at Madras Christian College and earned his Ph.D. from IISc Bengaluru.

Affectionately known as "PTN" to many, he had a deep love and appreciation for Indian classical music and was instrumental in bringing many leading musicians to perform on campus.

Prof. Narasimhan received numerous honors during his career, including the Fellow of the Indian Academy of Sciences (1970), the Shanti Swarup Bhatnagar Prize (1970), the IIT Kanpur Institute Fellowship (2009), Fellowship of the Indian National Science Academy, and Fellowship of the National Academy of Sciences (1973).

With generous support from alumni, INR 81 lakhs was raised to upgrade the music room, improve rehearsal spaces, and enrich cultural activities across the campus.

PROF. N. SATHYAMURTHY ENDOWMENT LECTURE SERIES



In honor of Professor N. Sathyamurthy, the Prof. N. Sathyamurthy Lecture Series has been instituted through the generous support of his students, collaborators, family, and well-wishers.

This annual series brings eminent scientists both national and international to engage with the IITK community, fostering exposure to research and leadership.

The initiative aims to celebrate academic excellence and broaden the intellectual horizons of both students and faculty.

Professor N. Sathyamurthy, a distinguished chemist and former Director of IISER Mohali, served IIT Kanpur from 1978 to 2007, rising from Lecturer to Institute Chair Professor. Renowned for his groundbreaking work in theoretical and computational chemistry and deeply admired as an approachable mentor, his legacy continues to inspire generations of scholars.

INR 25 lakhs were raised through alumni contributions to establish and sustain this prestigious lecture series.

PROF. KANWAR NALWA MEMORIAL SCHOLARSHIP CAMPAIGN



In fond memory of Late Prof. Kanwar S. Nalwa, a visionary scientist and beloved member of the IIT Kanpur community, a merit-cum-need based scholarship has been established to support undergraduate students in the Department of Physics who face

financial hardship. This initiative, established by his family, friends, colleagues, and former students, serves as a tribute to both his scientific legacy and human spirit. The aim is to empower meritorious undergraduate students in Physics by providing financial support to help them overcome economic barriers and pursue academic excellence.

An alumnus of IIT Kanpur and a PhD from Iowa State University, Prof. Nalwa was widely respected for his path breaking research in organic semiconductors, perovskite solar cells, and energy storage. Beyond his academic brilliance, he was known for his humility, mentorship,

and quiet strength that inspired everyone around him.

The campaign culminated in raising INR 25 lakhs, ensuring sustained annual support for deserving young physicists at IIT Kanpur.

PROF. VINOD K. SINGH DISTINGUISHED LECTURE SERIES – DEPARTMENT OF CHEMISTRY



A Distinguished Lecture Series has been established in honor of Prof. Vinod K. Singh by his family, friends, and students. He is a distinguished academician, scientist, and leader in the field of synthetic organic chemistry, a Padma Shri awardee, and a respected academic administrator who currently serves as Professor Emeritus at IIT Kanpur.

The lecture series celebrates his lifelong commitment to scientific excellence and mentorship by hosting eminent speakers in the fields of organic, theoretical, and computational chemistry. Designed to inspire students, faculty, and researchers alike, this biennial initiative reflects IIT Kanpur's ongoing pursuit of academic enrichment.

Prof. Singh has had a career spanning over three decades, during which he has made transformative contributions to research, education, and institution-building in India including his foundational role in establishing IISER Bhopal.

A total of INR 18 lakhs has been raised through generous alumni contributions, with fundraising efforts actively continuing.

V. SRINIVASAN MEMORIAL FUND – A TRIBUTE BY THE CLASS OF 1990



The Class of 1990 at IIT Kanpur launched a campaign in memory of Mr. Venkateswaran Srinivasan (BT/EE/1990) to honor his legacy and lifelong commitment to education. The campaign envisions supporting meritorious students at IIT Kanpur as well as underprivileged children at Opportunity School, reflecting his belief in equitable access to learning.

A brilliant educator, technologist, and mentor, Mr. Srinivasan was known for his passion for teaching and deep expertise in physics, mathematics, and engineering. He left a lasting impact through his roles at institutions such as the Rani Institute of Scholastic Education, Amazon Development Center, and as a tutor on global platforms. His career began with notable contributions to fiber optic communication and power distribution automation at IIT Kanpur, and his devotion to education remained steadfast until his final moments.

Through the heartfelt support of alumni, INR 26 lakhs have been raised carrying forward his legacy to empower countless young minds.

ANNUAL GIVING CAMPAIGN



The Annual Giving campaign is a recurring initiative that brings together IIT Kanpur's alumni, donors, and well-wishers to make flexible, unrestricted contributions. These funds empower the Institute to address its most urgent priorities ranging from student scholarships and faculty fellowships to infrastructure, research, and community support.

By allowing the Institute to allocate resources where they are needed most, Annual Giving plays a vital role in sustaining academic excellence, equity, and innovation. Donors stay informed and connected through platforms like IITKonverge, which offer regular updates and transparent reporting on the impact of their contributions. Participating in Annual Giving is more than a donation, it's an investment in IITK's future and a shared legacy of transformative education and opportunity.

This year, the campaign raised an impressive INR 2.15 Crore through collective donor support, reaffirming the transformative power of consistent giving.

MAGIK: MONTHLY ALUMNI GIVING FOR IIT KANPUR



M.A.G.I.K. (Monthly Alumni Giving for IIT Kanpur) is a structured monthly giving program designed to engage IIT Kanpur alumni in sustained support of their alma mater. This voluntary initiative provides alumni with a meaningful avenue to contribute regularly, with the goal of advancing student success and strengthening the institution's long-term impact. Formerly known as IITKontribute,

the program was rebranded in FY 2024-25 to more accurately embody its mission and to inspire deeper, ongoing alumni involvement. M.A.G.I.K. offers a streamlined yet impactful approach to giving, promoting a culture of philanthropy that benefits both students and the Institute. Monthly contributions are pooled into batch-specific legacy funds, which are directed toward projects that reflect the values and vision of each graduating class.

STUDENTS INITIATIVES

IIT Kanpur takes pride in nurturing its students through a range of initiatives that foster excellence, innovation, and leadership. The institute receives generous contributions from its alumni and well-wishers to support programmes such as scholarships, travel grants, and research opportunities. Each contribution strengthens IIT Kanpur's mission to create an inclusive and inspiring learning environment that empowers every student to achieve their highest potential.

57th CONVOCATION OF IIT KANPUR

The 57th convocation of IIT Kanpur was held on June 29, 2024. The momentous occasion was graced by the President of Oregon State University, USA (OSU), Prof. Jayathi Murthy, an IITK alumna, as the Chief Guest. Dr. Radhakrishnan Koppillil, Chairperson, Board of Governors (BoG), IIT Kanpur and Prof. Manindra Agrawal, Director, IIT Kanpur presided over the highly anticipated ceremony.



Kunwar Preet Singh, Computer Science & Engineering, awarded, President's Gold Medal



Viplav Patel, Chemical Engineering-Electrical Engineering, awarded, the Director's Gold Medal



Sarthak Kohli, Computer Science & Engineering, awarded, Director's Gold Medal



Tejas Ramakrishnan, Computer Science & Engineering, awarded, Ratan Swarup Memorial Prize



IITKANPUR'S
57TH
CONVOCAATION
Outstanding PhD Thesis
Awardees

 ANKITA DAS Biological Sciences & Bioengineering	 PARAS SACHDEVA Economic Sciences	 DEEKSHA JACHPURE Photonics Science and Engineering Programme
 SUAIBA ALI MUFTI Civil Engineering	 KRISHNENDU PAUL Earth Sciences	 JAGANNATH MAHARANA Biological Sciences & Bioengineering
 VIKRAM CHOUDHARY Civil Engineering	 SOUVIK NASKAR Mechanical Engineering	 AMUDALA DHEERAJ NAIDU Electrical Engineering
 ISHAN SINGHAL Cognitive Science	 VIVEK GUPTA Mechanical Engineering	 SUBHRA SOURAV JANA Materials Science & Engineering
 PRATEEK DWIVEDI Chemical Engineering	 SUGANDHA SINGH Materials Science Programme	 KOMAL SINGH CHAUHAN Humanities & Social Sciences
 HAIDER ALI Chemical Engineering	 BIDISHA BHATT Physics	 SAMIRAN GHOSH Mathematics & Statistics
 MOHAMED ANIFFA. S Aerospace Engineering	 RAVI MALIK Chemistry	 PRIYANKA CHAKRABORTY Chemistry
 SHREYASI SOM Electrical Engineering	 ABHISHEK VERMA Design Programme	 GANESH CHANDRA UPRETI Chemistry

Twenty-Six Outstanding PhD Thesis Awards were given out on Convocation Day. It recognized the exceptional work of the PhD Students.



Congratulations to the graduates of 2024

CONVOCATION AWARD RECIPIENTS

Name	Benefactor	Recipient	Department
President's Gold Medal	IIT Kanpur	Kunwar Preet Singh	CSE
Director's Gold Medal (4-year UG program)	IIT Kanpur	Sarthak Kohli	CSE
Director's Gold Medal (5-year UG program)	IIT Kanpur	Viplav Patel	CHE-EE
Ratan Swarup Memorial Prize	Mr. Ratan Swarup	Tejas Ramakrishnan	CSE
Trilok Chandra Goel Memorial Gold Medal	Mr. Sudhanshu Goel	Subhra Sourav Jana	MSE
Sri Binay Kumar Sinha Award	Mr. Suyash Sinha	Jaya Gupta	CSE
		Harshit Bansal	CSE
Dr. Shankar Dayal Sharma Medal	Mrs. Vimla Sharma	Garima Bawa	PHY
IITK Excellence for Leadership in Students Affairs	IIT Kanpur	Dhwanit Balwani	CHE
		Prashant Kumar Mishra	ECO
		Sunay Chhajed	MSE-ECO
		Deepanshi Maheshwari	MSE
IITK Excellence in Art & Cultural Activities	IIT Kanpur	Kaustubh Agrawal	CHE
		Parth Bhatt	CE
		Anjali Jain	CE
		Kale Rohit Ramesh	CHM-ECO
		Adarsh K	BSBE
		Nikhil Singh	CE
IITK Excellence in Community Services	IIT Kanpur	Mohammad Imad Khan	CE-EE
		Sujal Harkut	EE
		Sanika Gumaste	EE
		Shivangi Yadav	CE
		Anshika Singh	MSE
		M Aravind	EE
SIIC Student Innovation Award (SSIA)	DORA & DORD, IIT Kanpur	Debjani Das	BSBE
		Arindam Mitra	EE
Best Software Award	Prof. Pankaj Jalote	Hrishikesh Rajesh Terdalkar	CSE
		Ahtisham Ul Haq Pampori	EE
Ranjan Kumar Memorial Award	Friends of Late Ranjan Kumar	Harshit Raj	CSE
Best All-Rounder Girl Student of 2-year Master's Programme Gold Medal	Prof. P.K. Kalra	Mansi Pradip Koshti	CE
Bhagwani Devi Maheshwari Gold Medal	Prof. S.N. Maheshwari	Gauri	CE
Dr. Rukmini Saraswat Gold Medal	Shri Vijay Saraswat	Citika Mittal	AE
Dr. Elizabeth and Dr. Varkey Cherian Award	Mr. Cherian Mathew	None Found Suitable	
Vibha Gold Medal	Mr. Amit Narayan	Shambhavi Sabharwal	ME

Proficiency Prizes/Medals	IIT Kanpur	Utpal Kundu	CHM
		Teki Sai Veerabhadra Nikhil	CHM
		Aayush Kumar	CSE
		Himanshu Jindal	EE
		Adit Thampi	MSE
		Vinit Sinha	MTH
		Jaskirat Singh	MTH
		Pranay Agarwal	MTH
		Suyash Srivastava	MTH
		Aman Khosla	PHY
Bhagavatula Project Award	Mr. Ravi S. Bhagavatula	Adsule Harish Sunil	PHY
Dr. Vishwanath Bajpai Memorial Gold Medal	Late Prof. V.N. Bajpai Mrs. Ila Bajpai	Ashmita Dasgupta	ES
Mrs. & Mr. S. N. Mittal Gold Medal	Prof. Ashok K. Mittal	Abhishek Kumar Singh	IME
IEEE/PEDES' 96 Award	Prof. S.S.Murthy IIT Delhi	Madyahnam Parashu Ramudu	EE
Mars G. Fontana Prize	Institute money (Account I)	Harsh Agarwal	MSE
Mehta M. Tech. Gold Medal	Dr. Gurmukh D. Mehta	Kondru Sivakumar	ME
Prof. ASR Sai Gold Medal	Family & Friends (Civil Engineering Department)	Prajakta Prasad Kapre	CE
Prof. ASR Sai Memorial Medal	Mrs. J.J. Adidam	Aryash Pateriya	CE-CSE
Shri Ghisa Lal Kamdar Memorial Medal	Mrs. Usha Kamdar	Ayush Raj	CHE
Prof. Samares Kar Memorial Gold Medal	Dr. Rita Kar	Aditya Krishna Rao	EE
Kunwar Devendra Pratap Singh & Kunwarani Krishna Kumari Memorial Award	Mr. Anil Singh	None Found Suitable	
Smt. Shashi Pundir Memorial Medal	Prof. B. P. Pundir	Rahul Pandey	ME
Dr. S.D. Bokil Memorial Medal	Civil Engineering Department IITK	Saurabh Kumar Maurya	CE
Shailja Srivastava Award	Mr. Puneet Prakash	None Found Suitable	
Dr. Vijay K. Varma Talent Award	Dr. Vijay K Varma	Burila Om Prakash	EE
Envirotech GD Agrawal Award	Mr. S.K. Gupta	Surya Sujathan	CE
		Akshat Verma	CE
Dr. Chandrakanta Kesavan Best Research Thesis Award	Mr Sudhakar Kesavan	Gudelli Shivakumar	SEE
		C Navya Nirmala	CHE
		Siddharth	SEE
Dr. Chandrakanta Kesavan Best Research Project Award	Mr Sudhakar Kesavan	None Found Suitable	

Rajiv and Ritu Batra student Award in Cyber Security	Mr. Rajiv Batra	Kush Shah	CSE
Govind Swarup Memorial Award	Mr. Mahesh Swarup Agarwal	None Found Suitable	
Sangeeta Pradhan Memorial Medal	Mr. Anil Kumar Pradhan	Paulomi Das	STAT
Karandikar Best Ph.D. Thesis Award	Mr. Ashish Karandikar	Arindam Mitra	EE
Manas Mandal Best Ph.D. Thesis Award	Dr. Manas Mandal and Dr. Soma Mandal	Priyanka Golia	CSE
Prof. Baldeva Upadhyay Gold Medal	Late Prof. G.S Upadhyaya	Jyoti Kumari	MSE
Outstanding Ph.D. Thesis Award	IIT Kanpur	Mohamed Aniffa. S	AE
		Jagannath Maharana	BSBE
		Ankita Das	BSBE
		Suaiba Ali Mufti	CE
		Vikram Choudhary	CE
		Ishan Singhal	CGS
		Prateek Dwivedi	CHE
		Haider Ali	CHE
		Priyanka Chakraborty	CHM
		Ganesh Chandra Upreti	CHM
		Ravi Malik	CHM
		Abhishek Verma	DES
		Paras Sachdeva	ECO
		Shreyasi Som	EE
		Amudala Dheeraj Naidu	EE
		Krishnendu Paul	ES
		Komal Singh Chauhan	HSS
		Souvik Naskar	ME
		Vivek Gupta	ME
		Subhra Sourav Jana	MSE
Sugandha Singh	MSP		
Samiran Ghosh	MTH		
Bidisha Bhatt	PHY		
Fahim Varsi	PHY		
Sudipta Dutta	PHY		
Deeksha Jachpure	PSE		
General Proficiency Medals	IIT Kanpur	Yashika Malhotra	AE
		Ashish Ahuja	BSBE-EE
		Aryash Pateriya	CE-CSE
		Pratyush Gupta	CHE
		Teki Sai Veerabhadra Nikhil	CHM

General Proficiency Medals	IIT Kanpur	Kunwar Preet Singh	CSE
		Yash Gupta	ECO-CSE
		Manan Kalavadia	EE
		Rajit Das	ES
		Pranab Pandey	ME-CSE
		Adit Thampi	MSE
		Suyash Srivastava	MTH
		Adsule Harish Sunil	PHY
		Sukhendu Manna	CHM
		Athak Kumar Singh	MTH
		Bismaya Ranjan Nayak	PHY
		Sayantana Sarkar	PHY
Swarnajit Podder	STA		
Professor Burton J. Moyer Memorial Gold Medal	Dr. G.N. Rao	Adsule Harish Sunil	PHY
Professor Putcha Venkateswarlu Memorial Gold Medal	Dr. G.N. Rao	L Gokulnath	CSE
Prof. R.K. Jain Award	Dr. Malai Subbhia Dr.G.P Youvaraj	Swadhin Maiti	MTH
Radhabai Vasudeo Navelkar Award	Mr. Vasudev Dattaram Navelkar	None Found Suitable	
Kanta Devi Malik Memorial Award	Mr. OP Malik	Jaya Gupta	CSE
Bhagwan Das Sanghi Memorial Gold Medal	Family of Late B.D. Sanghi	Pranay Agarwal	MTH
Prof. Vijay Mahajan Award	Prof. Vijay Mahajan	Abhishek Kumar Singh	IME
Banco Foundation Prize	Banco Foundation	Darsh Kumar	ME
Batra Gold Medal	1967 Batch Fund	Dwij Raj Hari	MSE
Suman Gupta Gold Medal	Prof. S.K. Gupta	Bipplav Kumar Tiwari	MTH
Dr. Prateek Mishra Memorial Gold Medal	Family and Friends of Prateek Mishra	Garvit Arora	EE
Mahatma Choa Kok Sui Meritorious award	Mrs. Karuna Sharma	Divyansh Gupta	ECO
Silver Medal for Excellence in Education by Sitaram Jindal Foundation	Sitaram Jindal Foundation	Arth Banka	BSBE
		Sahandeep Das	EE
Chandra Prabha and Charan Dass Gupta Gold Medal	Mr. Anil K Gupta	Jaya Gupta	CSE
Bogineni Chenchu Rama Naidu Gold Medal	Bogineni Chenchu Rama Naidu	Pratap Sharma	MSE
Shrimati Tara Dube and Shri Raj Deva Dube Memorial Gold Medal	Prof. Ravindra Kumar Dube	Harjap Singh	CHE
Raghvendra Shukla Memorial Merit Award	Mr. Jayendu, Mr. Kamalendu, Mr. Manjul and Mr. Shivendu	Vidhi Jain	CHE
Smt. Rani Devi Pathak and Shri Chandra Sen Pathak Memorial Medal	Prof. Anand Pathak	Shiladitya Mondal	PHY

SCHOLARSHIPS

Program Name	Recipient Name	Donor Name
Aedunuthula Prasad Memorial Scholarship	Rohan Batra (BT/CHE)	Mr. Rama Koteswar Rao Aedunuthula
Anil and Reshma Nigam Scholarship	Divyanshi Bansal (BT/AE)	Mr. Anil Nigam
Anita and Santosh Mehra Scholarship	Archit Kumar (BT/EE)	Mr. Santosh Mehra
Anita and Santosh Mehra Scholarship	Smith Bharat Patel (BT/EE)	Mr. Santosh Mehra
Anita and Santosh Mehra Scholarship	Donkena Manideep (Dual/EE)	Mr. Santosh Mehra
Anita and Santosh Mehra Scholarship	Shubham Kumar (BT/EE)	Mr. Santosh Mehra
Anita and Santosh Mehra Scholarship	Dileep Gurjar (BT/EE)	Mr. Santosh Mehra
Arakere and Karen Vasudev Scholarship	Aaditya Amlan Panda (BT/CHE)	Prof. Arakere Vasudev
Arakere and Karen Vasudev Scholarship	Shrimi Agarwal (BT/CHE)	Prof. Arakere Vasudev
Babu Ram Jain and Mrs. Shanti Jain Memorial Scholarship	Abhay Kesarwani (BT/BSBE)	Prof. Ashok K Jain
Balajit and Nirmal Dhindsa Scholarship	Radhika Ashish Darpe (BT/BSBE)	Mr. Ajit Gill
Balajit and Nirmal Dhindsa Scholarship	Anika Gupta (BT/BSBE)	Mr. Ajit Gill
BGM Kumar Foundation Scholarship	Shefali Shukla (Dual/MSE)	Mr. Birendra Kumar
BGM Kumar Foundation Scholarship	Khushi Aggarwal (BT/CHE)	Mr. Birendra Kumar
BGM Kumar Foundation Scholarship	Sapna (BS/ES)	Mr. Birendra Kumar
Sri Bhagwan Das Kapoor and Smt. Padma Kapoor Memorial Scholarship	Khushbu (Dual/CE)	Mr. Arun Kumar Kapoor
Bhagwan Das Sanghi Memorial Scholarship	Khushi Ranawat (BS/MTH)	Prof. Dheeraj Sanghi
Bhuwan and Indira Joshi Scholarship	Keshav Ranjan (Dual/ MTH)	Mr. Vinit Joshi
Bimlavati and Nawal Kishore Kapur Scholarship	Varsha Khandelwal (BT/CE)	Mr. Deepak Kapur
Bishwanath Jha Memorial Scholarship	Jain Shlok Nilesh (BT/CSE)	Mr. Nirmal Jha
Class of 1984 Scholarship	Shambhu Shivanand Khanai (BS/STAT)	Class of 1984
Class of 1984 Scholarship	Vundela Obula Reddy (BT/CSE)	Class of 1984
Class of 1984 Scholarship	Mayur Agarwal (ECO)	Class of 1984
Class of 1984 Scholarship	Pramshu Mangal (MTH)	Class of 1984
Dr. Hari Mohan and Pushpa Srivastava Scholarship	Debraj Karmakar (BT/CSE)	Mr. Amitabh Srivastava

Dr. K.C. Saronwala Memorial Scholarship	Shivram Kathik (BT/EE)	Mr. Anupam Saronwala
Dr. K.P. Gupta Scholarship	Piyush Singal (BT/MSE)	Mr. Shantanu Gupta
Dr. M. Anantaswamy and Mrs. Vijaylakshmi Rau Scholarship	Malik Zadah Irfan (Dual/CHE)	Mr. Pradeep A Rau
Dr. Prateek Mishra Memorial Scholarship	G Sriniketh Balachandar (BT/EE)	Mr. Aman Jain
Dr. R.K. Singhal Memorial Scholarship	Kritnandan (BT/BSBE)	Prof. Sanjay Mittal
Govinda and Indira Srikantiah Scholarship	Kartikeya Katiyar (BT/ME)	Prof. G. Srikantiah
Guru Ji Ghashit Ram Scholarship	Samarth Agarwal (BT/EE)	Late Dr. Ranjit Singh
Guru Ji Ghashit Ram Scholarship	Joel Bansal (BT/EE)	Late Dr. Ranjit Singh
Harish and Sushila Chandra Scholarship	Kundan Kumar (BT/CSE)	Mr. Ashok K. Chandra
Indra Dhanush Award Scholarship	Samyak Singhania (BT/EE)	Mr. Rohit Verma
IWA Bonn Scholarship	Praveen Raj (BT/ME)	Indian Women Association
IWA Bonn Scholarship	Varun Mahajan (BT/ME)	Indian Women Association
IWA Bonn Scholarship	Harsh Wardhan Singh Shekhawat (BT/ME)	Indian Women Association
Jasmine and Mohiuddin's Scholarship	Dhruv Aggarwal (M.Sc/STA)	Mr. Mohiuddin Golam
Jayalakshmi Scholarship	Jiya Agarwal (BT/ME)	Mr. Krishnan Venkatraman
K.N. Saluja Scholarship	Arsh Chauhan (BT/CE)	Mr. Hersh Saluja
K.N. Saluja Scholarship	Vansh Bajaj (BT/CE)	Mr. Hersh Saluja
K.N. Saluja Scholarship	Kushagra Shukla (BT/CE)	Mr. Hersh Saluja
K.N. Saluja Scholarship	Amulya Kumar (BT/CE)	Mr. Hersh Saluja
K.N. Saluja Scholarship	Lali (BT/CE)	Mr. Hersh Saluja
K.N. Saluja Scholarship	Aditya Prakash (BT/CE)	Mr. Hersh Saluja
K.N. Saluja Scholarship	Amipriya Anand (BT/CE)	Mr. Hersh Saluja
K.N. Saluja Scholarship	Pranshu Jain (BT/CE)	Mr. Hersh Saluja
K.N. Saluja Scholarship	Abhay Shukla (BT/CE)	Mr. Hersh Saluja
K.N. Saluja Scholarship	Aman Pratap Yadav (BT/CE)	Mr. Hersh Saluja
Khem Chandra Yadav Scholarship	Madhur Bansal (BS/STAT)	Late Dr. Ranjit Singh
Khem Chandra Yadav Scholarship	Vetcha Pankaj Nath (BT/CSE)	Late Dr. Ranjit Singh
Khemchand Memorial Scholarship	Ayush Raj (BS/MTH)	Mr. Sarwan Kumar
Chaudhary Gurmukh Chand and Shrimati Gyanvati Kinra Scholarship	Ayush Dwivedi (BT/ME)	Dr. Vikram K Kinra
M.M. Hasan Memorial Scholarship	Ahmad Akhtar (BT/EE)	Family & Friends of Prof. M. M Hasan

Mahabala- Rajaraman Scholarship	Ansh Agarwal (BT/CSE)	Mr. Ashok Shah
Mehesh and Sashi Chandra Scholarship	Apurva Pratap Singh (BS/MTH)	Mr. Manish Chandra
Mathur Brothers Scholarship	Anand (BT/CE)	Mr. Atul K. Mathur
Mona and Paramjit Singh Scholarship	Eeshwari J Sunkersett (BT/BSBE)	Mr. Ajit Gill
Mona and Paramjit Singh Scholarship	Madhu Varshini N (BT/BSBE)	Mr. Ajit Gill
Neeraj Kapoor Memorial Scholarship	Rajeev Kumar (BT/CSE)	Mrs. Chhaya Rani Kapoor
Neta Ji Balwansingh Scholarship	Parnapalli Sarath Kumar (BS/STAT)	Late Dr. Ranjit Singh
Neta Ji Balwansingh Scholarship	Havi Bohra (BS/MTH)	Late Dr. Ranjit Singh
Nirmala and Ashok Keshri Scholarship	Sumit Saurabh (BT/ME)	Mr. Piyush Keshri
Nita Goyal and Ashish Gupta Scholarship	Umang Garg (BT/CHE)	Ms Nita Goel
Nita Goyal and Ashish Gupta Scholarship	Tanya Kesharwani (BT/EE)	Ms Nita Goel
Nita Goyal and Ashish Gupta Scholarship	Lali (BT/CE)	Ms Nita Goel
Nita Goyal and Ashish Gupta Scholarship	Riyanshu Kumar (BT/EE)	Ms Nita Goel
Nitish Thakor Scholarship	Priyanshu Pandey (BT/ BSBE)	Mr. Nitish V Thakor
NS Rajaraman Scholarship	Depanshu Sahu (BT/CSE)	Mr. Rajmohan Rajaraman
P.D. Murti Scholarship	Abhishek Kumar (BT/CSE)	Mr. Ram Mohan
P.D. Murti Scholarship	Jagdale Aditya sanjay (BT/CSE)	Mr. Ram Mohan
P.D. Murti Scholarship	Rishikesh Sahil (BT/CSE)	Mr. Ram Mohan
Prof. CNR Rao Science Talent Scholarship	Paras (BS/CHM)	Prof. C.N.R. Rao
Prof. Girdhar Gopal Shukla Memorial Scholarship	Ankita Singh (M.Sc/Stat)	Mr. Ashish Shukla
Prof. Girdhar Gopal Shukla Memorial Scholarship	Madhav Madhukar (M.Sc/STAT)	Mr. Ashish Shukla
Protima Ghosh Memorial Scholarship	Goutam Das (BT/CSE)	Mr. Ranodeb Roy
PSB Prasad Memorial Scholarship	Ravi Kant (M.Sc/PHY)	Ms. Rekha Rani Prasad
Pushpa Garg Scholarship	Maibaram Brajamani Singh (BS/PHY)	Mrs. Ewa and Atul Garg
Rajnath Singh Scholarship	Deven Anand Joshi (BT/ME)	
Ram Rajendra Malhotra Education Society Scholarship	Subhajit Khan (BS/PHY)	M/S. Ram Malhotra
Ram Rajendra Malhotra Education Society Scholarship	Pankaj Khoriya (BT/ME)	M/S. Ram Malhotra

Ram Rajendra Malhotra Education Society Scholarship	Ujjawal Raj (BT/MSE)	M/S. Ram Malhotra
Ramesh Chandra Yadav Scholarship	Rinzee Tamang (M.Sc/CHM)	Late Dr. Ranjit Singh
Ramesh Chandra Yadav Scholarship	Rayyan Ahmad Khan (M.Sc/STAT)	Late Dr. Ranjit Singh
Romesh Chandra Memorial Scholarship	Talin Gupta (BT/CSE)	Mr. Tushar Chandra
S.C. Mehrotra Scholarship	Chandra Vardhan Gottapu (BT/CE)	Mr. Subhash Chand Mehrotra
Sandeep and Vinita Agarwal Scholarship	Priyanshu (BT/CHE)	Mr. Sandeep Agarwal
Sarpanch Salik Ram Katuyar Scholarship	Yash Upadhyay (BT/CHE)	Late Dr. Ranjit Singh
Sarpanch Salik Ram Katuyar Scholarship	Naman Goyal (BT/CHE)	Late Dr. Ranjit Singh
Seema Jain Memorial Jain Scholarship	Samya Raj (M.Sc/CHM)	Prof. Sudhir K Jain
Sengupta Grant Scholarship	Adarsh Kumar Pandey (MT/CE)	Mr. Swapan Sengupta
Shanti and Ramkishore Sahai Saxena Memorial Scholarship	Arnav Gupta (BT/CSE)	Mr. Ashok Saxena
Shanti Devi and Onkar Nath Maewal Scholarship	Aditi Khandelvia (BT/CSE)	Mr. Akhilesh Maewal
Shiv Kumari Shukla Scholarship	Anshu Yadav (BT/CSE)	Mr. Devendra Shukla
Shiv Prakash and Dayawanti Sharma Memorial Scholarship	Ravi Patel (BT/ME)	Mr. Satish Sharma
Shri Bihari Lal Srivastava and Smt. Nalini Srivastava Memorial Scholarship	Paras Sikarwar (BT/CSE)	Mr. Chandra Mohan Srivastava
Shri D.P. Shukla Scholarship	Shubham Kumar (BT/AE)	Mr. Devendra Shukla
Shri Ranbir and Shrimati Mahadevi Chauhan Scholarship	Rahul Buraniya (BS/ECO)	Mr. Satya P Chauhan
Shri Shanker Lal and Shrimati Prema Devi Agarwal Memorial Scholarship	Tanishq Maheshwari (BT/CSE)	Mr. Sharwan Kumar Agarwal
Shrimati Bhagwati Rameshwar Goyal Scholarship	Anu (Dual/BSBE)	Mr. Ashok Kumar Goyal
Shrimati Madhuri Dubey Scholarship	Soumen Giri (M.Sc/CHM)	Mr. Ajay Dubey
Shrimati Madhuri Dubey Scholarship	Debargha Som (M.Sc/ECO)	Mr. Ajay Dubey
Shrimati Vidyawati Dubey Scholarship	Shahid Ahmad (M.Sc)	Mr. Ajay Dubey
Simran Mandeep Kainth Memorial Scholarship	N Ramtej (BT/AE)	Dr. G.S. Kainth
Smt. Dharm Vati Garg Scholarship	Talin Gupta (BT/CSE)	Mr. Avinash Agarwal
Smt. Durga Devi Memorial Scholarship	Athena Paul (M.Sc/CHM)	Dr. S.K. Dogra

Smt. Jagat Kaur Memorial Scholarship	Humayun Ahmad (BT/ME)	Mr. Rajiv Singh
Smt. Neela Dutt Scholarship	Bandaru Venkata Sritan (BT/EE)	Mr. Saibal Dutt
Smt. Padmavathy and Prof. R. Shankar Scholarship	Pritam Maity (M.Sc/CHM)	Mr. Sri Ram Sankar
Smt. Saraswati Singh Scholarship	Rishi Jaiswal (BT/EE)	Mr. Manoj Kumar Singh
Smt. Shyam Lal Garg Scholarship	Manasvi Yadav (BT/CE)	Mr. Ashutosh Garg
Shree Anand Swaroop Garg Scholarship	Aniket Shinde (Dual/AE)	Mr. Ashutosh Garg
Smt. Shanti Devi Garg Scholarship	Manvi Verma (BT/EE)	Mr. Ashutosh Garg
Shree Ramjee Lal Garg Scholarship	Saurabh Yadav (BT/CHE)	Mr. Ashutosh Garg
Sri Kalp Nath Singh Scholarship	Vedansh Pandey (BT/ME)	Mr. Manoj Kumar Singh
Sri R & R Chari Scholarship	Maurya Aryan Swaminath (BT/CSE)	Mr. Rangarajan Vellamore
Sri Singhasan Singh Scholarship	Prakhar Upadhyay (BT/EE)	Mr. Manoj Kumar Singh
Sri Temasek IIT Scholarship	Akshat Jain (BT/CHE)	Dr. Murali Damodaran
Late Srikant Mishra Scholarship	Asif (M.Sc/PHY)	Dr. Sobi Pandey
Sudarshan Kasturia Memorial Scholarship	Akula Venkatesh (BT/CSE)	Mr. Sanjay Kasturia
Swami Sivananda Memorial Scholarship	Dushyant (BT/AE)	M/S. Divine Life Society
Swami Sivananda Memorial Scholarship	Aamir Ahmad (BT/EE)	M/S. Divine Life Society
Swami Sivananda Memorial Scholarship	Devank Saran Prajapati (BT/EE)	M/S. Divine Life Society
Swami Sivananda Memorial Scholarship	Soham Sen (Dual/AE)	M/S. Divine Life Society
Tapan Kumar and Sapna Bandyopadhyay Scholarship	Aman Maloo (BT/EE)	Mr. Subhajyoti Bandyopadhyay
Tarun Sondhi Memorial Scholarship	Mayank Jhunjunwala (BT/ME)	Mr. Vipin Sondhi
Vasudeo Laxman Sahasrabuddhe Vaidya Scholarship	Harshit Gupta (BT/CE)	Prof.Sahasrabuddhe
Vasudeo Laxman Sahasrabuddhe Vaidya Scholarship	Pankajh Jhamtani (BS/STAT)	Prof.Sahasrabuddhe
Vimal Madan Memorial Scholarship	Kshitiz Tyagi (BT/BSBE)	Ms. Suarhaa Monica Banerjee
Vinay Kumar Kapoor and Smt. Sudha Kapoor Memorial Scholarship	Patel Rhut Dipakbhai (BS/ECO)	Mr. Arun Kumar Kapoor
Yashoda Yadav Scholarship	Harshika Agarwal (BT/EE)	Late Dr. Ranjit Singh
Yashoda Yadav Scholarship	Chirag Goyal (BS/MTH)	Late Dr. Ranjit Singh
Class of 1968 Scholarship	Sandeep Kumar (BT/EE)	Batch of 1968

Class of 1968 Scholarship	Susmita Rani (BS/STAT)	Batch of 1968
Class of 1968 Scholarship	Harsh Dixit (BT/MSE)	Batch of 1968
Class of 1968 Scholarship	Banoth Anand (BS/MTH)	Batch of 1968
Class of 1968 Scholarship	Vishal Kumar (BT/CSE)	Batch of 1968
Class of 1968 Scholarship	Guguloth Lokesh (BS/MTH)	Batch of 1968
Class of 1968 Scholarship	Banavath Surya Vardhan (BT/CHE)	Batch of 1968
Class of 1968 Scholarship	Chandra Shekar Lavdyavath (BT/ME)	Batch of 1968
Class of 1968 Scholarship	Navin Patel (BS/ES)	Batch of 1968
Class of 1968 Scholarship	Nishant Singh (BT/CE)	Batch of 1968
Class of 1968 Scholarship	Deepavath Raghu Ram Naik (BT/ME)	Batch of 1968
Class of 1968 Scholarship	Vivek Goel (BT/EE)	Batch of 1968
Neelam and Anil Singh Scholarship	Mayur Dilip Pachpute (BT/CHE)	Mr. Atul Singh
Prof. Sanjeev K. Aggarwal Scholarship	Abhishek Sardar (BT/CSE)	Mr. Ananda Rajagopal
Prof. Sanjeev K. Aggarwal Scholarship	Rahul Meena (BT/CSE)	Mr. Ananda Rajagopal
Mrs. Ratna Kaushik and Dr. Bhoosan Lal Scholarship	Atul Kumar Bhongade (BT/EE)	Mrs. Bhooshan Lal
Sri Ram Sahai Agarwal Scholarship	Anishka Raj (BT/ME)	Mr. Alok Agarwal
Smt. Vidyawati Agarwal Scholarship	Akash Guru (BT/BSBE)	Mr. Alok Agarwal
Tara Ghate's Scholarship	Archit Kumar Gupta (BS/ECO)	Mr. Alok Agarwal
Class of 1990 Scholarship	Vaidik (BT/CSE)	Class of 1990
Class of 1990 Scholarship	Ankit Kumar Jha (BT/CSE)	Class of 1990
Class of 1990 Scholarship	Krishna Agarwal (BT/CSE)	Class of 1990
Class of 1990 Scholarship	Sreeja Srinivasan (BT/CSE)	Class of 1990
B P Srivastava Scholarship	Sourabh Potidar (M.Sc/CHM)	Dr. Ramesh Chandra Srivastava
Director's Scholarship	Mayukh Chowdhury (BT/CSE)	Mr. Lokvir Kapoor
Director's Scholarship	Muthavarapu Anoop (BT/CSE)	Mr. Lokvir Kapoor
Director's Scholarship	Abubakar Siddique (BT/CSE)	Mr. Lokvir Kapoor
Director's Scholarship	Kasavajjala Sai Shreyas (BT/CSE)	Mr. Lokvir Kapoor
Director's Scholarship	Palagiri Sathish Reddy (BT/CSE)	Mr. Lokvir Kapoor
Director's Scholarship	Gade V S S R K Tejas Reddy (BT/CSE)	Mr. Lokvir Kapoor

Director's Scholarship	Archit Agarwal (BT/CSE)	Mr. Lokvir Kapoor
Director's Scholarship	Saurya Singh (BT/CSE)	Mr. Lokvir Kapoor
Smt. Sroja Krishnan Scholarship	Monika Kumar (BT/CE)	Prof. Kannan Krishnan
Smt. Sroja Krishnan Scholarship	Mansi Singh (BT/CSE)	Prof. Kannan Krishnan
Combined Scholarship Scheme For UG Students	Mudit Srivastava (BT/EE)	Mr. Anurag Goel, Mr. Vasandani, Mr. Agarwal, Mr. Gupta, Mr. Randeep Bhasin
Combined Scholarship Scheme For UG Students	Himanshu Kumar (BT/CE)	
Gyanvati and Kamta Prasad Memorial Scholarship	Non Found Suitable	Mr. Hemant Gupta
R.K. Gupta Scholarship	Kalika (BT/CSE)	Mr. R K Gupta
Dr. M.A. Pai Undergraduate Scholarship	Harsh Sarawagi (BT/EE)	Mr. Vijay Vittal
Dr. Rajendra Rathore Memorial Scholarship	Debasis Mandal (M.Sc/CHM)	Mrs. Rajni Nigam
Ravi and Rohini Sakhuja MCM Scholarship	Ayush Bhaghel (BT/ME)	Mr. Ravinder Kumar Sakhuja
Ravi and Rohini Sakhuja MCM Scholarship	Niraj Shukla (BT/ME)	Mr. Ravinder Kumar Sakhuja
Ravi and Rohini Sakhuja MCM Scholarship	Karan Kumar (BT/ME)	Mr. Ravinder Kumar Sakhuja
Ravi and Rohini Sakhuja MCM Scholarship	S Nikhilesh (BT/ME)	Mr. Ravinder Kumar Sakhuja
Ravi and Rohini Sakhuja Project Scholarship	Non Found Suitable	Mr. Ravinder Kumar Sakhuja
Class of 1973 Merit Cum Means Scholarship	Kawaljeet Singh (BT/CSE)	Class of 1973
Class of 1973 Merit Cum Means Scholarship	Ayush Agarwal (Dual/AE)	Class of 1973
Class of 1973 Merit Cum Means Scholarship	Satmeet Singh Saluja (BS/ECO)	Class of 1973
Class of 1973 Merit Cum Means Scholarship	Devdhar U Patil (BS/ECO)	Class of 1973
Class of 1973 Merit Cum Means Scholarship	Amipriya Anand (BT/CE)	Class of 1973
Class of 1973 Merit Cum Means Scholarship	Chirayush Mohanty (BT/CSE)	Class of 1973
Shobha Memorial Scholarship	Sneh Omer (BT/CHE)	Prof. Ashok K Jain
Bhawani Shankar Meena Memorial Scholarship	Anurag Sharma (BT/CE)	2000 Batch
Shri Nathmal Kanodia Memorial Scholarship	Mantavya Upadhyay (BT/EE)	Mr. Mayank Kanodia
Satish and Kamlesh Agarwal Scholarship, Houston, Texas, USA	Uday Kumar Kushwaha (BT/EE)	Mr. Satish Agarwal
Batch of 1965 Scholarship	Prapti Himanshu Dagli (BT/CSE)	Batch of 1965

Batch of 1965 Scholarship	Gokavarapu V V S S Manikanta (BT/CSE)	Batch of 1965
Batch of 1965 Scholarship	Aritra Ambudh Dutta (BT/CSE)	Batch of 1965
Batch of 1965 Scholarship	Harshit Tripathi (BT/ME)	Batch of 1965
The Pawan Tewari Goldman Sachs Scholarship	Prerna Singh Chauhan (BT/CHE)	Mr. Pawan Tewari
The Pawan Tewari Goldman Sachs Scholarship	Lakshmi Kumari (BS/ECO)	Mr. Pawan Tewari
The Pawan Tewari Goldman Sachs Scholarship	Smruti Pramita Sahoo (BT/EE)	Mr. Pawan Tewari
The Pawan Tewari Goldman Sachs Scholarship	Thallapally Meghana (BT/CE)	Mr. Pawan Tewari
The Pawan Tewari Goldman Sachs Scholarship	Ruchika Raj (BT/EE)	Mr. Pawan Tewari
The Pawan Tewari Goldman Sachs Scholarship	Shristy Kishor (BT/MSE)	Mr. Pawan Tewari
The Pawan Tewari Goldman Sachs Scholarship	Tanya Singh (BT/CHE)	Mr. Pawan Tewari
The Pawan Tewari Goldman Sachs Scholarship	Karan Kumar (BT/ME)	Mr. Pawan Tewari
Madan Mohan Singhal Memorial Scholarship	Ankit Khandelwal (Dual/EE)	Arun Singhal
Mallampati Bala Kishore Memorial Scholarship	Om Ji Gupta (BT/EE)	Dr. Virajith Jalaparti
Bachi Devi Rawat Memorial Scholarship	Abhinav Mittal (BT/EE)	Dr. Shishpal S. Rawat
Kedar Singh Rawat Memorial Scholarship	Divyansh Chhabria (BT/CSE)	Dr. Shishpal S. Rawat
Smt. Savitri Devi Memorial Scholarship	Garima (BS/MTH)	Mr. Sudhir Mittal
Shri Mohan Shetye Excellence Scholarship	Nikhil Soni (BT/ME)	Dr. Tara Shetye Behrend
Kashinath Jagdish Prashad Shakuntala Mittal Memorial Scholarship	Raj (BT/ME)	Mr. Pradeep Kumar Mittal
Kashinath Jagdish Prashad Shakuntala Mittal Memorial Scholarship	Sanchit Arora (BS/ECO)	Mr. Pradeep Kumar Mittal
Kashinath Jagdish Prashad Shakuntala Mittal Memorial Scholarship	Bramhapurikar Chaitanya Vishwas (BT/CSE)	Mr. Pradeep Kumar Mittal
Kashinath Jagdish Prashad Shakuntala Mittal Memorial Scholarship	Ankit Kumar Dubey (BS/ECO)	Mr. Pradeep Kumar Mittal
Karandikar Student Scholarship	Kuldeep Dhar Dwivedi (BT/EE)	Mr. Ashish Karandikar
Dilip Nigam Memorial Scholarship	Manish Kajla (BS/MTH)	Ms. Seema Srivastava

Satish and Kamlesh Agarwal Electrical Engineering Scholarship, Houston, TX, USA	Shobhit Sharma (BT/EE)	Mr. Satish Agarwal
Satish and Kamlesh Agarwal Electrical Engineering Scholarship, Houston, TX, USA	Tanmay Soni (BT/EE)	Mr. Satish Agarwal
Satish and Kamlesh Agarwal Electrical Engineering Scholarship, Houston, TX, USA	Jagtap Arnav Anil (BT/EE)	Mr. Satish Agarwal
Satish and Kamlesh Agarwal Electrical Engineering Scholarship, Houston, TX, USA	Nishant Patel (BT/EE)	Mr. Satish Agarwal
Satish and Kamlesh Agarwal Computer Science and Engineering Scholarship, Houston, TX, USA	Pathe Nevish Ashok (BT/CSE)	Mr. Satish Agarwal
Manas Mandal Student Scholarship	Abhishek Khandelwal (BT/CSE)	Dr. Manas Mandal
Prem Jain Award For Excellence in Sustainability	Soham Goswami (PhD/ME)	Ms. Payal Jain
Pritam Lal Shakuntala Rawal Memorial Scholarship	Saket Kumar (BT/EE)	Mr. Rakesh Rawal
Pritam Lal Shakuntala Rawal Memorial Scholarship	Ishika Gupta (BT/MSE)	Mr. Rakesh Rawal
Pritam Lal Shakuntala Rawal Memorial Scholarship	Mayank Raj (BT/CE)	Mr. Rakesh Rawal
Pritam Lal Shakuntala Rawal Memorial Scholarship	Ritendra Kumar (BT/CE)	Mr. Rakesh Rawal
Pritam Lal Shakuntala Rawal Memorial Scholarship	Prakhar (BT/CE)	Mr. Rakesh Rawal
Pritam Lal Shakuntala Rawal Memorial Scholarship	Deshmukh Pradyumna Prashant (BT/ME)	Mr. Rakesh Rawal
Pritam Lal Shakuntala Rawal Memorial Scholarship	Kartik Raj (BT/ME)	Mr. Rakesh Rawal
Pritam Lal Shakuntala Rawal Memorial Scholarship	Rohit Vijaykumar Somani (BT/CSE)	Mr. Rakesh Rawal
Pritam Lal Shakuntala Rawal Memorial Scholarship	Yashaswi Raj (BT/CSE)	Mr. Rakesh Rawal
Pritam Lal Shakuntala Rawal Memorial Scholarship	Rishabh Yadav (BT/STAT)	Mr. Rakesh Rawal
Pritam Lal Shakuntala Rawal Memorial Scholarship	Ayush Gautam (BT/EE)	Mr. Rakesh Rawal
Sqn. Ldr. Sudhanshu Mohan Scholarship	Shrasti Dwivedi (BS/STAT)	Dr. Chandra Mauli Agrawal
Late Sri Arun Kumar Sinha Scholarship	Harshit Pandey (BT/CE)	Mr. Ashish Kumar Sinha
Late Dr. Chandra Mohan Singhal Scholarship	Jatin Toshniwal (BT/CSE)	Mr. Prakash Mohan
Lakshmi Hayagrivam Scholarship	Manan Jain (BS/ECO)	Mr. Srikant Ranganathan

Dr. T B Singh Scholarship	Chandradip Karmakar (BT/CSE)	Mr. Manoj Singh
Amitabh and Richa Srivastava Scholarship	Payal Dangi (BT/EE)	Mr. Amitabh Srivastava
Jagdish Chander Khanna Scholarship	Palagiri Satish Reddy (BT/CSE)	Mr. Gautam Khanna
Kaira Karmakar Memorial Scholarship Program	Sahil Agarwal (BT/CSE)	Mr. Kamal Karmakar
Kaira Karmakar Memorial Scholarship Program	Dhruv Jain (BS/MTH)	Mr. Kamal Karmakar
Kaira Karmakar Memorial Scholarship Program	Duvvuri Jyothi Samanvith (BT/CSE)	Mr. Kamal Karmakar
Kaira Karmakar Memorial Scholarship Program	Deepak Kumar (BT/CSE)	Mr. Kamal Karmakar
Vishesh Panjabi Memorial Scholarship	Ved Prakash Vishwakarma (BT/EE)	Family and Friends

Program Name	Name	Department	Program
YUVA Scholarship	Ashish Sharma	ME	B.Tech
	Saurabh Kumar	MATH	BS
	Deepak Bharti	EE	B.Tech
	Dinesh Kumar	CE	
	Anuj Singh	PHY	BS
	Azad Bharti Ahirwar	ME	B.Tech
	Gunjan	AE	
	Rishitesh Keshri	CSE	
	Gourav Singh Chouhan	CHE	
	Manish Kumar Meena	MATH	BS
	Vishal Bhaskar	ME	B.Tech
	Manish Gurjar	CE	
	Krishna Soni	MSE	
	Jithin J Joshi	EE	
	Sneha	EE	
	Velpula Jashwanth	CSE	
	Amgoth Rahul	MSE	
	Suhani Bansal	ME	
	Ishika Gupta	MSE	
	Ayush Mangal	CSE	
Anhishek	CHE		

YUVA Scholarship	Shikhar Gupta	MATH	BS
	Sejal Gupta	MSC	B.Tech
	Mayank Kumar	CHE	B.Tech
	Abhay Kesarwani	BSBE	B.Tech
	Aman Srivastava	CSE	B.Tech
	Tamanna Kumari Mahato	ME	B.Tech
	Brijesh Patel	CE	B.Tech
	Duvvuri Jyothi Samanvith	CSE	B.Tech
	Amlan Priyadarshi	CE	B.Tech
	Varun Agrawal	MSE	B.Tech
	Poonam Gupta	CHE	B.Tech
	Sujal satish Motagi	CSE	B.Tech
	Krish Agrawal	CHE	B.Tech
	Chhaya	EE	B.Tech
	Jagrav Garg	EE	B.Tech
	Alokik Tewari	CHE	B.Tech
	Diya Gupta	ME	B.Tech
	Aditya Goel	CE	B.Tech
	Chanakya Navghare	CE	B.Tech
	Rachna Sinha	AE	B.Tech
	Ankur Sahu	CE	B.Tech
	Vedant Sachin Lohare	AE	B.Tech
	Nirajkumar Binod Prasad	CSE	B.Tech
	Pradeeep Meena	EE	B.Tech
	Vaibhav Kumar Maurya	BSBE	B.Tech
	Keshav Agarwal	MATH	BS
	Abhinav Mishra	EE	B.Tech
	Ritendra Kumar	CE	B.Tech
	Suryamani	CE	B.Tech
	Abhinav Rai	BSBE	B.Tech
	Ashish Kumar Soni	SDS	B S
	Nishant Singh	CE	B.Tech
	Ravi Kumar	ECO	B S
Divyanshi Agnihotri	BSBE	B.Tech	
Harsha Sharma	CE	B.Tech	
Shilpee Paswan	MTH	B S	
Mayank Baranwal	ME	B.Teh	
Vatsal Kumar	MSE	B.Tech	

YUVA Scholarship	Himavarsha Kotnana	CE	B.Tech
	Shubham Singh	CHE	B.Tech
	Krishna Kumayu	CSE	B.Tech
	Karan Keer	CHE	B.Tech
	Krishna Agrawal	EE	B.Tech
	Vikas Sunda	CHE	B.Tech
	Abhishek Kumar Verma	ECO	B S
	Vuppulam Prajwal	MTH	B S
	Vikas Chauhan	ME	B.Tech
	Tanya Singh	CHE	B.Tech
	Boya Anudeep	BSBE	B.Tech
	Om Gupta	BSBE	B.Tech
	Abhay Singh	CE	B.Tech
	Raghvendra Singh	CE	B.Tech
	Aman Kumar Singh	MSE	B.Tech
	Karanam Guna Sekhar Subbarao	EE	B.Tech
	Kantipudi Sri Aswin	MATH	BS
	Pritam Priyadarshi	ME	B.Tech
	Arbaaz Tanveer	ME	B.Tech
	Aditya Narayan Jha	MSE	B.Tech
	Aamir Ahmad	EE	B.Tech
	Mrityuunjay Kumar	MSE	B.Tech
	Tushar Jain	CHE	B.Tech
	Adabala Ram Haneesh	EE	B.Tech
	Shivraj Shivaji Bakare	MSE	B.Tech
	Vicky Merotha	CE	B.Tech
	Ayush Rajput	MSE	B.Tech
	Nithin T M	CHE	B.Tech
	Harsh Wardhan Singh Shekhawat	ME	B.Tech
	Sushil Regar	MSE	B.Tech
	Tanish Bansal	MATH	BS
	Jeetraj Gupta	CE	B.Tech
	Love Chourasia	CE	B.Tech
	Vineet Manoj Nagrale	ECO	BS
Divyansh Asthana	ES	BS	
Chandra Vardhan Goottapu	CE	B.Tech	
Kanthi Ashwini	EE	B.Tech	

YUVA Scholarship	Purushottam Kumar	CHM	B S
	Vishal Raj	CHE	B.Tech
	Sandeep Kumar Jha	ECO	B S
	Bipin Kumar Jaiswal	CHE	B.Tech
	Talakola Likhitha	EE	B.Tech
	Priyanshu Kumar Chaudhary	CHE	B.Tech
	Monika	ME	B.Tech
	Bhanu Pratap	ECO	B S
	Bandi Aditya	MSE	B.Tech
	Ankit Kumar	CE	B.Tech
	Ankit Kumar	ME	B.Tech
	Vaibhav Kumar	MSE	B.Tech
	Sunny Kumar	CHE	B.Tech
	Sachin Kumar Upadhyay	CE	B.Tech
	Stuti Shukla	CHE	B.Tech
	Shagun	MSE	B.Tech
	Pathak Prince	PHY	B S
	Sunny Kumar	CHE	B.Tech
	Manam Amara Gayathri	CSE	B.Tech
	M Adnan Khan	ES	B S
	Ankit Kumar Dubey	ES	BS
	Divyansh Yadav	ME	B.Tech
	Aryan Chaturvedi	MSE	B.Tech
	Aditya Anand	MTH	B S
	Ashish Porwal	CE	B.Tech
	Snehasish Halder	ES	B S
	Pushpender	MATH	BS
	Vansh Agarwal	CE	B.Tech
	Shraman Foundation	Aadya Umrao	CE
Ajeet Meena		CSE	B.Tech
Anju Kumari		EE	B.Tech
Mohd Riyaz		MSE	B.Tech
Mukesh Nath		ME	B.Tech
Pooja Kumari		MSE	BS
Priyanshu Priyam		CE	B.Tech
Ravi Vaishnav		ES	BS
Ritik Kumar		BSBE	B.Tech
Sakshi Kishore Patil		ES	BS
Saurav Kumar		CE	B.Tech

Shraman Foundation	Surendra Kumar Ahirwar	CSE	B.Tech
	Uday Singh Meena	CH	BS
	Vikash Kumar	CE	B.Tech
	Vishal Singh	CH	BS
	Vishant Bhadana	MSE	B.Tech
	Yuvraj Singh Kharte	ES	BS
	Aman Kashyap	AE	B.Tech
	Amisha Patel	ME	B.Tech
	Anurag Mandal	ES	BS
	Himanshu Yadav	ME	B.Tech
	Kaushalendra Singh	CHE	B.Tech
	Nikita	ME	B.Tech
	Preeti Meena	MSE	B.Tech
	Rohit Karwa	MATH	BS
	Anil Meghwal	CE	B.Tech
	Myathari Samson	PHY	BS
	Pallavi Anil Undre	AE	B.Tech
	Swati Patel	MSE	B.Tech
	Ayush Sahu	CHE	BS
	Fwilao Basumatary	BSBE	B.Tech
Karan	CHE	BS	
Mrityunjay Kumar	MSE	B.Tech	

S.No	Scholarship Name	Name	Prog.
1	Pritam Lal Shakuntala Rawal Memorial Scholarship	Naveen Ola	(BT/ME)
2	Kaira Karmakar Memorial Scholarship Program	Inesh Aggarwal	(BT/CSE)
3	Combined Scholarship Scheme For UG Students	Bhagavatula Sri Sai Siva Aditya	(BS/ECO)
4	Combined Scholarship Scheme For UG Students	Krish Mesariya	(BT/CSE)
5	Combined Scholarship Scheme For UG Students	Muragesh Channappa Nyamagoud	(BT/CE)
6	Combined Scholarship Scheme For UG Students	Shlok Sharma	(BT/CHE)
7	Combined Scholarship Scheme For UG Students	Sujal Satish Motagi	(BT/CSE)
8	Combined Scholarship Scheme For UG Students	Yash Dabi	(BT/CSE)
9	Sandeep And Shruti Gupta Talent Scholarship	Vanshika Khandelwal	(BT/EE)
10	Mrs. Nirmal Kumari Gaur Scholarship	Gorika Singhal	(BT/AE)

11	V Srinivasan Memorial Scholaship	Navnit Patel	(BT/ME)
12	V Srinivasan Memorial Scholaship	Pushpdeep Teotia	(BT/ME)
13	Dharamshi Family Scholarship	Aayushman Tripathi	(BT/MSE)
14	Acc Fellowship	Abhishek Maurya	(M.Sc/CHM)
15	Acc Fellowship	Sudarshana Karmakar	(Dual/CHM)
16	Skylark Award	Saumya Kumari	(BT/CHE)
17	Class Of 1968 Creative Research Proposal Prize	Md Rahbar	(BT/CE)
18	Class Of 1968 Creative Research Proposal Prize	Hera Fatma	(MT/BSBE)
19	Arish Ali Scholarship	Saksham Gupta	(Dual/EE)
20	Gopal Lakhani Leadership Award For Sporting Event Organization	Navdeep	(BT/CHE)
21	Gopal Lakhani Leadership Award For Professional Development Activities	Abhijit Dalai	(BT/CHE)
22	Gopal Lakhani Leadership Award For Professional Development Activities	Suryansh Rastogi	(BT/AE)
23	Gopal Lakhani Leadership Award For Community Services	Pratham Sharma	(BT/CE)
24	Bright Minds Scholarship Program	None Found Suitable	
25	Jeet Bindra Scholarship For Female Students		
26	Trilok Chandra Mittal Memorial Scholarship		
27	Smt. Kusum Singh Scholarship		
28	Gyanvati And Kamta Prasad Memorial Scholarship		
29	"Airbus-lit Flying Start Programme (2 Nos.)"		
30	Aviation Development Awards		
31	Lalit Kishore Chaudhary Memorial Scholarship		
32	Sagnik Asis Ray Scholarship		
33	Steel Scholarship		
34	Sy Jakatdar Scholarship		

ACADEMIC EXCELLENCE

S.No	Program Name	Donor Name	Recipient Name	Program	Department
1	Ajay Agarwal Memorial Prize	Mr. R. C Agarwal	Rohan Batra	Btech	CHE
2	Dr. V. Rajaraman Scholarship	Mr. Prabhu Goel	Talin Gupta	Btech	CSE
3	O.P Bajaj Memorial Award	Mrs. Saroj Bajaj	Devan Anand Joshi	Btech	ME
4	Sridhar Memorial prize	Mr. G.C. Srivastava	Hamza Masood	Btech	EE
5	Swastika Dwivedi Gargi Award	Mr. Kamlesh Dwivedi	Anushree Chaudhary	Btech	EE
6	Kritika Dwivedi Maitreyi Award	Mr. Kamlesh Dwivedi	Apoorva Gupta	Btech	CSE
7	Anamika Dwivedi Lilavati Award	Mr. Kamlesh Dwivedi	Geetika	Btech	CSE
8	P. K. Subbulakshmi Memorial Award	Prof. K. A. Padmanabhan	Lakshmi Dinesh	Mtech	MSE
9	Dr. Sangeeta Goel Memorial Award	Mr. Bimal Prakash Agarwal	Sreeja Srinivasan	Btech	CSE
10	Dr. R.C. Srivastava Memorial Scholarship	Dr. Sheela Srivastava (Himalaya Institute Hospital Trust)	Dhruv Aggarwal	MSC	STA
11	N. Balakrishnan Award in Statistics	Dr. N. Balakrishnan	Swapnonil Mondal	M.SC	STA
12	J.N. Kapur Prize	Dr Uma Kumar	Urjasween Chakraborty	MSC	MTH
	J.N. Kapur Prize	Dr Uma Kumar	Vihaan Sapra	Btech	CSE
13	MAY Award for Engineering Excellence	Mr. Satyajeet Ghosh	Aman Kumar Singh	Dual	CE
	MAY Award for Engineering Excellence	Mr. Satyajeet Ghosh	Saurabh Gupta	P.hd	CE
14	Amit Saxena Memorial Award	K B Saxena	Shobhit Sharma	Btech	EE

INFRASTRUCTURE INITIATIVES

IIT Kanpur continues to enhance its infrastructure through forward-looking initiatives that integrate technology, sustainability, and interdisciplinary innovation. The institute is developing state-of-the-art facilities to advance research, healthcare, and education, underscoring its commitment to building a modern, inclusive, and progressive nation, and fostering excellence in science, engineering, and societal development.

GANGWAL SCHOOL OF MEDICAL SCIENCES AND TECHNOLOGY



The Gangwal School of Medical Sciences and Technology at IIT Kanpur has made significant progress in the past year, marked by robust donor support, major infrastructure developments, strategic partnerships, and a vibrant calendar of academic and research activities.

The school's foundation and growth are anchored by the generosity of Mr. Rakesh Gangwal, who donated ₹100 crores to establish the medical school at IIT Kanpur. This initiative, formalized through an MoU in April 2022, has transformed the landscape of medical education and research on campus. The school is named in his honor, and the adjoining super-speciality hospital is supported by JK Cement and named after Late Mr. Yadupati Singhania.

The Founder's Circle includes eminent IIT Kanpur alumni and industrialists such as Mr. Muktesh Pant, Dr. Dev Joneja, Mr. Hemant Jalan, and Mr. Anil Bansal, each contributing to the school's vision and endowments. Additional support comes from leaders like Dr. Deepak Narula (Co-founder), Mr. Vikram Tannan, and families such as the Sutwalas and Parikhs, as well as corporate donors like Opalescent IT Solutions Inc.

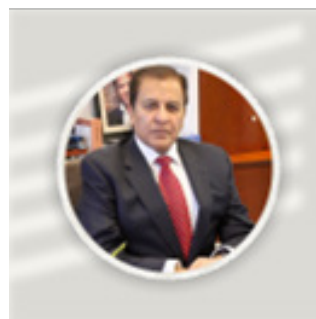

INFRASTRUCTURE MILESTONES

Construction on the GSMST campus and the Yadupati Singhania Super Speciality Hospital has advanced steadily:

- Key construction milestones were achieved throughout the year, such as the approval of the fly-ash mix design, and M/s AGS started mobilization at GSMST and the completion of multiple structural slabs and columns.
- Internal Quality Management System audit
- Block Work Started at P1- First floor



EVENTS AND NEWS

योगी सरकार आईआईटी कानपुर में बनाएगी चिकित्सा संस्थान, नई तबादला नीति को मंजूरी

अजय त्रिवेदी

लखनऊ। उत्तर प्रदेश सरकार आईआईटी कानपुर में चिकित्सा शोध संस्थान के साथ ही सुपर स्पेशलिटी अस्पताल की स्थापना करेगी। प्रदेश सरकार ने खर्चमान राश के लिए तबादला नीति को मंजूरी दे दी है। मंगलवार को मुख्यमंत्री योगी आदित्यनाथ की अध्यक्षता में हुई मंत्रिमंडल की बैठक में यह राश के लिए तबादला नीति सहित कुल 41 प्रस्तावों को मंजूरी दे दी गई है। मंत्रिमंडल के फैसलों को जानकारी देते हुए प्रदेश के विगत एवं संसदीय कार्य मंत्री सुरेश खन्ना ने बताया कि लखनऊ में नया हवाई अड्डा बनाने और सोनभद्र जिले के अंबवा में बस रहे 2 जल विद्युत घा



लेने के प्रस्ताव पर पारित किया है। प्रदेश सरकार इस अंग के लिए वार्षिक बजट में 2025 में होने जा रहे मालाखुंब की बैठकियों को लेकर भी कई प्रस्तावों को मंजूरी दे दी है। इस बार कुल राश 3,200 करोड़ रुपये के अंतर्गत 11,705 करोड़ रुपये से बढ़ाकर 13,005 करोड़ रुपये किया जाने के प्रस्ताव को स्वीकृति दी गई है। कानपुर देहात जिले के घाटमपुर में लय रही नैनेल्ली व उत्तर प्रदेश विद्युत

- The Uttar Pradesh government announced ₹50 crores in funding, to be disbursed over five years, further strengthening the financial foundation for the hospital's construction.
- GSMST was featured in The Week Magazine (June 2024 edition)



- GSMST hosted delegations from the Armed Forces Medical Services and Tata Communications, exploring collaborative opportunities in research and healthcare delivery.
- GSMST hosted the AIRTF selection meeting for the Anusandhan National Research Foundation (ANRF) to create networks and collaborations in STI and cross-sectoral areas.
- A joint online research colloquium was organized on the theme **“Exploring Biological and Chemical Strategies to Combat Antimicrobial Resistance (AMR)”**.



- As part of the Jalan Distinguished Lecture Series in MedTech Innovation, Gangwal School organized a talk by Prof. Muthuraman Muthuraman, University of Augsburg, Germany.



- GSMST organized an exciting talk on **“Understanding Cancers!”** by Dr. Shabnam Bashir, Senior Consultant Breast & Colorectal Cancer Surgeries, Kashmir, under the aegis of Joneja Colloquium Series in Clinical Medicine on August 1st at 4.30 PM. The talk was organized at the Mehta Family Center for Engineering in Medicine at IIT Kanpur.



- IIT Kanpur signed an MoU with the ICICI Foundation to build a Digital Health Stack that will help improve public healthcare using medical technology, AI-based diagnostics, and better point-of-care services.



- IIT Kanpur signed an MoU with IIM Lucknow to offer an academic Postgraduate Joint Degree Program on **“Healthcare Management”** as part of Gangwal Medical Sciences and Technology. The MoU was signed by Prof. Manindra Agrawal, Director IITK and Prof. Archana Shukla, Director, IIM Lucknow. This program will equip students of several disciplines, doctors & medical professionals, with a contemporary blend of business administration with technological healthcare knowledge, positioning them as effective leaders to address complexities of healthcare industry & management.

- As part of the Pant Workshop Series on Medical Technology and Future Medicine, the Gangwal School of Medical Sciences and Technology (GSMST) organized a conference featuring expert discussions on **“Innovative Solutions for Metabolic Health: From Research to Reality.”**



- **The Innovations in NeuroTech Workshop** was organized on November 21, 2024, by Dr. Arjun Ramakrishnan under the aegis of the Center of Excellence in Neuroscience, Neurotechnology, and Mental Health. The workshop provided a valuable platform for interdisciplinary collaboration among experts in clinical neuroscience, computational neuroscience, and neuro-engineering.



- The International Research Symposium on **“Advancements in Precision Healthcare Robotics and Assistive Technology”** was held on November 22–23, 2024.



- SPARC Project Symposium on **“Point-of-Care Healthcare Devices”** and the Pant Workshop Series on **Medical Technology & Future Medicine** were jointly held from November 25–27, 2024. The events featured in-depth discussions on emerging medical technologies, focusing on scalable, patient-centric innovations.



- SPARC Symposium on **India–Australia Cooperation in Medical Education and Biomedical Research** was held on November 29, 2024, at the Melbourne Global Centre, Connaught Place, New Delhi. The event fostered cross-national collaboration and exchange of ideas in medical training and research.



SMST Flagship Projects were prominently showcased during “**IITK Samanvay: Empowering Industry**” held on November 29, 2024, highlighting the School’s ongoing efforts in translating research into impactful industry solutions.

Workshop on “**Promotion of Equitable Access to Affordable Healthcare in Uttar Pradesh**” was conducted on January 28, 2025. The workshop focused on policy, technology, and community-based strategies to ensure inclusive healthcare access across the state.

- In collaboration with the Armed Forces Medical Services, **GSMST organized a 6-day capsule course** for medical cadets from AFMC Pune. The program was designed to provide exposure to advancements in medical technology and interdisciplinary healthcare research.
- Several dignitaries visited the GSMST site, including the Director of IIT Kanpur, Dr. Deepak Mohan Narula, Mr. Arvind Singh, HDFC CSR Head, Shri Awanish Awasthi, Shri Manas Mandal, Prof. Anna Ryan, and Mr. Rakesh Gangwal.

KOTAK SCHOOL OF SUSTAINABILITY

In a landmark initiative supported through Kotak Mahindra Bank’s CSR program, IIT Kanpur established the **Kotak School of Sustainability**—India’s first fully integrated and interdisciplinary school dedicated to sustainability. The school aims to address global and national climate challenges through advanced research, education, and outreach.



Prof. Sachchida Nand Tripathi is the inaugural Dean of Kotak School of Sustainability at IIT Kanpur and a Professor in the Department of Civil Engineering and the Department of Sustainable Energy Engineering.

Department & Centres of the School of Sustainability

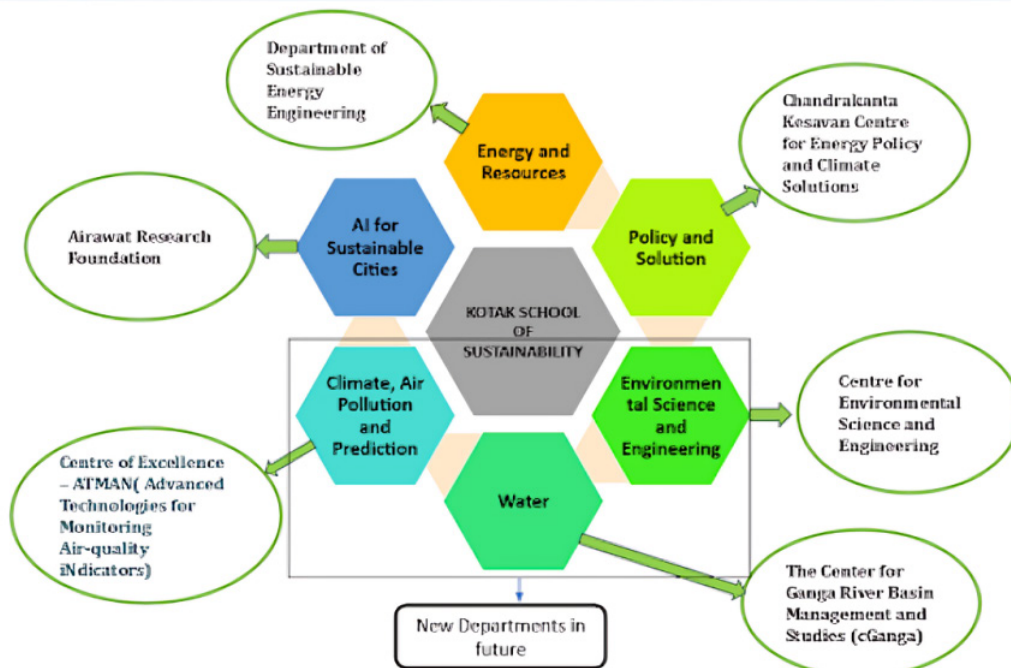

ACADEMIC INTEGRATION

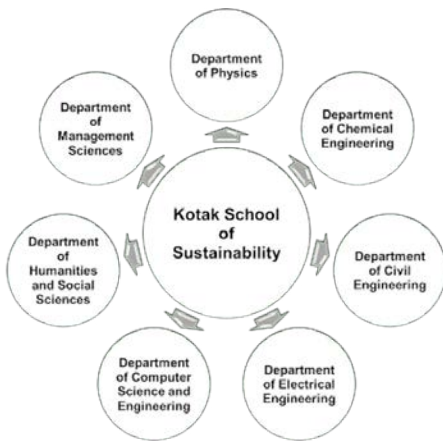

Approved New M. Tech Program on “Artificial Intelligence for Sustainability” under the school: A key milestone is the formal approval and rollout of a new interdisciplinary MTech program in “Artificial Intelligence for Sustainability,” designed to equip students with technical expertise and contextual understanding to apply AI in solving pressing sustainability challenges. The program is supported by diverse departments and offers a comprehensive credit structure combining core courses, labs, electives, and thesis work.

- In addition, the School offers a **PhD program in Artificial Intelligence for Sustainability**, the highest academic degree awarded by the School. This program is ideal for individuals aiming for careers in academia, industry, or government and focuses on a range of key areas, including Climate Change, Resilience and Adaptation, Modeling, Water and Water Resource Engineering, Sustainable Cities, and the intersection of Artificial Intelligence and Sustainability.

COLLABORATIONS

To further its sustainability mission, the School has established partnerships with several leading institutions:

- **HESCO, Dehradun:** Joint efforts on the development of a Sustainability Index and outreach initiatives.
- **Kanpur Smart City Ltd. :** Collaboration on technology development aimed at achieving Net Zero Waste.
- **INSA, New Delhi:** Partnership focused on leveraging IIT Kanpur and INSA’s strengths for advancing science, technology, and innovation (STI) policy.
- **Nanyang Technological University, Singapore:** Collaborative research on novel membrane technologies for water and wastewater treatment.

RESEARCH & INNOVATION

Research efforts under the School include the development of field-deployable, scalable technologies, with pilot testing of low-cost air pollution sensors and membrane filtration units currently underway in Kanpur and Vidisha. As part of Net Zero initiatives, a campus-wide energy audit has been completed, and the implementation of solar PV systems and waste segregation units has been initiated.

OUTREACH EVENTS



- National Conference on Innovative AI Solutions for Sustainable Cities 2025 was held on February 3, 2025.



- IIT Kanpur Swastibhavatu Lecture Series was held on March 25th, 2025. The inaugural lecture was delivered by Padma Shri Prof. Thalappil Pradeep (IIT Madras).



- Workshop on 'Watershed Development under Pradhan Mantri Krishi Sinchayee Yojana (PMKSY)' was held on April 4th 2025.

- A series of KSS Seminars were held, featuring distinguished speakers including Prof. Raghu Murtugudde, Dr. Mukund Rao, Dr. Anil Prakash Joshi, and Prof. Anu Ramaswami.

**CORPORATE
SOCIAL
RESPONSIBILITY
(CSR)**

Corporate Social Responsibility (CSR), as mandated under the Companies Act, 2013 by the Government of India, reflects a structured approach to inclusive and sustainable development. It facilitates active participation of the corporate sector, including Public Sector Undertakings (PSUs), in addressing critical socio-economic and environmental challenges. CSR is not merely a statutory requirement it represents a meaningful commitment to social development. It enables companies and organizations to play an active role in improving the quality of life in communities. At the Indian Institute of Technology Kanpur, CSR initiatives are thoughtfully integrated with the institute's broader vision of contributing to national progress through education, research, and community engagement. By partnering with corporate donors, IIT Kanpur channels CSR support into areas such as rural education, healthcare, environmental sustainability, skill development, and women's empowerment ensuring that the benefits of knowledge and resources extend beyond the campus to reach those who need them most.



FUNDING OPPORTUNITY

Under CSR at IIT Kanpur, partnership opportunities are categorized into key areas such as Student Initiatives, Faculty led Initiatives, Innovation & Entrepreneurship, and Institutional Infrastructure. These include diverse funding options like scholarships, faculty fellowships, research support, lab development, learning spaces, and sports facilities. The framework highlights how CSR contributions can support both academic growth and overall institutional development.

Three main domains have been outlined, highlighting some key areas of funding opportunities. These represent major avenues for CSR support, while several other impactful areas also exist beyond these.



RESEARCH - SUB DOMAINS

HEALTH CARE	Non-Invasive Devices	Med Tech Devices	Preventive Health Care	Diabetes	Cancer
TRANSPORTATION	Road Safety	Rail Safety	Marine Safety	BCI in Wheel Chair	PedaSafe
ENVIRONMENT	EV	Hydrogen- Clean Energy	Waste Management	Disaster Management	Water Management
RESEARCH & INNOVATION	Quantum	Semiconductors	UAV	Robotics & Automation	Metallurgy & 3D Printing
ARTIFICIAL INTELLIGENCE	Health Care	Traffic Management	Ethics	LLM's	Legal System



GSMST - SUB DOMAINS

(8) CENTER OF EXCELLENCE	Telemedicine & Robotics	AI applications in Healthcare	Therapeutics Tropical & Infectious diseases	Non-invasive Imaging and Diagnostics	Cardiovascular Research & Others
(9) CLINICAL DEPARTMENTS	Oncology	Cardiology	Cardiovascular & Thoracic Surgery	Neurology	Nephrology & Others
OPERATION THEATRES	Operation Theatre Complex	Neurology(2)	Gastroenterology(2)	Transplant (2)	Cardiology (2) & Others
OPD'S	OPD Rooms (30)	Endoscopy Facility (4)	Blood Bank	Transplant ICU(2)	Ophthalmology & Others
EQUIPMENTS	CT Scan 256 Slices	MRI Machines (3 Tesla)	Cath Labs	PET CT	



INFRASTRUCTURE - SUB DOMAINS









NEW DEPARTMENT	Design	Cognitive	SPASE	Sustainable Energy Engineering	
NEW CENTERS	Mental Health & Well Being	Space Science & Engineering	Vaccine & Antibody Discovery	Center for Diversity and Inclusivity	ARCAS & Others
LAB UPGRADATION	Mechanical Engineering	Electrical Engineering	Material Science & Engineering	Chemical Engineering	Aerospace Engineering & other UG Labs
CAMPUS UPGRADATION	Convention Center	VH Extention	SAC Extention	Lecture Hall Complex	Central dining hall & Student Center
SPORTS FACILITY	Volley ball	Tennis Wall	Synthetic track	Swimming Pool	Bouldering Wall



CSR PARTNERS

S.No	Donor	Logo	Objective
1	Adani Enterprises Limited		Adani Indology Research Scholarship Program
2	Aeron Systems Pvt. Ltd.		Gangwal School of Medical Sciences and Technology







3	AIA Engineering Ltd.		Construction of New Hall of Residence
4	Alkyl Amines Chemicals Limited		Annual Gift Program
5	AlphaGrep Securities Pvt Ltd.		AlphaGrep Scholarship
6	ANSYS Software Private Limited		Promote education amongst students undergoing Masters program
7	Apollo Heat Exchangers Pvt. Ltd		Class of 1974 Legacy Fund Hall 1 Renovation
8	Audify Tech Private Limited		Gangwal School of Medical Sciences and Technology
9	Bharat Forge Ltd.		Towards Manufacturing IIT Kanpur Inaugural Formula Electric Vehicle
10	Bright 4 Wheel Sales Private Limited		IITK Motorsports
11	Citadel Securities India Markets Private Limited		IITK-Citadel Securities T3i lab
12	Citibank N.A.		Social Innovation Lab (SIL) 3.0

13	Continental Belting Pvt Ltd		Pioneering Research Excellence and Innovation Award
14	CREDEX TECHNOLOGY PRIVATE LIMITED		1999 Batch Fund
15	CSI Engineering Software Pvt. Ltd.		National Information Centre For Earthquake Engineering India
16	Faiveley Transport Rail Technologies India Pvt. Ltd.		Material Safety in Railways and Tankers
17	Fashion Suitings Private Limited		Impacting The Learning Journey Of Rural Students To Bring Societal Transformation For Viksit Bharat
18	Frontier Alloy Steel Ltd		Infrastructural Technology Research & Development
19	HDFC Bank		Gangwal School of Medical Sciences and Technology
20	Hexa Tours And Travels Private Limited		Udghosh
21	Hindon Filters Pvt. Ltd.		Class of 1974 Legacy Fund
22	Humboldt Wedag India Private Limited		Pioneering Research Excellence and Innovation Award
23	IBM India Pvt. Ltd.		Gangwal School of Medical Sciences and Technology

24	ICICI Foundation For Inclusive Growth		Development and Integration of advanced digital health infrastructure for Uttar Pradesh
25	IPM India Wholesale Trading Private Limited		Design, Development & Entrepreneurship Center Of Ranjit Singh Rozi Shiksha Kendra
26	ITC Limited		Toward Moisture Resistant Paper Packaging Solutions
27	J K Cement Ltd.		Gangwal School of Medical Sciences and Technology
28	J. K. Fenner (India) Limited		Eliminating Chloroprene Rubber in Wrapped V-Belts: A Sustainable Shift
29	Khanna and Khanna Limited		Development Of Framework And Methodology To Screen Lubricant
30	Kotak Mahindra Bank Ltd.		Kotak School of Sustainability
31	Logic Fruit Technologies Private Limited		Gangwal School of Medical Sciences and Technology
32	MacDermid Alpha Electronics Solutions India Private Limited		Macdermid Alpha Thermal Reliability Lab

33	My Home Industries Pvt Ltd		Pioneering Research Excellence and Innovation Award
34	My Home Power Consultancy Services Pvt Ltd		Pioneering Research Excellence and Innovation Award
35	Nmtronics (India) Private Limited		NMTronics Center of Excellence for Electronics Manufacturing & Skill Development
36	PN International Pvt. Ltd.		Makerspace project for Facility Upgradation of Imagineering Lab of IITK
37	PNC Infratech Ltd.		Debonding & shear behaviour PSC bridge girders
38	Portescap India Pvt. Ltd.		<ol style="list-style-type: none"> 1. Hemo-Compatible surfaces for left Ventricular Assist Device (LVADs) 2. Continuous Non-Invasive Blood Glucose Monitoring Device 3. Development of an Intelligent Sit-to-Stand (STS) and Mobility Support System for the Elderly 4. Design and Development of a Miniature Rotary Actuator Based on Flexinol SMA 5. Transforming Cardiovascular Care: The Case for Indigenous P-MCSD Development

39	Prachi Leathers Pvt. Ltd		Class 1978 legacy project
40	Pradeep Metals Limited		Class 1978 legacy project
41	Qualtech Consultants Pvt. Ltd.		Solar-Driven Manufacturing with Geomaterials Solar Concentrator
42	Rahman Industries Limited		Antaragni 24
43	Raramuri Technology Pvt. Ltd.		Bhu Parikshak 2.0
44	REC Foundation		Gangwal School of Medical Sciences and Technology
45	Rajasthan State Industrial Development and Investment Corporation Limited (RIICO)		Centre for Excellence for Innovation in Basic Education (STEM) Lab
46	Rimjhim Ispat Ltd.		Towards manufacturing IIT Kanpur's second Formula Electric Vehicle
47	Sahasra Electronics Pvt. Ltd.		1972 Golden Jubilee Legacy Project

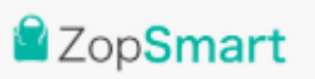
48	Saraswati Heart Care & Research Centre Pvt Ltd		1972 Golden Jubilee Legacy Project
49	Suraj Logistix Pvt. Ltd.		1. Exploring Mineral fillers for Plastic Industry 2. Development of Technology for determination of soil micronutrients
50	Tcs Fellowship		TCS Research Scholar Program
51	Tellapur Technocity Private Limited		Pioneering Research Excellence and Innovation Award
52	Tower Research Capital Markets India Private Limited		Developing AI/ML for India and for the social good
53	TVM Signalling And Transportation Systems Pvt. Ltd.		Campus School Development Initiative
54	ZN Tech Solutions Pvt Ltd		Bhu Parikshak 2.0
55	Zopsmart Technology Pvt. Ltd.		Bhu Parikshak 2.0

CSR DONATION OVERVIEW LAST FIVE YEARS

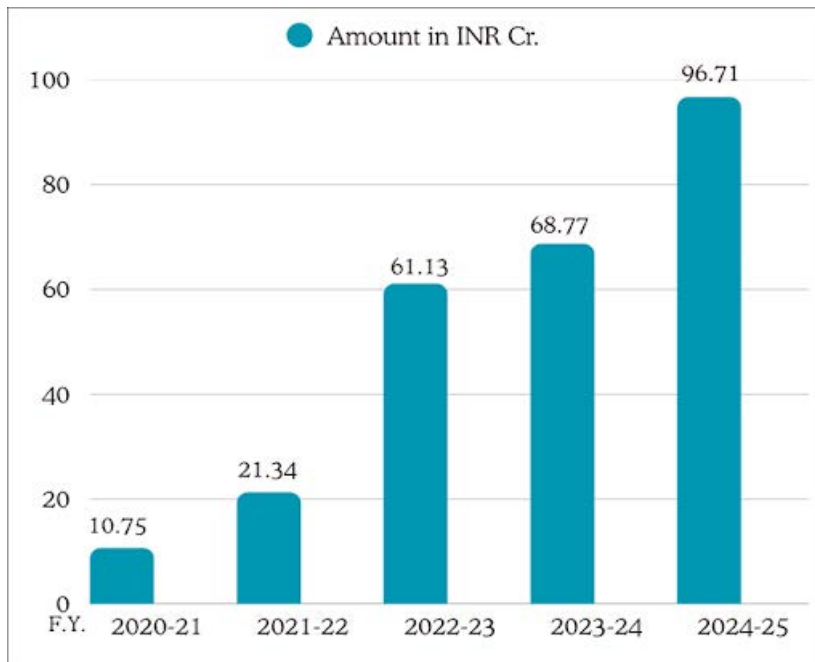

MAJOR DONORS FY 2024-25

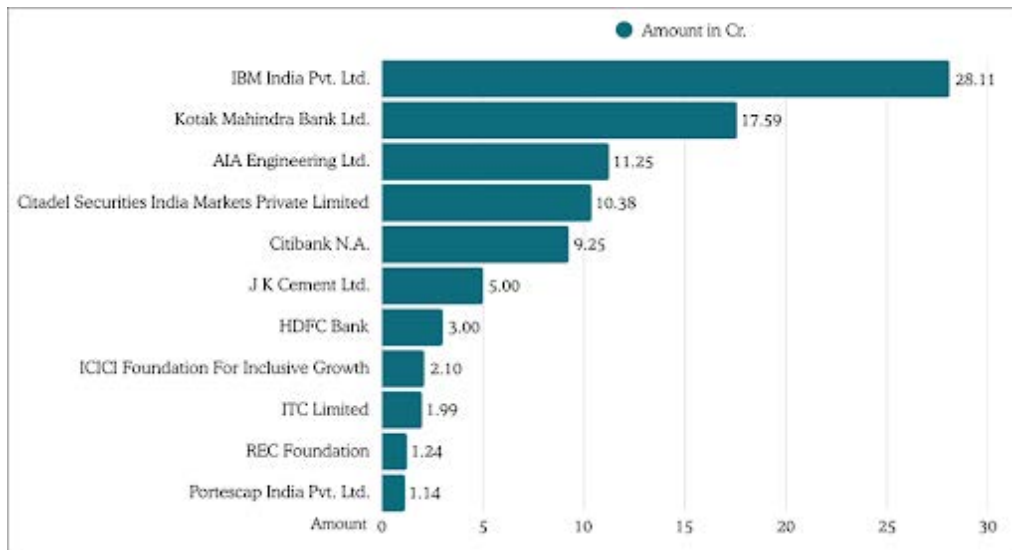

CORPORATE VISITS

Analog Devices (March 2025)

Analog Devices (ADI), a leading US-based semiconductor company, has a strong and growing presence in India. It operates major R&D centers in Bangalore and Hyderabad, supporting global product development. ADI has expanded its workforce significantly, including a 30% growth in its sales and application teams. The company serves key industries such as automotive, industrial, and consumer electronics, and is committed to innovation through customer collaboration to address global challenges.

PNBHFL (January 2025)

PNB Housing Finance Limited, established in 1988 and headquartered in New Delhi, is one of India's leading housing finance companies. Promoted by Punjab National Bank, it offers a comprehensive range

of financial products, including home loans, loans against property, and fixed deposits, catering to both individuals and corporate clients. With a robust pan-India presence through numerous branches and outreach offices, the company is committed to facilitating home ownership across the country.

The company's Corporate Social Responsibility (CSR) initiatives are spearheaded by its dedicated arm, the Pehel Foundation. These initiatives focus on key areas such as education, healthcare, environmental sustainability, and livelihood generation. Notable programs include the 'Digital Shaala' project, aimed at enhancing digital literacy among students, and the deployment of Mobile Medical Units in collaboration with the Wockhardt Foundation to provide primary healthcare services to underserved communities. Additionally, PNB Housing Finance has invested in renewable energy projects and water conservation efforts, reflecting its commitment to sustainable development.

Tower Research Capital Markets (July 2024)

Tower Research Capital Markets Private Limited, the Indian arm of a global quantitative trading firm, is known for its high-performance technology platform and independent trading teams that uncover unique market opportunities. The company is also deeply committed to CSR initiatives in India, focusing on education and community development, with a particular emphasis on technological advancement and empowerment. These efforts reflect Tower's dedication to leveraging its expertise for long-term social impact.

PMI (August 2024)

Philip Morris International's (PMI) India affiliate, IPM India Wholesale Trading Pvt. Ltd., is committed to corporate social responsibility (CSR) initiatives that align with sustainable development goals and community welfare. Operating in India through a joint venture with Godfrey Phillips India Ltd. and K.K. Modi Investment & Financial Services Private Ltd., IPM India focuses on responsible business practices and social impact.

PMI India, through its affiliate IPM India, actively pursues CSR initiatives focused on sustainability and social welfare. Key efforts include adopting energy-efficient logistics with electric and CNG vehicles to reduce carbon emissions, and partnering with ASSIST India to eliminate child labor in tobacco farming by improving education and awareness. The company is also recognized for fostering an inclusive workplace, earning "Great Place to Work" certification for four consecutive years, reflecting its commitment to responsible business and community development.

EVENTS

DoRA OPEN HOUSE

DoRA office at IIT Kanpur recently hosted a successful Open House, offering a deep dive into the growth and evolution of its programs, alumni engagement, and philanthropic efforts and explored how strategic partnerships, increased support, and ongoing contributions are helping shape the future of our institution and strengthen our global community. Dr. Surabhi Yadav, a renowned CSR consultant, led a thought-provoking discussion on **"Making Impact, Driving Change: Academia's CSR Partnership Beyond Compliance"**. With enthusiastic participation from 19 departments and centers across the institute, the event was a resounding success.



IITK SAMANVAY

IITK Samanvay, held on November 29, 2024, at the IIT Kanpur campus, was a landmark initiative aimed at fostering collaboration between industry and academia to drive innovation, progress, and societal impact. Under the theme **“Harnessing innovation for a better tomorrow,”** the event brought together leading industry professionals, academia, and policymakers to explore opportunities for partnership, discuss pressing challenges, and envision transformative solutions. The event featured keynote addresses and engaging panel discussions where participants delved into crucial themes such as the role of corporate social responsibility (CSR) in academic innovation, translational research for industry advancement, and aligning shared goals to create sustainable ecosystems.



MEMORANDUM OF UNDERSTANDING

Under CSR initiatives, IIT Kanpur signed an MoU with the ICICI Foundation for Inclusive Growth to jointly develop the **“UP Digital Health Stack”** aimed at strengthening digital healthcare delivery in Uttar Pradesh. Key components include an LLM-based system to monitor telemedicine interactions for quality assurance, ensuring doctors follow standard treatment guidelines while preserving patient privacy. A gap analysis of point-of-care (PoC) diagnostic devices will identify existing challenges and guide future adoption. Based on this, technical specifications for PoC devices will be developed in line with state health requirements, followed by empirical validation of selected devices using international quality standards to support evidence-based procurement.



IIT Kanpur has signed an MoU with AIA Engineering Limited to construct an environmentally sustainable, advanced hostel facility comprising 500 rooms to accommodate 1,000 students. This initiative aims to ease the pressure on existing housing infrastructure while fostering a safe, inclusive, and academically conducive environment especially for female students. The project is a step towards strengthening the residential experience on campus, encouraging peer learning, and supporting the holistic development of students in line with the institute's mission.



CITADEL | Securities

As part of its broader vision to strengthen computing and AI infrastructure, IIT Kanpur has signed a

MoU with Citadel Securities to establish the **T3i Lab (Translational and Transformative Training and Investigations)**. This initiative aligns with the Department's efforts to enhance research and training in high-performance computing, artificial intelligence, machine learning, and secure systems. The T3i Lab will serve as a critical enabler for translational research and large-scale investigations, reinforcing the department's ability to deliver hands-on education, conduct impactful research, and engage in meaningful industry collaborations.



IIT Kanpur has signed an MoU with CitiBank to launch a renewed Social Innovation Lab program, building on its successful track record of supporting 104 startups across India. The new program will incubate 44 high-impact startups: 35 early-stage and 9 growth-stage focused on Agri-Tech and Clean-Tech innovations. With a strong emphasis on economic and geographical inclusivity, the initiative will target underdeveloped regions across low-income states and the North-East, addressing critical local challenges through technology-driven and scalable solutions. Through financial support, expert mentoring, and deep ecosystem integration, this initiative will empower entrepreneurs to drive sustainable impact and equitable growth across some of the country's most underserved areas.



IIT Kanpur and ITC Limited have joined hands to develop advanced paper-based packaging solutions with enhanced resistance to water vapour ($< 0.2 \text{ g/m}^2/\text{day}$) and oxygen transmission, while ensuring heat seal ability, antimicrobial properties, and machine runnability. The project involves selecting optimal materials and surface treatments, exploring methods like metallization and functional coatings, and incorporating eco-friendly, scalable processes. IIT Kanpur will lead research and development, while ITC will provide industrial feedback and support in key performance testing. Together, the partnership aims to deliver sustainable and industry-ready packaging alternatives

TOP DONORS

Donor Name	Amount in Cr.
IBM India Pvt. Ltd.	28.11
Kotak Mahindra Bank Ltd.	17.59
AIA Engineering Ltd.	11.25
Citadel Securities India Markets Private Limited	10.38
Citibank N.A.	9.25
J K Cement Ltd.	5.00
HDFC Bank	3.00
ICICI Foundation For Inclusive Growth	2.10
ITC Limited	1.99
REC Foundation	1.24
Portescap India Pvt. Ltd.	1.14

Donor Name	Amount in Lakh
Tower Research Capital Markets India Private Limited	61.00
Suraj Logistix Pvt. Ltd.	52.50
Nmtronics (India) Private Limited	49.00
IPM India Wholesale Trading Private Limited	46.47
Tcs Fellowship	39.10
RIICO LTD	22.90
Adani Enterprises Limited	21.00
Khanna and Khanna Limited	20.00
Raramuri Technology Pvt. Ltd.	15.20
MacDermid Alpha Electronics Solutions India Private Limited	15.00
ANSYS Software Private Limited	13.20
Sahasra Electronics Pvt. Ltd.	12.00
Hindon Filters Pvt. Ltd.	11.60
Faiveley Transport Rail Technologies India Pvt. Ltd.	11.55
ZN Tech Solutions Pvt Ltd	11.00
Qualtech Consultants Pvt. Ltd.	10.75

Frontier Alloy Steel Ltd	10.00
Humboldt Wedag India Private Limited	10.00
Pradeep Metals Limited	10.00
Zopsmart Technology Pvt. Ltd.	10.00
CSI Engineering Software Pvt. Ltd.	9.20
Logic Fruit Technologies Private Limited	9.15
CREDEX TECHNOLOGY PRIVATE LIMITED	9.00
Rahman Industries Limited	8.00
Audify Tech Private Limited	7.76
Fashion Suitings Private Limited	6.00
TVM Signalling And Transportation Systems Pvt. Ltd.	5.25
Aeron Systems Pvt. Ltd.	5.00
AlphaGrep Securities Pvt Ltd.	5.00
Apollo Heat Exchangers Pvt. Ltd	5.00
Bharat Forge Ltd.	5.00
Hexa Tours And Travels Private Limited	5.00
PN International Pvt. Ltd.	5.00
PNC Infratech Ltd.	5.00
Prachi Leathers Pvt. Ltd	5.00
Saraswati Heart Care & Research Centre Pvt Ltd	5.00
My Home Industries Pvt Ltd	4.00
Bright 4 Wheel Sales Private Limited	3.00
Tellapur Technocity Private Limited	2.50
Continental Belting Pvt Ltd	2.00
J. K. Fenner (India) Limited	1.54
Rimjhim Ispat Ltd.	1.10
Alkyl Amines Chemicals Limited	0.50
My Home Power Consultancy Services Pvt Ltd	0.25

EDUCATIONAL INITIATIVES

IIT Kanpur is home to several educational institutions such as Kislaya, Campus School, and Opportunity School, which serve not only the children of campus residents but also those from surrounding communities. These schools emphasize experiential learning, focusing on delivering education that's rooted in practical application. The vital financial backing from alumni and other well-wishers plays a key role in sustaining and upgrading these institutions. Their generous support enables access to modern teaching tools and ensures that infrastructure remains conducive to learning. This shared commitment reflects a broader vision to expand quality education beyond the institute's boundaries and nurture an environment where young minds can grow through dynamic teaching practices and enriched learning spaces.

KISLAYA SCHOOL

Kislaya Nursery School, established in 1967 and situated within the IIT Kanpur campus, continues to set benchmarks in pre-primary education, guided by the philosophy of Joyful Learning. The academic session 2024-25 witnessed a steady increase in student strength, which led to the expansion of the teaching staff from 6 to 8 members. This growth reflects the school's ongoing commitment to providing individualized attention and nurturing a culturally rich, developmentally appropriate environment for every child.



INFRASTRUCTURE & ACADEMICS

During the academic year 2024–25, Kislaya Nursery School undertook several infrastructure improvements to enhance comfort and organization. These included the installation of 9 exhaust fans and 13 wall-mounted fans in classrooms to manage summer heat, construction of 2 new storerooms for efficient supply management, renovation of the school office with new tiling, and the addition of a stepwise staircase for the stage based on parent feedback to support student performances.

Academically, the school operated 3 Nursery sections, 2 KG sections, and 2 Prep sections, with a total student strength of 186. All admissions and fee transactions were carried out through cashless systems, ensuring transparency and ease. The dedicated team of eight teachers continued to provide a nurturing environment that combined emotional support, foundational learning, and cultural values, making education a joyful and enriching experience for every child.



SCHOOL ACTIVITIES

Throughout the academic year 2024-25, Kislaya Nursery School organized a vibrant array of hands-on activities designed to nurture creativity, imagination, and essential life skills in our young learners. These activities encouraged exploration, teamwork, and sensory development, making learning both meaningful and joyous. These included collage work, freehand drawing and colouring, origami, clay modelling, diya and candle decoration, and various forms of printing arts such as thumb, vegetable, cotton, and bud printing. Pasting activities using matchsticks, glitter, buttons, paper, and bindis enhanced fine motor skills and attention to detail. Celebratory crafts like Mother's Day card making and rakhi making nurtured emotional expression and cultural awareness. Themed sessions such as the transport activity and storytelling with props enriched conceptual understanding and imagination. Regular poem recitation boosted confidence and language development, while simple science experiments ignited curiosity and a love for discovery. Educational excursions like the zoo trip to Allen Forest Zoo in Kanpur and the Children's Day picnic at Park No. 67 offered experiential learning and social interaction. Festive events such as the Christmas Bounce House Day brought joy and added to the vibrant learning environment.



SPORTS

Sports and physical activities are an essential part of life at Kislaya Nursery School, with every Thursday dedicated to Sports and PT sessions under the guidance of Coach Jay Tripathi. The much-awaited Annual Sports Day, held in November 2024, was a grand celebration of spirit and healthy competition, where every child participated with enthusiasm and joy. Highlights of the year included the March-Past, Mass PT, aerobics, taekwondo, the ever-popular KG football match, and a variety of competitive races such as the balloon race, hurdle race, and even a tug of war for parents. Through these activities, children not only developed coordination, endurance, and physical confidence but also learned the values of discipline, sportsmanship, and teamwork making sports at Kislaya a foundation for healthy habits and joyful learning.



CELEBRATIONS

Celebrating festivals builds cultural awareness and emotional connections. Kislaya believes in experiential learning through stories, costumes, dance, and food.

- Independence Day: Flag hoisting, National Anthem, student performances
- Teacher's Day: Students dressed as their class teachers and shared cards
- Raksha Bandhan: Rakhi making, tying ceremony, and dances
- Janmashtami: Jhanki decoration, Krishna stories, and dance
- Dussehra: Storytelling, Dandiya party, and Ram-Leela
- Diwali: Diya making, paper lanterns, puja, rangoli, firework show
- Christmas: Santa-themed day with bounce house play and gift exchange
- Republic Day: Flag hoisting, performances, and speeches on freedom fighters
- These moments strengthen students' values, their understanding of tradition, and create lifelong memories.



CLASS PARTIES

Kislaya believes in learning through joyful experiences, where celebration becomes learning in disguise. This year, the school organized the Lemonade Party, where children mixed and served lemonade, learning teamwork and responsibility. The Mango Party introduced students to different mango varieties while helping them understand fruits and seasonal changes. These fun-filled activities supported the development of motor skills, food awareness, and sharing habits, while fostering joyful peer interactions.



ANNUAL FUNCTION

The Annual Function was held on 1st March 2025 at IIT Kanpur's Main Auditorium, with 100% student participation—a proud Kislaya tradition. Dance teachers Gautam Srivastava and Rohith Shah choreographed a range of lively performances. Highlights included Saraswati Vandana, a play on Subhash Chandra Bose, salsa, folk dances, and theme-based acts on Krishna and environmental awareness. The event concluded with prize distribution and refreshments for the students. The enthusiasm, joy, and appreciation from parents made it a truly memorable celebration.

OPPORTUNITY SCHOOL

Opportunity School at IIT Kanpur, established in 1967, is a longstanding educational initiative dedicated to providing quality education to underprivileged children in and around the IIT Kanpur campus. Starting with just six students, the school now serves around 300 students from kindergarten to class VIII in a modern, well-equipped facility. Recognized by the UP Board of Education, the school emphasizes holistic development through academics, co-curricular activities, and skill-building workshops, including computer literacy, science labs, and creative arts. Students benefit from minimal fees, free books and stationery, daily nutritious snacks, and a nurturing environment with playgrounds and modern classrooms. Managed by a committee of IIT professors and education experts, Opportunity School continues to expand its infrastructure and academic offerings, with future plans to upgrade to high school level and further enhance its facilities and teaching resources, ensuring equitable access and empowering students for independent, successful futures.



EVENTS & ACTIVITIES

Ambedkar Sewa Samiti Activity

A General Knowledge Quiz was held on 4th April 2024 for students of classes 6–8. Winners received prizes, while all participants were given water bottles as tokens of encouragement. Students also gave a graceful dance performance at the Outreach Auditorium on Ambedkar Jayanti.

CHESS WORKSHOP

Organized by the IITK Chess Club, the workshop for classes 3 and 4 introduced students to chess fundamentals. Chess boards were also donated for continued practice and enthusiasm.



PANCHAMRIT

The school also initiated the Panchamrit mid-day nutrition program in collaboration with Hall 5 of IIT Kanpur.

VIGYAN VEETHIKA

A special event, Vigyan Veethika 2024, marked the first annual event at the science lab and spanned three days of science demonstrations, interactive lectures, and a model-making competition. The event featured sessions by IITK faculty and enthusiastic participation from students across Kanpur, making it a truly memorable scientific celebration.

INAUGURATION OF VIGYANALAYA STATE-OF-THE-ART SCIENCE LAB

The inauguration of Vigyanalaya, a state-of-the-art science laboratory at Opportunity School, IIT Kanpur, was held on 20th April 2024, marking a significant step in the school's journey towards scientific learning. It was a dream project of Prof. H C Verma and Late Prof. Sameer Khandekar, to establish an applied science laboratory at Opportunity School. The lab was inaugurated by Prof. Abhay Karandikar, Secretary, Department of Science and Technology, in the presence of distinguished guests including Prof. S. Ganesh, Prof. Sudeep Bhattacharjee, and Padma Shri Prof. Verma. The lab is mainly set up with the generous support of Shiksha Sopan and Kewal Engineering Pvt. Ltd.



WORKSHOPS AND SUMMER CAMPS

The school organized a variety of enriching workshops and summer camps for students from Grades 3 to 8 from 21st to 30th May 2024. Students participated in sessions on sports, yoga, painting, computer literacy, embroidery, and fun-based mathematics, guided by volunteers from IITK and Shiksha Sopan. A special camp on **Arduino programming** introduced students to the basics of robotics and self-driving car models. These sessions gave students opportunities to explore their interests beyond the classroom and boosted their confidence in STEM-related subjects.

Additional workshops on topics like handwriting, electronics, climate change, and water conservation were also conducted. A standout event was the **“Life and Carbon”** awareness program, which included interactive sessions, quizzes, and creative competitions to promote environmental awareness among young learners.





STUDENT ACTIVITIES & ACHIEVEMENTS

This year was filled with competitions and celebrations that allowed students to showcase their creativity and talents. Events included Hindi and English handwriting contests, a Paheli quiz, Ramayana quiz, and poetry recitation sessions. Students also took part in an eco-friendly product competition where they created wall hangings and decorations using recycled materials. Janmashtami, Dussehra, Diwali, Teachers' Day, Republic Day, and other festivals were celebrated through assemblies, performances, and class activities, creating a rich cultural learning environment.



Students of Opportunity School achieved great success in various external events. During Wildlife Week 2024 at Kanpur Zoo, they won several first prizes in quizzes, rangoli, mehndi, and drama competitions. One of the students, Rahul from Class 7th, received an Inspire Fellowship for his innovative idea of a Metro Ambulance. Students also presented at the G-20 Y20 Youth Consultation Summit and participated in inter school Sanskrit and Science fairs.



COMMUNITY ACTIVITIES AND VISITS

The school welcomed several dignitaries and visitors throughout the year. These included Mr. Alok Agarwal from Reliance Industries, the Akshay Patra team, and alumni donors exploring ways to support the school. Students were also taken on educational visits to the Critical Zone Observatory and Environmental Monitoring Stations as part of their science curriculum. Workshops were hosted by IIT Kanpur faculty and included themes such as drinking water conservation, robotics, and light physics.

CAMPUS SCHOOL

Established on 14 July 1964 under the visionary leadership of Late Dr. P.K. Kelkar, the Campus School was conceptualized to provide quality primary education for the children of IIT Kanpur staff. With guidance from international education experts through the KIAP Programme, the school was built on a strong foundation of modern child development and teaching practices. It operates as a nonprofit under IIT Kanpur.



ACADEMIC & CO-CURRICULAR ACTIVITIES

This year, a variety of fun and meaningful activities were conducted to ensure every student participated. These included competitions like recitation, fancy dress, and story writing. Celebrations such as Sports Day, Teacher's Day, and Children's Day brought joy and excitement. Cultural events like special assemblies and science demonstrations enriched the learning experience. Students from classes KG to V went on excursions to places like the Kanpur Zoo, ISKCON Temple, and Bithoor. Community drives such as plantation activities and open house events further encouraged learning beyond the classroom.



INFRASTRUCTURAL CHANGES

This academic session brought numerous enhancements to the learning environment:

- Swings in play area
- New teaching aids for KG students
- Refurbished labs, staff rooms, and office spaces
- Installation of interactive panels, sound systems, laptops, and printers
- New furniture in English, Math, and EVS labs
- Collection of used electronic devices from IIT departments through “Our Community–Our School” campaign
- Refurbished labs, staff rooms, and office spaces
- Introduction of computers, audiovisual aids, printers, and sound systems
- New wooden cupboards, sunmica tables, and age-appropriate furniture
- PVC wall and ceiling panels with electrical upgrades for safety and aesthetics



SOCIETAL IMPACT

The infrastructural improvements weren't just physical upgrades, they were steps toward educational empowerment: Interactive panels made classes engaging and informative, the EVS lab inspired curiosity through hands-on learning, and a strong sense of community was fostered through parental involvement and teacher collaboration.

In every celebration, every upgrade, and every smile, Campus School continues to echo its legacy of love, learning, and leadership. From tradition to technology, we are moving forward rooted in values, reaching for the stars.



BATCH INITIATIVES

Over the years, the alumni of IIT Kanpur have played a significant role in advancing the institute's mission. Their generous contributions have enabled the establishment of numerous scholarships, faculty and student awards, endowed faculty chairs, community welfare initiatives, and critical infrastructure development and maintenance. With their unwavering support, IIT Kanpur continues to grow and excel, with its alumni serving as enduring pillars of strength for the institute.

THE CLASS OF 1967

The Class of 1967 donated Rs. 0.3 Cr. towards student scholarships. This support will help deserving students in their academic pursuits.



THE CLASS OF 1999

The Class of 1999 pledged Rs. 13.6 Cr. towards the 'Class of 1999 Batch Fund' and 'Student Scholarship' to support student scholarships and other key initiatives at the institute. This generous contribution will play a vital role in fostering academic excellence and enhancing the overall student experience, reflecting the batch's deep-rooted commitment to giving back to their alma mater.



THE CLASS OF 1985

The Class of 1985 pledged Rs. 1.05 Cr. towards the Class of 1985 Batch Fund. This contribution will serve as a stepping stone for future initiatives that enrich the IITK community, empowering students and nurturing a culture of excellence and inclusion across the campus.



THE CLASS OF 1975

The Class of 1975 has pledged Rs. 5 Cr. towards the Batch Fund and the establishment of a Faculty Chair. Their thoughtful contribution will significantly strengthen faculty excellence and foster academic leadership, while also enriching the larger ecosystem of the institute.



THE CLASS OF 1980

The Class of 1980 has pledged Rs. 4.2 Cr. towards supporting Hall 3 and the Girls' Hostel, student and research awards, and 'The Humanities-Technology Bridge' a heartfelt tribute to Prof. Mahajan and Prof. Dhanagare.



THE CLASS OF 1965

The Class of 1965 has pledged Rs. 2.5 Cr. towards the Pioneering Research Excellence and Innovation Award.



COMMUNITY WELFARE

The institute continues to drive community welfare through impactful initiatives in education, skill development, and social upliftment by the generous funds received from our alumni, well-wishers and from empowering rural youth through training programs to promoting hands-on science learning and sustainable livelihoods, these efforts are transforming lives at the grassroots level. The focus remains on inclusivity, innovation, and long-term empowerment, ensuring that growth reaches every section of society.

SHIKSHA SOPAN

Shiksha Sopan, a registered NGO based at IIT Kanpur, is dedicated to uplifting underprivileged communities through holistic education. Rooted in the principles of Shiksha (education), Sanskar (values), and Swavlamban (self-reliance), the organization focuses on providing quality science education to students from classes 6th to 12th, primarily from economically weaker sections.

Working in collaboration with government schools across Kanpur Nagar, Kanpur Dehat, Fatehpur, Orai, Kannauj, and nearby districts, the initiative aims to strengthen laboratory facilities and promote hands-on learning. Regular teaching sessions help students grasp scientific and mathematical concepts to nurture curiosity, critical thinking, and confidence among students, build a foundation, understand the basics of engineering, and enhance overall academic performance all in Hindi, to ensure accessibility. This effort not only improves educational outcomes but also promotes long-term growth and self-reliance.



INAUGURATION OF VIGYANALAYA AT OPPORTUNITY SCHOOL, IIT KANPUR

The inauguration of Vigyanalaya, a state-of-the-art science laboratory at Opportunity School, IIT Kanpur, was held on 20th April 2024, marking a significant step in the school's journey towards scientific learning. It was a dream project of Prof. H C Verma and Late Prof. Sameer Khandekar, to establish an applied science laboratory at Opportunity School. The lab was inaugurated by Prof. Abhay Karandikar, Secretary, Department of Science and Technology, in the presence of distinguished guests including Prof. S. Ganesh, Prof. Sudeep Bhattacharjee, and Padma Shri Prof. Verma. The lab is mainly set up with the generous support of Shiksha Sopan and Kewal Engineering Pvt. Ltd.



A paper recycling unit was introduced at Vigyanalaya to foster sustainability, where students created quality recycled paper while engaging in eco-friendly, hands-on learning. Over the past few months, Vigyanalaya and Shiksha Sopan have hosted a series of impactful events that reflect their expanding role in science education and outreach. The journey gained momentum with Vigyateet, an experimental science summer camp held in May-June. Around the same time, a vibrant science show at Ganeshwar Temple drew strong community engagement, and the First Sunday Club continued its regular



teacher training sessions. Early June saw a collaborative visit by SINSME Foundation and Antariksha India to Sopan Ashram, furthering efforts in space science awareness. One of the major highlights was the National Workshop of Utsahi Physics Teachers (NWUPT-2024), a prestigious gathering of educators. In July, renowned academician Prof. Venkatraman Gopalan visited Vigyanalaya, followed by multiple school visits, including ITI Bilhaur, Jawahar Navodaya Vidyalaya, Kendriya Vidyalaya, and Seth Anandram Jaipuria, Lucknow. Science shows and hands-on workshops were conducted in Varanasi, various schools in Kanpur, and Wisdomwood Public School, igniting scientific curiosity among students. The season culminated with NAEST-2024, a national experimental skill test, held in September, along with the JAM-NGPE preparation course, which supported aspiring students preparing for advanced science examinations.

SCIENCE LAB ACTIVITIES

Through these hands-on science lab sessions, students from classes 5 to 7 developed a deeper understanding of real-world scientific concepts. They learned how to test nutrients in food, group and separate materials based on properties, measure temperature and observe heat transfer, and identify acids and bases using natural indicators. Younger students explored measurement techniques, practiced estimation, understood magnetism, and even calculated speed through fun experiments like magnetic car racing. Overall, these activities helped build observation skills, logical thinking, and a scientific mindset in an engaging and interactive way.



SOCIETAL IMPACT

In the last two years, the initiative has impacted nearly 10,000 students and 150+ teachers by making science more accessible, practical, and engaging. Expert visits, hands-on demos, and workshops like **Science vs Magic** built scientific curiosity and critical thinking. Teachers grew through **First Sunday Club**, while students prepared for national exams via **NAEST** and **JAM-NGPE**. Real-world exposure came through industry visits, and events like **Batashe** and **Chat** built strong community bonds. With active participation from rural schools and under-resourced students, this journey continues to bridge the gap between science, society, and opportunity.



RANJIT SINGH ROZI SHIKSHA KENDRA

Established in 2021 as a visionary social endeavour of IIT Kanpur, the Ranjit Singh Rozi Shiksha Kendra (RSK) stands as a tribute to the generous legacy of Late Dr. Ranjit Singh (BT/MME/1965), a distinguished alumnus from the pioneer batch.

The Ranjit Singh Rozi Shiksha Kendra (RSK), IIT Kanpur, has successfully completed four impactful years, guided by the vision of Late Dr. Ranjit Singh. Focused on providing free, quality education to rural children and skill-based training to youth, RSK has expanded its reach and programmes steadily. The year 2024–25 marked a surge in new initiatives, community participation, and collaborations. With growing interest from outside the state, including the Department of Education, Tripura, RSK is evolving into a model for rural upliftment through education and livelihood.

The programmes implemented during the financial year 2024-25 are following-

- (1) Online Rural Education Initiative (OREI)
- (2) Design Development Programme: Kalagram
- (3) Pottery Development Initiative
- (4) Solar Dehydration: Value addition of fruits and vegetables
- (5) Skilling Development Initiative – Leather Stitcher Course and Sewing Machine Operator
- (6) Unnat Bharat Abhiyan

ONLINE RURAL EDUCATION INITIATIVE

To bridge the educational gap between urban and rural India, RSK launched the Online Rural Education Initiative (OREI), a tech-enabled, volunteer-driven programme. Through this model, PhD scholars from IIT Kanpur deliver high-quality Science and Math lessons to students of classes 9 to 12 in rural classrooms virtually, ensuring accessibility and academic excellence. In the academic year 2024–25, OREI expanded to 11 schools, conducting 966 online classes over 181 working days, with a consistent schedule of six classes per day. Subject-wise, 514 classes were held in Mathematics, 173 in Chemistry, 168 in Physics, and 111 in Biology. With 50+ dedicated volunteers, this initiative has gained recognition from the Government of Uttar Pradesh, validating its scalable and sustainable approach to rural education through technology and mentorship.



OREI classes being attended by students of Shri Ram Janki Inter College, Bithoor

LAUNCH OF YOUTUBE CHANNEL

To broaden access to quality learning resources, RSK launched its official YouTube channel in February 2025. The platform hosts recordings of online classes, enabling students to revisit lessons at their own pace. These open-access videos also serve as a valuable tool for teachers, supporting classroom instruction and paving the way for innovative teaching models like the flipped classroom approach.

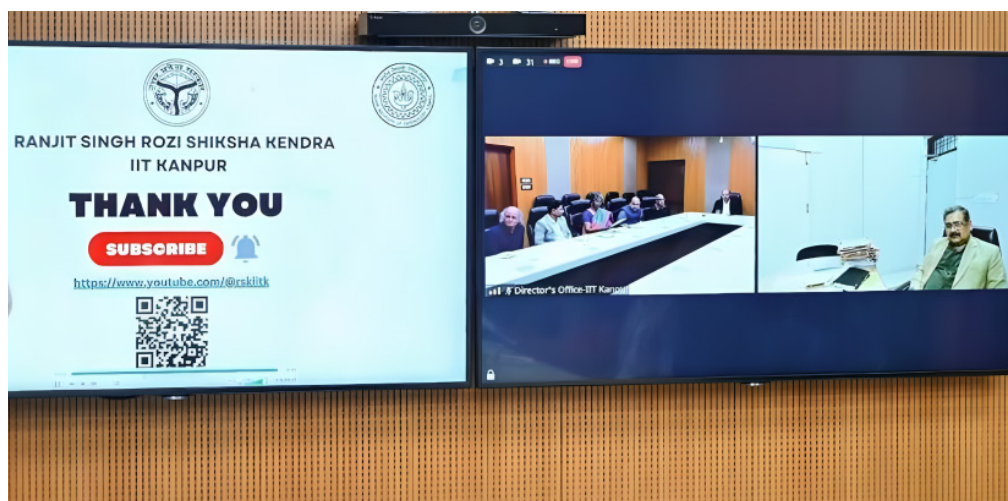

Inaugural address by Additional Director, UP Madhyamik Shiksha Parishad

EDUCATIONAL TOURS

RSK organized eight educational tours for government school students, blending hands-on science activities with real-world learning to spark curiosity and inspiration.

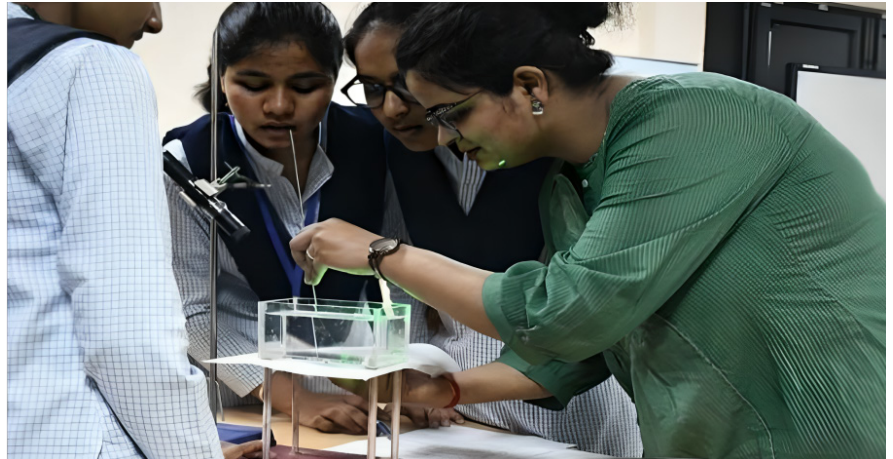

WORKSHOP ON BASIC ELECTRONICS & ARDUINO

A Basic Electronics and Arduino workshop was conducted in May 2024 for rural students (Classes 8–11), introducing them to circuits, sensors, and coding to spark early interest in engineering and innovation.



Basic Electronics and Arduino workshop

LAUNCH OF SCIENCE KIT (LAB IN A BOX)

A low-cost Science Kit with 100+ hands-on experiments and video guides was launched to enhance STEM learning in resource-limited schools, supported by SBI.



Inaugural of the Science Kit by officials from SBI, and demonstration of the kit by RSK team

WORKSHOPS ON ASTRONOMY: NIGHT SKY WATCHING SESSIONS

A Night Sky Viewing program was held on 2nd October 2024 at Shri Ram Janki Inter College, Bithoor, engaging 75 students in astronomy, with support from IIT Kanpur's Astronomy Club and faculty.



Sessions on astronomy and night sky watching for school children

ESTABLISHMENT OF A DESIGN DEVELOPMENT PROGRAMME

Kalagram, the Design Development Centre at RSK, was launched in September 2024 as a CSR initiative of IPM India to bridge traditional craftsmanship with modern design thinking. Inaugurated in January 2025, it serves as a collaborative space for artisans, designers, and rural entrepreneurs to co-create innovative, sustainable, and market-ready products. Aligning with the One District One Product (ODOP) scheme, Kalagram fosters artisan empowerment through partnerships with institutions like IICD Jaipur, CSJMU Kanpur, and Viswa Bharti, while promoting heritage crafts through design-led interventions and government convergence.



Inauguration of Kala Gram Design Development centre

POTTERY DEVELOPMENT INITIATIVE OF BITHOOR

Pottery Development Initiative of Bithoor: The Pottery Development Initiative at Bithoor, launched in 2023, aims to revive the region's fading traditional craft by linking over 100 potters with government schemes and modern design interventions. Now integrated into the Kalagram project, it collaborates with leading design institutions to modernize techniques, enhance product appeal, and restore the livelihood potential of this heritage craft.



A design competition held jointly by RSK and Dept of Fine Art, CSJMU in Sept 2024

During 2024–25, RSK registered 105 potters through a household survey, organized a design competition at CSJMU, and conducted a hands-on workshop on glazing and kiln techniques. Exposure visits to Khurja and UPITEX were arranged, and potters showcased their work through product catalogues and stalls at the Flower Show and Unnati Utsav at IIT Kanpur.



Catalogue of pottery products from the artisans associated with RSK

A proud milestone for RSK's Design Development project came when its handcrafted pottery was presented as a gift to Hon'ble Prime Minister Shri Narendra Modi, inspiring the artisan community deeply.



Ceramic designer Ms. Shailly Sangal and potter Shri Ram Shankar Prajapati of RSK presenting a handcrafted pottery gift to the Honourable Prime Minister, Shri Narendra Modi (30th April, 2025)

HOME FURNISHING OF KANPUR

RSK's home furnishing cluster in Kanpur empowered 76 women artisans through design workshops, upcycling projects, and market exposure. Four artisans began their entrepreneurial journey under the CM Yuva Udyami Yojna, while products were showcased at UPITEX, the Flower Show, and Unnati Utsav, reflecting the cluster's high potential in sewing, embroidery, and sustainable home décor.



Participation by Artisans in the exhibition at Flower Show IIT Kanpur February 2025



HMP products of Kalpi

HANDMADE PAPER OF KALPI

The Handmade Paper (HMP) Revival Project in Kalpi, a GI-tagged traditional craft, was initiated by RSK to restore its lost potential as an eco-friendly, biodegradable product. In collaboration with IICD Jaipur and IIT Kanpur, the project focuses on design innovation, strategic positioning, and artisan training. A total of 58 artisans were registered through a household survey, followed by multiple stakeholder meetings, exposure visits, and a 3-day paper conversion workshop. The Jalaun district administration and RSETI have joined hands for training and revival efforts, while IIT Kanpur is producing a documentary to highlight Kalpi's heritage craft.

SOLAR DEHYDRATION OF FRUITS AND VEGETABLES

In 2024–25, RSK launched a NABARD-supported project on solar dehydration of surplus fruits and vegetables to reduce post-harvest losses and boost rural livelihoods. Implemented across four farming clusters in Kanpur Nagar and Dehat, the initiative trains 56 farmers, especially women in solar-based food processing. IoT-enabled dryers with real-time monitoring via the in-house 'Solar Netra' app were deployed. With 50+ dehydration trials, lab testing, packaging, and live demonstrations conducted, the project is paving the way for sustainable, tech-driven micro enterprises in agriculture.

Scenes from the workshop conducted on solar dryer and address by agriculturist Shri Satish Subhedar, and demonstration by farmer on drying of tomatoes Skilling of rural youth.

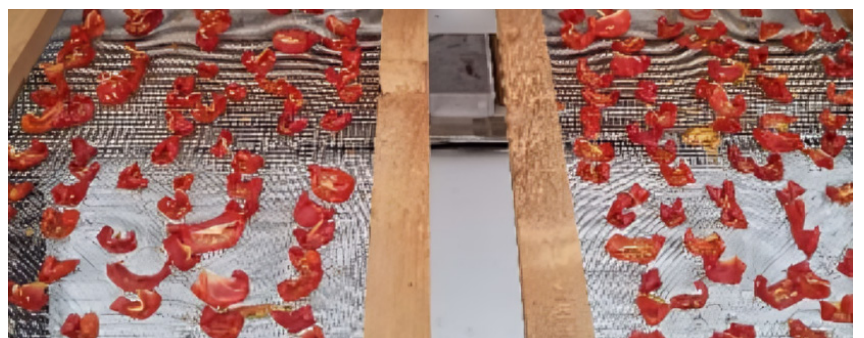

SKILLING OF RURAL YOUTH

With NABARD's support, RSK trained 172 rural youth in leather stitching and sewing machine operations across 7 batches in 2024–25. Through hands-on sessions, soft skill development, and On-Job-Training at Prachi Leathers, 153 trainees completed the course. Partnering with industry leaders and NSDC-affiliated Pratham Education, the program aligns with national skilling goals and is helping youth gain employment, explore entrepreneurship, and step into economic independence with confidence.



Training being given at RSK IIT Kanpur

UNNAT BHARAT ABHIYAN

As both a Participating Institute (PI) and Regional Coordinating Institute (RCI), RSK actively led UBA initiatives in 2024–25. The flagship event Unnati Utsav 2025 held on March 1–2, brought together 25 PIs, 100+ villagers, and experts to discuss rural transformation and women empowerment. Key exhibits showcased innovations in organic farming (ZBNF), rural health, online education, artisan products, and a Smart Dustbin built using Arduino by Rajkiya Mahila Polytechnic, Mahoba.



Inauguration of Unnati Utsav 2025 by Mrs Aarti Gupta

TREE PLANTATION DRIVE; EK PED MA KE NAAM

On 13th August 2024, RSK joined various PIs in celebrating Independence Day through a tree plantation drive and painting competition under the campaign 'Ek Ped Maa Ke Naam', with activities held at Government High School, Baikunthpur.

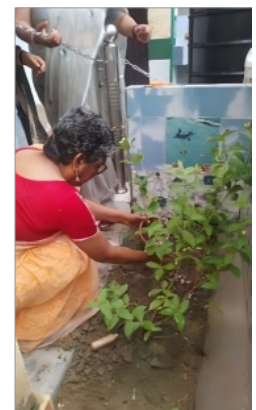

Tree plantation arrive at GHS Baikunthpur school

GRAM SABHA

On 2nd October 2024, the UBA team of IIT Kanpur participated in the Gram Sabha at its adopted village Hridaypur, engaging 900 villagers, faculty, students, and officials from the Panchayati Raj Department and NRLM in a collective dialogue on rural development.



Scene of gram sabha at Hridaypur panchayat 2024

PRAYAS

Prayas is a student-led initiative of IIT Kanpur, supported by alumni, donors, and well-wishers, focused on providing education to the marginalized children from in and around IIT Kanpur. It is currently under the Presidential Council in the Students' Gymkhana, IIT Kanpur. It is powered by volunteers who provide free education and learning support to marginalized children from nearby communities. With its mission of 'Education for All', Prayas strives to ensure inclusive, equitable opportunities and a brighter future for every child.

EVENTS

Farewell

A farewell was held for graduating volunteers, with cultural performances and handmade souvenirs by Prayas students.



Teacher's Day Celebration

Teacher's Day was celebrated where Prayas students expressed their gratitude to volunteers through heartfelt gestures like handmade cards and speeches.



Annual Day

Prayas Annual Day gave students an opportunity to explore their creativity through guided cultural performances.

Children's Day and Diwali Celebration

Students enjoyed treats and received stationery. Volunteers also delivered inspiring speeches to uplift and motivate the children.



Christmas Celebration

Prayas students joyfully celebrated the birth of Jesus Christ, fostering cultural awareness and embracing India's diversity. The festivities included plays, speeches, dance, and music.

Republic Day Celebration

On 26 January, Prayas celebrated its birthday and Republic Day with a special assembly at OAT featuring flag hoisting, sweets distribution, and cultural performances.

Prayas Picnic

The Prayas team visited Science City and The Residency Lucknow for their annual picnic. The day was filled with exploration, learning, and joy as students and volunteers engaged in interactive exhibits and history, making it a truly special experience.

Holi Celebration

On 13 March, an eco-friendly Holi was celebrated at OAT with gulaal, joined by students and volunteers.



Year-Round Events

Workshops and sessions were conducted in collaboration with IITK clubs (Dance, Music, Chess, Finance, Astronomy, etc.), along with a drawing competition supported by DOMS. Volunteer intake drives were held four times during the year, while Volunteer Week encouraged monthly student-volunteer interactions. Awareness sessions on gender equality, menstrual and sexual health were also organized with trained professionals.

Other Activities

Elections were held to select Mantris, a 20-day cricket tournament (Prayas Premier League) was organized, English classes were conducted to enhance language skills, and old bicycles were distributed to children in need.



RESEARCH SUPPORT

IIT Kanpur continues to strengthen its position as a global hub for innovation, research excellence, and technology transfer. With a remarkable number of intellectual property filings, impactful product launches, and successful technology licensing, the Institute exemplifies India's growing R&D leadership and its ability to translate advanced research into real-world impact.

PATENTS FILED TECHNOLOGIES LICENSED

IIT Kanpur has set a new benchmark in innovation by filing 156 IPRs in the financial year 2024–25 the highest ever in a single year by the institute marking the fourth consecutive year of breaking its own records. The filings span 123 Indian patents, 15 design registrations, 2 copyrights, 6 trademarks, and 10 international patents, including those from the US, Taiwan, China, Malaysia, and Europe. A total of 148 IPRs were granted in this period, and 6 technologies were successfully licensed. This achievement brings the institute's cumulative IPR count to 1260, with 878 granted and 154 technologies licensed till date, reflecting an impressive licensing rate of 12.22%. These milestones underscore IIT Kanpur's unwavering commitment to cutting-edge research, grassroots impact, and a thriving, innovation-driven ecosystem.

TECHNOLOGIES LICENSED (2024-25)

A patented diagnostic technology for bovine mastitis, developed by Prof. Siddhartha Panda and Dr. Satyendra Kumar at NCFlexE, IIT Kanpur, has been licensed to Prompt Equipments Pvt. Ltd., a dairy tech company active in over 70,000 villages. Titled **“Lateral Flow Immunoassay Strip and Method for Detection of Mastitis in Bovines”** and granted Indian Patent No. 455232, the innovation enables rapid, cost-effective detection of Staphylococcus aureus using a dual gold nanoparticle-based LFIA strip. With high sensitivity, weather stability, and ease of use, it addresses a critical need in the growing veterinary diagnostics market.



IIT Kanpur has re-licensed the technology titled **“School Bag Convertible to Study Table”** (Design Registration No. 287945) to PROSOC Innovators Pvt. Ltd. The innovative school bag, developed by Mr. Eshan Sadasivan (DP), Prof. Shantanu Bhattacharya (ME), Prof. Mainak Das (BSBE), Mr. Toshib Bagde (DP), and Mr. Abhinav Basak (DP) at IIT Kanpur, features a foldable, height-adjustable study table integrated within the bag. Designed to address the needs of underprivileged students lacking access to basic infrastructure like study tables, DESKIT promotes better posture, improved concentration, and enhanced handwriting, offering a dedicated learning space both at school and home. Lightweight, waterproof, and available in various colours and designs, the bag is a versatile solution for students. Already impacting over 3,50,000 students across 19 Indian states, DESKIT has received support from various government bodies, corporates, and NGOs, including the governments of J&K and Telangana, CSR partners such as Wells Fargo, ONGC, and Aditya Birla, and NGO collaborators like United Way, JSPL Foundation, and Diya India. By re-licensing this innovation to PROSOC, IIT Kanpur reinforces its commitment to accessible, design-driven solutions that promote inclusive and equitable education.



IIT Kanpur has transferred a portable, non-invasive oral cancer screening device, Munh Parikshak, developed by Prof. Jayant Kumar Singh and team (Department of Chemical Engineering). Protected under Indian Patent Application No. 202411015420, the device uses specialized lighting and imaging to detect and classify oral conditions as normal, pre-cancerous, or cancerous, with results instantly displayed via a mobile app and stored on the cloud. With 90% accuracy in clinical settings, the device is safe, radiation-free, and ideal for self-testing. Addressing a critical healthcare challenge especially in India, where oral cancers form up to 40% of total cases. Munh Parikshak offers an affordable, user-friendly solution in a market projected to grow significantly over the coming years.



IIT Kanpur has licensed its innovative **Soil Nutrient Sensing Device** to ScaNxt Scientific Technologies Pvt. Ltd. Developed by Prof. Jayant Kumar Singh and his team from the Department of Chemical Engineering, the patent-pending device (Indian Patent Application No. 202311039511) is a compact, smartphone-compatible tool for real-time soil nutrient analysis. Using Near Infrared Spectroscopy, it assesses multiple parameters without chemical reagents, stores data on a cloud server, and can perform up to 250 tests per charge. Designed to address delays in traditional soil testing, the device offers instant results directly to farmers' smartphones, promoting efficient fertilizer use, higher crop productivity, and environmental sustainability.

Valued at USD 114.43 million in 2024, the Indian soil testing market is projected to reach USD 145.83 million by 2030, growing at a CAGR of 4.08%. As demand for data-driven agriculture rises, ScaNxt plans to take this Made-in-Bharat solution global, empowering farmers with actionable insights. A joint MoU between IIT Kanpur and ScaNxt aims to advance this technology by integrating micro and secondary nutrient detection into the BhuPariKshak device using NIR, IoT, and AI/ML. The device will also support government efforts to build a national soil stack an aggregated database enabling region-specific fertilizer recommendations, improved policy decisions, and long-term soil health monitoring for sustainable agriculture.

For the first time in the history of IIT Kanpur, a trademark bearing the IIT Kanpur logo (Registered Trademark No. 355542, Class 16) has been licensed to a company named Alcraftist.



PRODUCT LAUNCH

IIT Kanpur launched **Anālakshya**, a textile metamaterial-based stealth tech that makes military assets invisible to radar and missile guidance. Licensed to Meta Tattva Systems, it boosts India's defense edge with near-perfect wave absorption. Developed by IITK's Prof. Ramakrishna, Prof. Srivastava, Prof. Ramkumar, and team, this game-changing innovation was unveiled in Nov 2024, with top Indian Air Force leaders and IIT officials endorsing its strategic value.



IIT Kanpur has launched a **Phase Change Material-Based Thermal Management System**, developed by Prof. Sri Sivakumar, with the ability to maintain a consistent temperature range (typically -20°C to -10°C).

This energy-saving tech was unveiled at Abhivyakti'25, and it is designed to ensure energy efficiency and sustainability by offering higher thermal conductivity and energy storage density, making it ideal for applications such as ice cream storage, food preservation, and refrigeration. To showcase its social impact, the institute donated two PCM-powered ice cream carts to local vendors, boosting product quality and cutting energy costs. With applications in drug delivery and solar storage, the innovation reflects IIT Kanpur's vision for sustainable, real-world solutions.

AWARDS

IIT Kanpur bags National Intellectual Property Award 2024

IIT Kanpur was honoured with the prestigious “National Intellectual Property (IP) Award 2024” for being the top Indian academic institution in patent filings. The award was presented at Bharat Mandapam, New Delhi on 26th March 2025 by Hon'ble Minister Shri Piyush Goyal to Prof. Manindra Agrawal, Director, IIT Kanpur, and Mr. Anshu Singh, Research Establishment Officer, SIIC. Adding to the glory, IIT Kanpur



also received the “WIPO National Award for WIPO Users”, recognizing its global-standard innovation and early adoption of WIPO IP services. These accolades celebrate IIT Kanpur’s strong R&D and IP ecosystem, showcasing its commitment to nurturing innovation and driving India’s journey towards self-reliance and technological excellence.

Featured Technologies at IIT Kanpur

A System and A Method For Contactless Automated Crack Extension Measurement (ACEM)”, invented by Dr. Pritam Chakraborty & Mr. Vipin Chandra from the Dept. of Aerospace Engineering is available for licensing having IPA No. 202411022761.

The technology is a simple, user-friendly tool for accurately measuring crack growth in materials under stress, without physical contact. It overcomes traditional method limitations and aids researchers in studying material fatigue and failure.

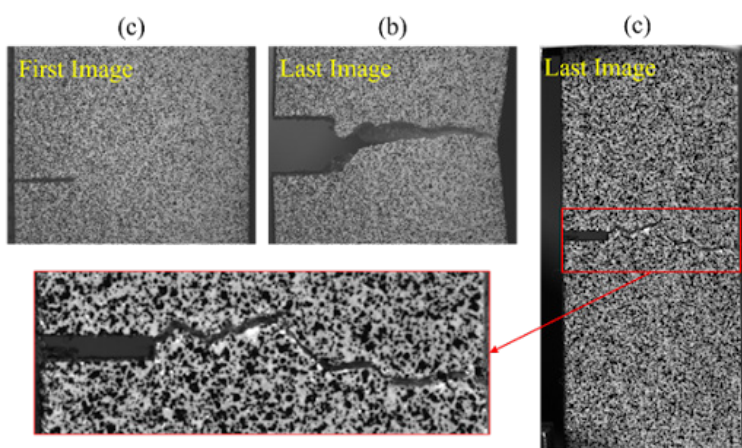

IITK-developed technology titled, “Transdermal Patch for Drug Delivery and Method of Preparation Thereof”, invented by Dr. Animangsu Chatak (Professor, Chemical Engineering, IITK), Mr. Kuldeep Kuhar (Chemical Engineering, IITK), is available for licensing.

The technology (IPA No. 202411034922) is an adhesive patch for transdermal drug delivery, featuring a squeezable reservoir and sticky backing. It simplifies application by eliminating complex microneedle structures and allows simultaneous delivery of multiple drugs.

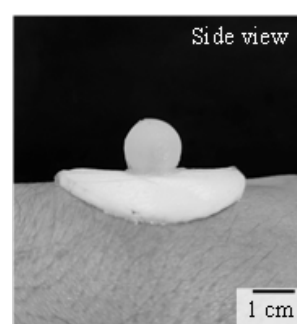
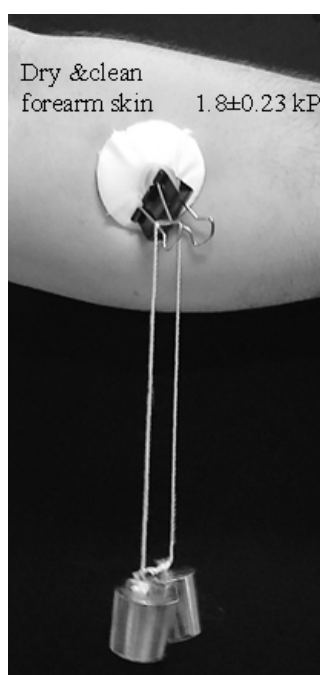

IITK-developed “Portable Readout Unit for Chemiresistive Sensor (PRuCSor)” by Dr. Santosh Kumar Misra and team (IPA No. 202411100478) is available for licensing. This compact, 180g, battery-powered device uses paper-based carbon electrode chips to measure resistance in liquids and features a screen and Bluetooth for easy, portable use.

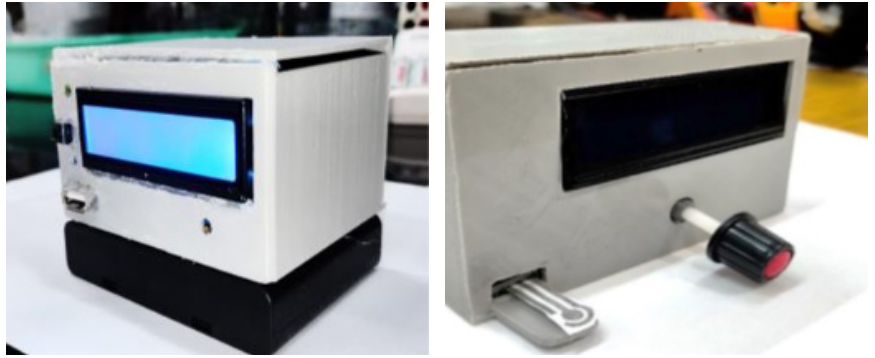

IITK-developed “Portable Readout Unit for Chemiresistive Sensor (PRuCSor)” by Dr. Santosh Kumar Misra and team (IPA No. 202411100478) is available for licensing. This compact, 180g, battery-powered device uses paper-based carbon electrode chips to measure resistance in liquids and features a screen and Bluetooth for easy, portable use.

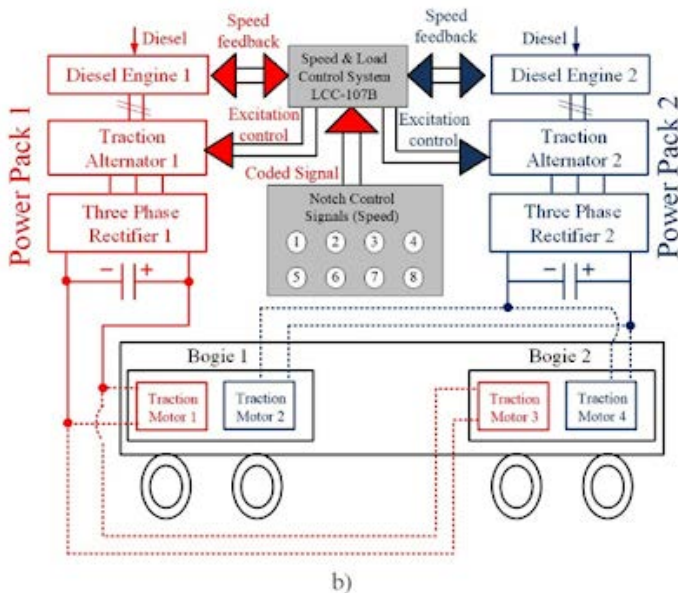

IITK-developed technology, “Fuel Cell and Battery Hybrid Powered Electric Tower Car with DC Traction Motor” (IPA No. 202411068288), by Dr. Prabodh Bajpai, Dr. Amarendra Edpuganti & team, is available for licensing. It replaces diesel-powered tower cars with a zero-emission, fuel-free alternative, combining fuel cells and lithium-ion batteries for efficient, low-maintenance, and sustainable operation.

IITK-developed “Sugarcane Skin Electrode for Electrochemical Sensing” (IPA No. 202411001912), by Mr. Nachiket Gokhale, Dr. Chiranjeevi Vusa, and Prof. Siddhartha Panda, uses sugarcane skin as a sustainable substrate for screen-printed electrodes. It enables applications in healthcare, water monitoring, and portable chemical analyzers, and is available for licensing.

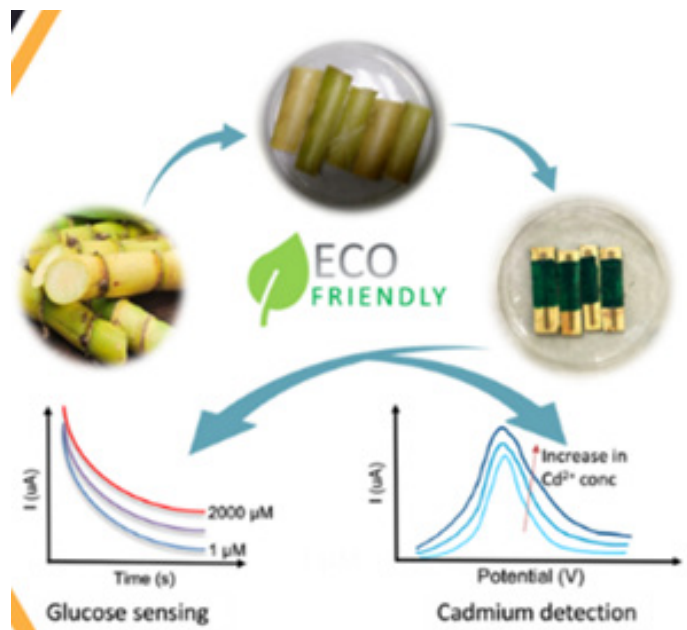

IITK-developed “ Multipurpose Proctoscope, Nested & Hinge Type” by Prof. J. Ramkumar and team is available for licensing. The recyclable Nested Type allows adjustable exposure with a silicone layer and balloon for stability, while the Hinge Type offers easy operation with expandable design and detachable light source.



NEW INITIATIVES

Each year, IIT Kanpur launches new initiatives such as scholarships, faculty chairs, fellowships, awards, medals and distinguished lecture series to enhance the institute's growth. These are made possible through generous donations from alumni, corporates, and well-wishers, reflecting a strong spirit of support and collaboration.



FACULTY CHAIRS

SATYA AND RAO REMALA FOUNDATION CHAIR



Mr. R.V. Rao (MT/CSE/1974) established the Satya & Rao Remala Foundation Chair in the Department of Computer Science & Engineering at IIT Kanpur. Satya and Rao Remala Foundation Chair, instituted under Satya and Rao Remala Foundation, USA, aims to promote research in Artificial Intelligence (AI) in the health tech domain.

SOMA AND MANAS MANDAL CHAIR

Dr. Manas Mandal (BT/CSE/1985) and Dr. Soma Mandal instituted the Soma and Manas Mandal chair and it is open to a distinguished professor in the Department of Computer Science and Engineering at IIT Kanpur.



JAINENDRA NAVLAKHA (1974) CHAIR



Prof. Navlakha (MT/EE/1974) is a Professor & Former Director, School of Computing & Information Sciences at Florida International University and a seasoned Computer Science educator and researcher, known for his leadership and extensive contributions to program accreditation and disaster informatics. His research spans program verification, neural networks, and disaster management, with numerous publications in top journals and conferences. Dr. Navlakha has also earned prestigious accolades, including a Fulbright Senior Scholar Award and an honorary professorship in Peru. Prof. Jainendra Navlakha instituted the Jainendra Navlakha (1974) Chair in the Department of Computer Science and Engineering at IIT Kanpur.

OM PRAKASH GAUTAM FACULTY CHAIR

A Distinguished Alumnus of IIT Kanpur, Dr. Rajeev Gautam is a President & CEO (Retired), Honeywell Performance Materials and Technologies. Over a remarkable 43-year career at Honeywell, Dr. Gautam held multiple leadership roles, including President of Honeywell UOP and Chief Technology Officer of PMT Honeywell. Under his leadership, Honeywell PMT emerged as a \$10 billion global powerhouse in advanced materials, process technologies, and automation.

Dr. Rajeev Gautam (BT/CHE/1974), instituted the Om Prakash Gautam Faculty Chair in the Department of Chemical Engineering at IIT Kanpur.



DISTINGUISHED LECTURE SERIES

IIT KANPUR SWASTIBHAVATU LECTURE SERIES SUPPORTED BY RAWAT FAMILY TRUST



Dr. Shishpal S. Rawat (BT/EE/1979) and his wife Mrs. Hemangi D. Rawat instituted IIT Kanpur Swastibhavatu Lecture Series supported by Rawat Family Trust in sustainability under the Kotak School of Sustainability at IIT Kanpur. It aims to invite national and international thought leaders to share insights, inspire discourse, and drive action in critical areas of sustainable development.

PROF. VINOD K SINGH DISTINGUISHED LECTURE SERIES



Prof. Vinod K. Singh is a distinguished academician, scientist, and leader in the field of Synthetic Organic Chemistry, with a career spanning over three decades. Currently, Prof. Vinod K. Singh is Professor Emeritus and holds an Institute Chair position at IIT Kanpur. Recognized globally for his expertise, Prof. Singh has been honored with prestigious awards like the Padma Shri (2014), Shanti Swarup Bhatnagar Prize (2004), Vigyan Ratna Award of U.P. (2006), J.C. Bose fellowship (2009), Samman Patra by UP Government (2018) reflecting his profound impact on science and education in India and beyond. The Prof. Vinod K Singh Distinguished Lecture Series was established by the Department of Chemistry, IIT Kanpur, along with students, collaborators, family, friends and well-wishers of Prof. Vinod K Singh. The aim of this Distinguished Lecture series under the Chemistry Department is to feature excellent speakers describing organic chemistry in an engaging style with different perspectives.

FACULTY FELLOWSHIPS

PRADEEP JOTWANI YOUNG FACULTY FELLOWSHIP

Mr. Pradeep Jotwani is a seasoned executive with extensive leadership experience. He currently serves on the Board of Directors at ACCO Brands, where he chairs the Compensation and Human Capital Committee, and on the Board of Directors of RAFT (Resource Area For Teaching). He retired from Hewlett-Packard (HP) as Senior Vice President and General Manager, and has held leadership roles at Eastman Kodak and Vector Capital. Mr. Pradeep Jotwani (BT/ME/1975) instituted **The Pradeep Jotwani Young Faculty Fellowship**. The fellowship is open to all departments, with preference given to faculty from the Department of Mechanical Engineering at IIT Kanpur.



CHERIAN AND VIGNY MATHEW FACULTY FELLOWSHIP FOR AI

Mr. Mathew is a Founder at Firebolt Ventures, a Silicon Valley based venture capital firm that has backed over 60 companies started by IITK alumni in the US. Mr. Cherian Mathew (BT/CSE/2008) instituted Cherian and Vignny Mathew Faculty Fellowship for AI which is dedicated to a faculty with research interest in artificial intelligence and to acknowledge young and enthusiastic faculty under 40 years.



DEPARTMENTAL FUNDS

RAJEEV AND JOYCE GAUTAM STUDENT TRAVEL GRANT

Dr. Rajeev Gautam (BT/CHE/1974) instituted Rajeev and Joyce Gautam Student Travel Grant that will help the undergraduate, postgraduate & PhD students of Chemical Engineering Department to present research papers in international conferences.



SATISH AND KAMLESH AGARWAL, HOUSTON, TX USA TRAVEL GRANT



Mr. Satish Agarwal instituted Satish and Kamlesh Agarwal, Houston, Tx USA Travel Grant. This grant will help the faculty and students of the Department of Computer Science and Engineering, IIT Kanpur to present research papers in international conferences.

OTHER ACTIVITIES/SPECIAL PROGRAMS

THE HUMANITIES-TECHNOLOGY BRIDGE: A TRIBUTE TO PROF. MAHAJAN & PROF. DHANAGARE

A new program titled “The Humanities-Technology Bridge: A Tribute to Prof. Mahajan & Prof. Dhanagare” has been established in the Department of Humanities and Social Sciences at IIT Kanpur. Initiated by Mr. Srinath Anantharaman (BT/EE/1980), Founder and CEO of Cliosoft, Inc., the program is inspired by the profound and lasting influence of humanities courses especially those taught by Prof. Mahajan and Prof. Dhanagare. Mr. Anantharaman established this initiative to champion the role of philosophy, ethics, and the liberal arts in shaping well-rounded engineers and thoughtful global citizens. The program fosters meaningful dialogue between technology and the humanities, honoring the legacy of two distinguished professors while reaffirming the value of interdisciplinary learning in today’s STEM-focused world.



FACULTY CHAIRS

Faculty Chair Name	Donor
Satya and Rao Remala Foundation Chair	Mr. R.V. Rao (MT/CSE/1974)
Soma and Manas Mandal Chair	Dr. Manas Mandal (BT/CSE/1985) and Dr. Soma Mandal
Om Prakash Gautam Faculty Chair	Dr. Rajeev Gautam (BT/CHE/1974)
Jainendra Navlakha (1974) Chair	Prof. Jainendra Navlakha (MT/EE/1974)

SCHOLARSHIPS

Scholarship Name	Donor
Dilip Nigam Memorial Scholarship	Ms. Seema Srivastava (Non Alumnus)
Satish and Kamlesh Agarwal EE Scholarship Houston Tx USA	Mr. Satish Agarwal (Non Alumnus)
Manas Mandal Student Scholarship	Dr. Manas Mandal (BT/CSE/1985) and Dr. Soma Mandal
Kaira Karmakar Memorial Scholarship Program	Karmakar Foundation
SDEF Shyam Lata Garg	Mr. Ashutosh Garg (BT/CHE/1974)
SDEF Anand Swaroop Garg	Mr. Ashutosh Garg (BT/CHE/1974)
SDEF Ram Lal Gupta	Mr. Ashutosh Garg (BT/CHE/1974)
SDEF Sheila Gupta	Mr. Ashutosh Garg (BT/CHE/1974)
SDEF Ashutosh Garg	Mr. Ashutosh Garg (BT/CHE/1974)
SDEF Mamta Garg	Mr. Ashutosh Garg (BT/CHE/1974)
Sqn Ldr Sudhanshu Mohan Scholarship	Dr. Chandra Mauli Agrawal (BT/ME/1982)
Lakshmi Hayagrivam Scholarship	Mr. Srikant Ranganathan (BT/ME/1989) (MT/AE/1991)
Late Shri Arun Kumar Sinha Scholarship	Mr. Ashish Kumar Sinha (BT/MME/1988)
Late Dr. Chandra Mohan Singhal Scholarship	Mr. Prakash Mohan (BT/CHE/1988)
Jagdish Chander Khanna Scholarship	Mr. Gautam Khanna (BT/ME/1988)
Airbus-IIT Flying Start Programme	Airbus India Private Limited
Dr. T B Singh Scholarship	Mr. Manoj Singh (BT/EE/1974)
Smt. Kusum Singh Scholarship	Mr. Manoj Singh (BT/EE/1974)
Amitabh and Richa Srivastava Scholarship	Mr. Amitabh Srivastava (BT/EE/1979) and Ms. Richa Srivastava
Jeet Bindra Scholarship for Female students	Mr. Jagjeet Singh Bindra (BT/CHE/1969)

AWARDS

Awards Name	Donor
Prof. J.L. Bansal Best Ph.D. Thesis Award	Mr. Prakhar Bansal (BT/CHE/1994)
Manas Mandal Best PhD Thesis Award	Dr. Manas Mandal (BT/CSE/1985) and Dr. Soma Mandal
DRG Allrounder Award	Mr. Rahul Garg (BT/EE/2001)
Prem Jain Award for Excellence in Sustainability	Prem Jain Memorial Trust
Prof. Pravir Dutt Excellence Award	Prof. Y Sudhakar (BT/CHE/1980), Prof. Aparna Dar (MSc5/MTH/1980) & Prof. Vinayak Eswaran (BT/ME/1980)
Gopal Lakhani Leadership Award for Sporting Event Organization	Dr. Gopal Lakhani (Ph.D./MTH/1971)
Gopal Lakhani Leadership Award for Professional Development Activities	Dr. Gopal Lakhani (Ph.D./MTH/1971)
Gopal Lakhani Leadership Award for Community Services	Dr. Gopal Lakhani (Ph.D./MTH/1971)
V K Jain Award for the Best M.Tech. Thesis in Manufacturing	Dr. V K Jain
The E. Kerala Varma Raja Award	Dr. Vijay K Varma (MT/EE/1978)
P. T. Narasimhan Natural Science Prize	Dr. Vikram Narasimhan (MSc./CHM/1984)
Pioneering Research and Innovation Award for Faculty	The Class of 1965
Pioneering Research and Innovation Award for Student	The Class of 1965

DISTINGUISHED LECTURE SERIES

Lecture Series	Donor
Prof. Vinod K Singh Distinguished Lecture Series	Dept., Family, Friends & well wishers
IIT Kanpur Swastibhavatu Lecture Series supported by Rawat Family Trust	Dr. Shishpal Singh Rawat (BT/EE/1979) and Mrs. Hemangi D. Rawat

FACULTY FELLOWSHIPS

Faculty Fellowships Names	Donor
Cherian and Vignya Mathew Faculty Fellowship for AI	Mr. Cherian Mathew (BT/CSE/2008)
Pradeep Jotwani Young Faculty Fellowship	Mr. Pradeep Jotwani (BT/ME/1988)

DEPARTMENTAL FUNDS

Departmental Fund	Donor
Rajeev and Joyce Gautam Student Travel Grant	Dr. Rajeev Gautam (BT/CHE/1974)
Satish and Kamlesh Agarwal, Houston, Tx USA Travel Grant	Mr. Satish Agarwal (Non Alumnus)

CAMPAIGNS

Name of the Campaign	Goal Amount ₹ (crores)
P.T. Narasimhan Fund for Performing Arts	1
Professor N Sathyamurthy Endowment Lecture Series	0.25
Prof. Kanwar Nalwa Memorial Scholarship	0.25
Annual Giving	2
Professor Vinod K. Singh Distinguished Lecture Series	0.25
V Srinivasan Memorial Fund	0.25

OTHER ACTIVITIES/SPECIAL PROGRAMS

Name of the Program	Donor
The Humanities-Technology Bridge: A Tribute to Prof. Mahajan & Prof. Dhanagare	Mr. Srinath Anantharaman (BT/EE/1980)

ANNEXURE

With a steady rise in the number of donors and a notable increase in CSR contributions, FY 2024–25 saw a remarkable influx of new donors, reflecting growing trust and engagement from individuals and institutions alike. This upward trend across categories underscores DoRA's expanding impact and the collective spirit fueling institutional advancement.

SUPPORT PAST 5 YEARS

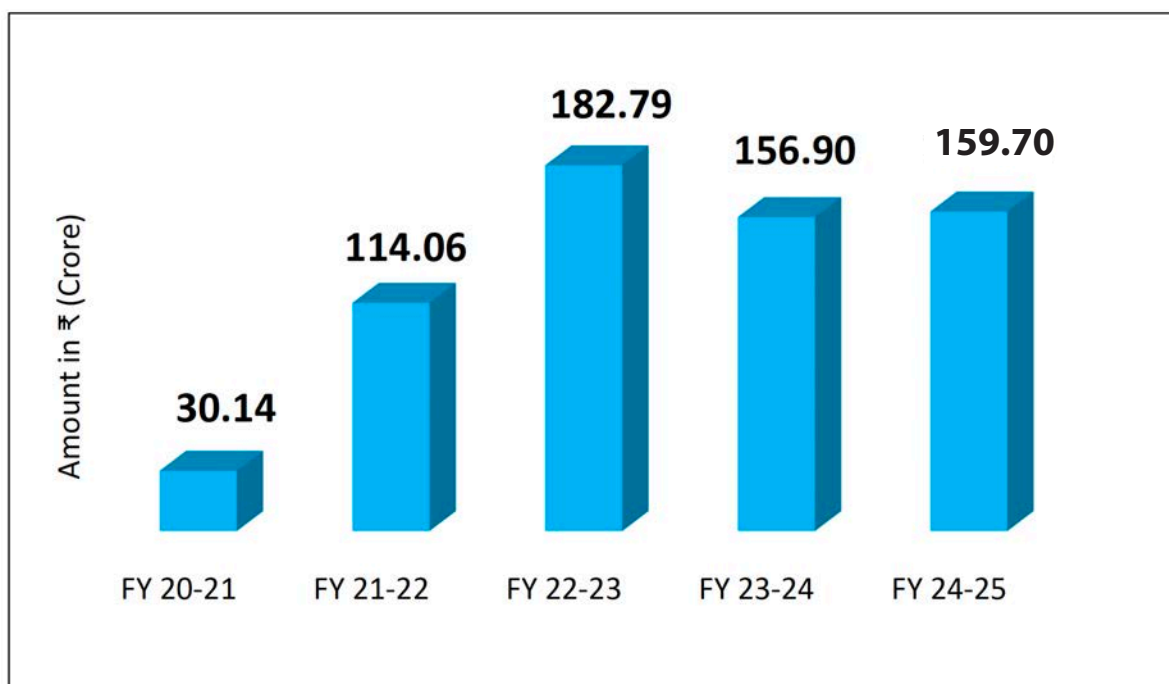

CATEGORY-WISE BREAKUP

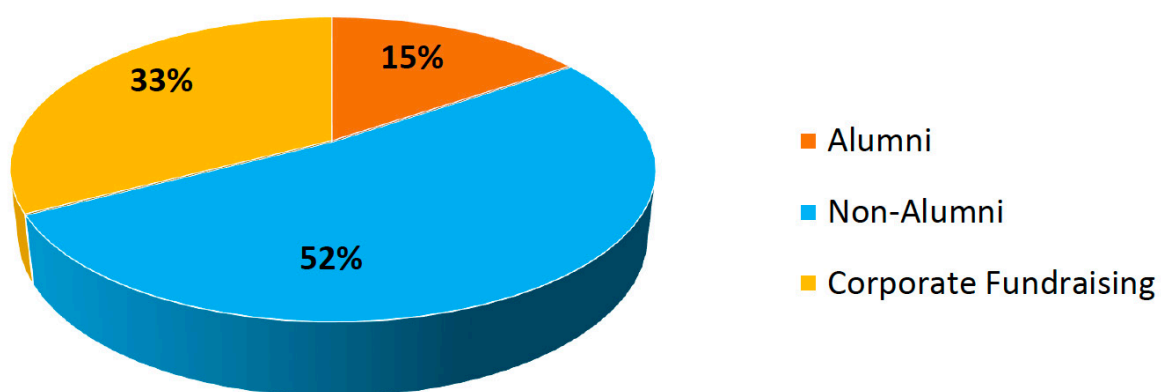

YEARLY GROWTH OF CSR

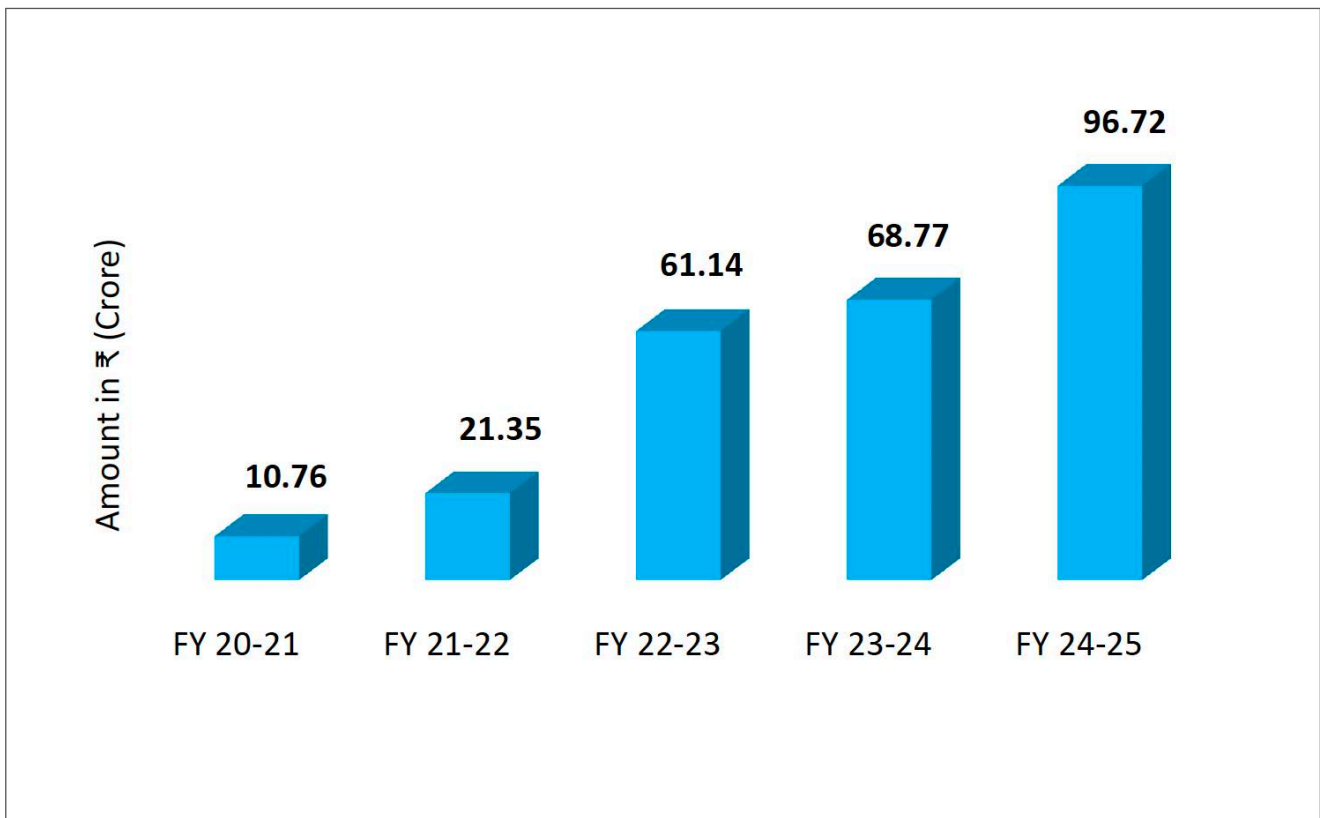

NO. OF DONORS – LAST 5 YEARS

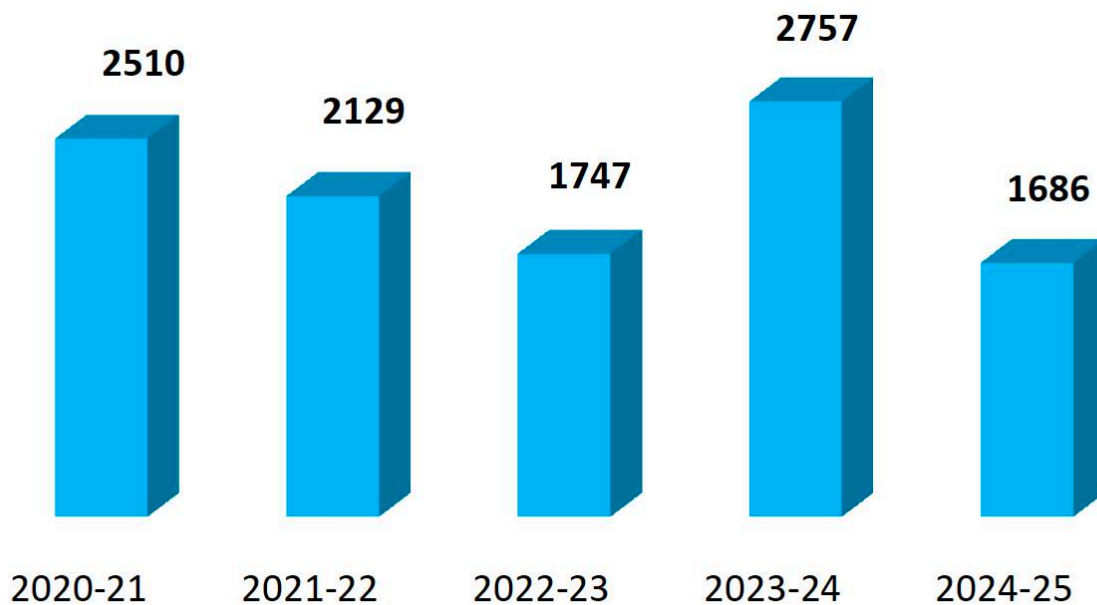

NO. OF DONORS FY 2024-25

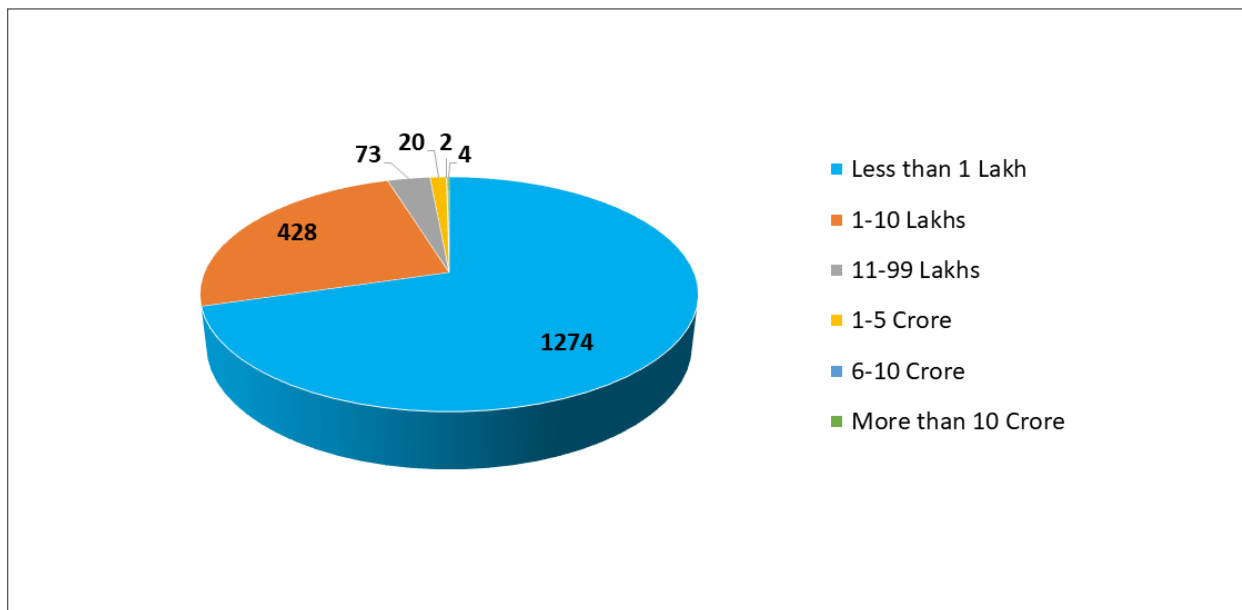

NO. OF NEW DONORS – LAST 2 YEARS

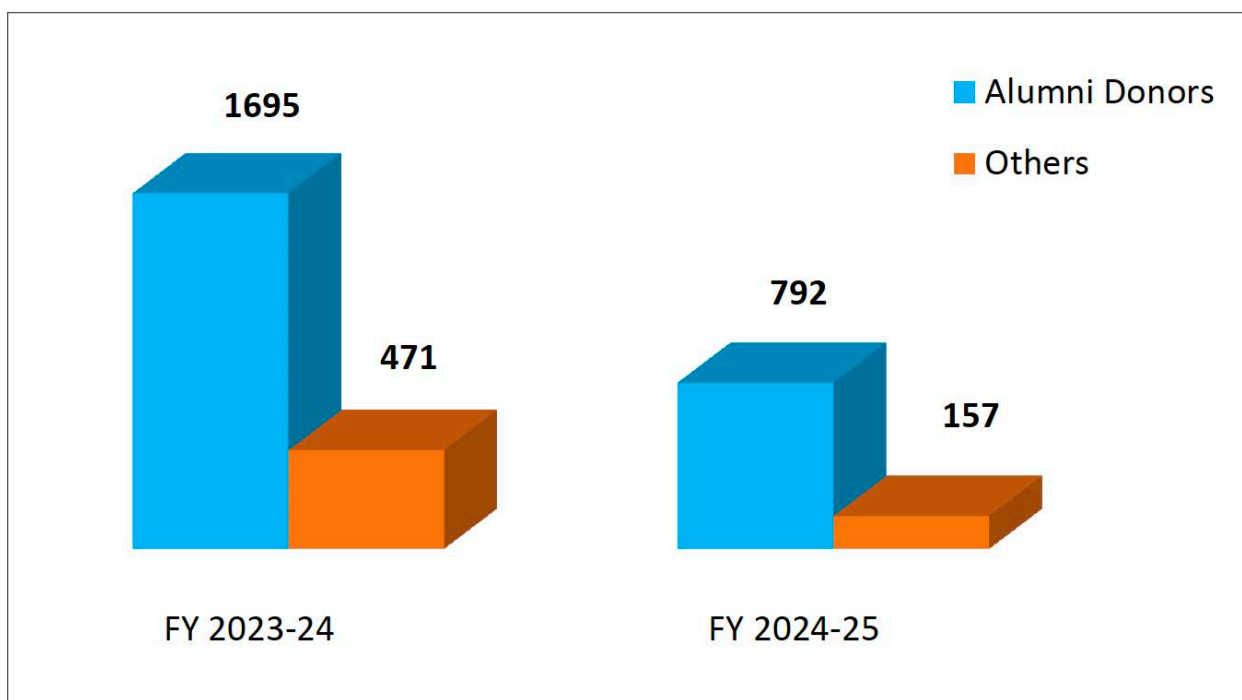

CORPORATE PARTNERS IN FY 2024-25

S. No.	Name	Amount in ₹ Cr.	Purpose
1	IBM India Pvt. Ltd.	₹ 28.11	Gangwal School of Medical Sciences and Technology
2	Kotak Mahindra Bank Ltd.	₹ 17.59	Kotak School of Sustainability
3	AIA Engineering Ltd.	₹ 11.25	Construction of New Hall Residence For Students
4	Citadel Securities India Markets Private Limited	₹ 10.38	Translational and Transformative Training and Investigations Lab at CSE Dept.
5	Citibank N.A.	₹ 9.25	Social Innovation Lab Social Innovation Lab 3.0
6	J K Cement Ltd. Mr. Yadupati Singhania (BT/CE/1977)	₹ 5.00	Gangwal School of Medical Sciences and Technology
7	The Mehta Family Foundation	₹ 4.38	The Mehta Family Centre for Engineering in Medicine
8	HDFC Bank	₹ 3.00	Gangwal School of Medical Sciences and Technology
9	ICICI Foundation For Inclusive Growth	₹ 2.10	ICICI Foundation Digital Health Stack
10	ITC Limited	₹ 1.99	Moisture Resistant Paper Packaging Solutions
11	REC Foundation	₹ 1.24	Gangwal School of Medical Sciences and Technology
12	Portescap India Pvt. Ltd.	₹ 1.14	Scientific Research
13	Tower Research Capital Markets India Private Limited	₹ 0.61	Scientific Research
14	Suraj Logistix Pvt. Ltd.	₹ 0.53	Scientific Research
15	Nmtronics (India) Private Limited	₹ 0.49	Scientific Research
16	IPM India Wholesale Trading Private Limited	₹ 0.46	Design & Development Centre at Rozi Shiksha Kendra
17	In Covid Support Fze Llc	₹ 0.42	BFI - Biome Network grants for biomedical innovators
18	Tcs Fellowship	₹ 0.39	Scientific Research
19	RIICO LTD	₹ 0.23	Centre of Excellence for Innovation in Basic Education (STEM labs)
20	Adani Enterprises Limited	₹ 0.21	Scientific Research
21	4E Software Private Limited Mr. Mahendra Yadav (BT/ME/1999)	₹ 0.20	1999 Batch Fund
22	Khanna and Khanna Limited	₹ 0.20	Scientific Research
23	Airbus India Private Limited	₹ 0.18	Airbus-IIT Flying Start Programme

24	Raramuri Technology Pvt. Ltd.	₹ 0.15	Bhu Parikshak 2.0 Scientific Research
25	Saraswati Heart Care & Research Centre Pvt Ltd. Mr. Surendra Kumar Garg (BT/EE/1972)	₹ 0.15	1972 Golden Jubilee Legacy Project
26	MacDermid Alpha Electronics Solutions India Private Limited	₹ 0.15	Scientific Research
27	Government Of Uttarakhand	₹ 0.15	Support from Department of Higher Education, Government of Uttarakhand
28	ANSYS Software Private Limited	₹ 0.13	Promote education amongst students undergoing Masters program Scientific Research
29	Sahasra Electronics Pvt. Ltd. Mr. Ajit Chakravarti (BT/EE/1972)	₹ 0.12	1972 Golden Jubilee Legacy Project
30	Hindon Filters Pvt. Ltd. Mr. Madan Gopal Agarwal (BT/ME/1974)	₹ 0.12	Class of 1974 Legacy Fund
31	Faiveley Transport Rail Technologies India Pvt. Ltd.	₹ 0.12	Scientific Research
32	ZN Tech Solutions Pvt Ltd	₹ 0.11	Bhu Parikshak 2.0
33	Qualtech Consultants Pvt. Ltd.	₹ 0.11	Project Solar concentrator - Department of SPASE
34	Zopsmart Technology Pvt. Ltd.	₹ 0.10	Bhu Parikshak 2.0
35	Pradeep Metals Limited	₹ 0.10	Class 1978 legacy project
36	Sethi-Sethi Comf Mr. Satish Sethi (BT/EE/1975)	₹ 0.10	1975 Class Fund
37	Humboldt Wedag India Private Limited	₹ 0.10	Pioneering Research Excellence and Innovation Award
38	Frontier Alloy Steel Ltd	₹ 0.10	Scientific Research
39	CSI Engineering Software Pvt. Ltd.	₹ 0.09	NICEE
40	Logic Fruit Technologies Private Limited	₹ 0.09	Gangwal School of Medical Sciences and Technology
41	CREDEX TECHNOLOGY PRIVATE LIMITED Mr. Pradeep Arya (MSc2/MTH-STAT/1999)	₹ 0.09	1999 Batch Fund
42	Rahman Industries Limited	₹ 0.08	Antaragni 24
43	Audify Tech Private Limited	₹ 0.08	Scientific Research
44	Omidyar Network India Advisors Private Limited Siddharth Nautiyal - B.Tech/CSE/1999	₹ 0.07	1999 Batch Fund
45	Hytech Professionals India Pvt. Ltd. Mr. Damnish Kumar (MSc5/MTH/2000)	₹ 0.07	1999 Batch Fund

46	Fashion Suitings Private Limited	₹ 0.06	Scientific Research
47	TVM Signalling And Transportation Systems Pvt. Ltd.	₹ 0.05	Campus School Development Fund
48	Prachi Leathers Pvt. Ltd Mr. Anil Gupta (BT/ME/1978)	₹ 0.05	Class 1978 legacy project
49	Aeron Systems Pvt. Ltd.	₹ 0.05	Gangwal School of Medical Sciences and Technology
50	Hexa Tours And Travels Private Limited	₹ 0.05	Udghosh
51	Bharat Forge Ltd.	₹ 0.05	Team Motorsports Fund
52	Integra Micro Systems Pvt. Ltd.	₹ 0.05	Scientific Research
53	Wonder Illuminate Service Of Education Pvt. Ltd.	₹ 0.05	Opportunity School
54	Apollo Heat Exchangers Pvt. Ltd Mr. Naresh Shah (BT/ME/1974)	₹ 0.05	Class of 1974 Legacy Fund Hall 1 Renovation
55	AlphaGrep Securities Pvt Ltd.	₹ 0.05	AlphaGrep Scholarship
56	PNC Infratech Ltd.	₹ 0.05	Scientific Research
57	PN International Pvt. Ltd.	₹ 0.05	Scientific Research
58	My Home Industries Pvt Ltd	₹ 0.04	Pioneering Research Excellence and Innovation Award
59	Bright 4 Wheel Sales Private Limited	₹ 0.03	Scientific Research
60	Tellapur Technocity Private Limited	₹ 0.03	Pioneering Research Excellence and Innovation Award
61	Continental Belting Pvt Ltd	₹ 0.02	Pioneering Research Excellence and Innovation Award
62	J. K. Fenner (India) Limited	₹ 0.02	Scientific Research
63	Rimjhim Ispat Ltd.	₹ 0.01	Team Motorsports Fund
64	Prem Jain Memorial Trust	₹ 0.01	Prem Jain Award for Excellence in Sustainability
65	Jjg Aero Private Limited	₹ 0.01	Department of SPASE
66	Alkyl Amines Chemicals Limited	₹ 0.01	Annual Gift Programme
67	Evonik India Private Limited	₹ 0.004	Annual Gift Programme
68	My Home Power Consultancy Services Pvt Ltd	₹ 0.002	Pioneering Research Excellence and Innovation Award
69	Surya Powerpacks Mr. Tarun Desai (BT/CHE/1978)	₹ 0.002	Class 1978 legacy project

ALL TOP DONORS (ALUMNI)

6 - 10 Crores					
S. No.	Donor Name	Country	Program	Department	Year
1	Bhadresh Kantilal Shah	India	B.Tech	MME	1974
1 - 5 Crores					
S. No.	Donor Name	Country	Program	Department	Year
2	Hemant Jalan	India	B.Tech	CHE	1977
3	Deepak Mohan Narula	United States	B.Tech	EE	1985
4	Rajeev Gautam	United States	B.Tech	CHE	1974
5	Rao Remala	United States	M.Tech	CSE	1975
6	Jainendra Navlakha	United States	M.Tech	EE	1974
7	Manas Mandal	United States	B.Tech	CSE	1985
8	Manoj Singh	United States	B.Tech	EE	1974
9	Srinath Anantharaman	United States	B.Tech	EE	1980
10	Pawan Tewari	United States	B.Tech	EE	1988
11	Jagjeet S. Bindra	United States	B.Tech	CHE	1969
12	Ranodeb Roy	Singapore	B.Tech	CSE	1990
11-99 Lakhs					
S. No.	Donor Name	Country	Program	Department	Year
13	Anil Bansal	United States	B.Tech	MME	1977
14	Shishpal Singh Rawat	United States	B.Tech	EE	1979
15	Pawan Kumar Goenka	India	B.Tech	ME	1975
16	Satya P. Chauhan	United States	B.Tech	CHE	1968
17	Cherian V. Mathew	United States	B.Tech	CSE	2008
18	Mukul Gupta	United States	B.Tech	CSE	1999
19	Rakesh Rawal	India	B.Tech	ME	1978
20	Chandra Mauli Agrawal	India	B.Tech	ME	1982
21	Gopal Dass Lakhani	United States	Ph.D	MTH	1971
22	Prakhar Bansal	United States	B.Tech	CHE	1994
23	Late. Rathin Datta	United States	B.Tech	CHE	1970

24	Rohit Kumar Toshniwal	United States	B.Tech	CSE	1999
25	Debasis Sahu	United States	B.Tech	CE	1998
26	Sameer Agarwal	United States	MSc5	MTH	2000
27	Utpal Bhattacharya	United States	B.Tech	ME	1980
28	Vimal Parikh	United States	B.Tech	MME	1980
29	Vijay Parikh	India	B.Tech	CHE	1982
30	Vipul Prashad Jain	United States	B.Tech	EE	1978
31	Neeraj Shah (M/s Shah Family Fund)	United States	B.Tech	EE	1994
32	Ashutosh Garg	United States	B.Tech	CHE	1974
33	Saurabh Shrivastava	United States	B.Tech	CSE	1998
34	Vijay Varma	United States	M.Tech	EE	1978
35	Dhawal Kumar	India	B.Tech	CSE	2001
36	Amit Kumar Lohia	India	B.Tech	EE	1985
37	Vivek Jain	United States	B.Tech	CHE	1993
38	Arup Sinha	India	B.Tech	CE	1997
39	Ajay Rooma Dubey	India	B.Tech	CHE	1980
40	Sudhir Mohan Mittal	India	B.Tech	CHE	1970
41	Amitabh Srivastava	United States	B.Tech	EE	1979
42	Devesh Kishore	United States	B.Tech	MME	1998
43	Gautam Dharamshi	United States	B.Tech	CSE	1996
44	Pavan Nigam	United States	B.Tech	EE	1980
45	Rahul Garg	Singapore	B.Tech	EE	2001
46	Seshadhri Comandur	United States	B.Tech	CSE	2003
47	Nishit Verma	United States	B.Tech	CSE	2000
48	Nitin Tandon	India	B.Tech	CHE	1998
49	Siddharth Nautiyal	India	B.Tech	CSE	1999
50	Rohit Jain	United States	B.Tech	CSE	2008
51	Ranavir Bose	United States	B.Tech	EE	1975
52	Nishant Kumar Jha	United States	B.Tech	ME	1998
53	Anil Saigal	United States	B.Tech	EE	1974

54	Barkha Saxena	United States	MSc5	STAT	1999
55	R Ramkumar	Canada	MS-R	ME	2021
56	Sarvan Kumar	India	B.Tech	AE	1975
57	Pawan Kumar Mishra	United States	MSc5	MTH	1999
58	Patke Nandkishor	United States	B.Tech	CHE	1974

1 - 10 Lakhs

S. No.	Donor Name	Country	Program	Department	Year
59	Ananta P Mukerji	United States	B.Tech	EE	1980
60	Ashish Adya	India	B.Tech	MME	1999
61	Debabrata Dash	United States	B.Tech	CSE	1999
62	Deepak Gaur	India	B.Tech	ME	1999
63	Hawaldar Singh	India	B.Tech	ME	1972
64	Sanjiv Puri	India	B.Tech	ME	1985
65	Shreekant M Gupte	United States	B.Tech	ME	1974
66	Sudhakar Gorti	India	B.Tech	EE	1999
67	Sunil Agarwal	United States	B.Tech	EE	1980
68	Dimple Modgil	United States	MSc5	PHY	1990
69	Kamal Kishore Sharma	India	B.Tech	CHE	1969
70	Mahesh Behari Lal	India	B.Tech	CHE	1969
71	Randheer Singh	India	B.Tech	ME	1998
72	Sandeep Gupta	India	B.Tech	CSE	2000
73	Y Sudhakar	India	B.Tech	CHE	1980
74	Anil Kumar	United States	B.Tech	MME	1970
75	Arish Ali	United States	B.Tech	EE	1996
76	Gokul Rajaram	United States	B.Tech	CSE	1995
77	Muktesh Pant	United States	B.Tech	CHE	1976
78	Rishabh Misra	United States	B.Tech	ME	1998
79	Rohit Sharma	United States	B.Tech	EE	1999
80	Sameer Agrawal	India	B.Tech	EE	1998
81	Tarun Anand	United States	B.Tech	ME	1980
82	A. G. Ramakrishna	India	B.Tech	CE	1998

83	Alok Paranjpye	United States	B.Tech	MME	1999
84	Anirban Rahut	United States	B.Tech	CSE	1998
85	Ashish Sinha	United States	B.Tech	MME	1988
86	Ashwin Baidur	United States	B.Tech	EE	1980
87	Balasubramanian Ramachandran	United States	B.Tech	EE	1998
88	Dilip Patil	United States	B.Tech	EE	1980
89	Gaurav Rastogi	United States	B.Tech	EE	1998
90	Pankaj Desai	United States	B.Tech	CHE	1974
91	Rajat Verma	India	B.Tech	AE	1998
92	Shamik J Mehta	United States	B.Tech	EE	1977
93	Vikram Narasimhan	United States	MSc5	CHM	1984
94	Dhiraj Kumar	United States	MSc5	MTH	2006
95	Gaurav Mudgal	United Kingdom	MSc5	MTH	2002
96	Nalini Murdter	United States	MSc2	CHM	1979
97	Pankaj Jalote	India	B.Tech	EE	1980
98	Rahul Tomar	United States	B.Tech	ME	1994
99	Bharat Kalyanpur	United States	B.Tech	CSE	1989
100	R Shankar	India	B.Tech	EE	1999
101	Rahul Singh	India	B.Tech	ME	1998
102	Tushar Singh	India	B.Tech	CHE	1994
103	Venkatraman Krishnan	Canada	B.Tech	EE	1975
104	Dhiren Marjadi	United States	B.Tech	ME	1978
105	Alok Kumar Rathi	India	B.Tech	ME	1974
106	Amit Nagpal	United States	B.Tech	ME	1998
107	Anil Mahadeo Deorukhkar	India	B.Tech	ME	1975
108	Aparna Dar	India	MSc5	MTH	1980
109	Arvind Agarwal	India	MSc5	CHM	1975
110	Gurupad Pavan	India	B.Tech	MME	1999
111	Jatin Misra	United States	B.Tech	CHE	1998
112	Jitendra Pandey	United States	B.Tech	EE	1999
113	Vijay Kumar Jain	India	B.Tech	EE	1970

114	Kshitij Gupta	India	B.Tech	CSE	1999
115	Madusoodanan Janardanan Pillai	Singapore	B.Tech	ME	1975
116	Sudhakar Yarlagadda	United States	B.Tech	CHE	1980
117	Namit Agarwal	India	B.Tech	CE	1994
118	Nirjhar Gupta	India	B.Tech	CHE	1991
119	Pankaj Agarwal	India	B.Tech	CE	1998
120	Pooja Agarwal	India	B.Tech	CE	1998
121	Pradip	India	B.Tech	MME	1975
122	Prakash Mohan	Bahrain	B.Tech	CHE	1988
123	Praneet Kumar	India	B.Tech	ME	1998
124	Prashasta Seth	India	B.Tech	MME	1997
125	Pravin Tandon	United Kingdom	B.Tech	CHE	1980
126	Puneet Singhal	India	B.Tech	CHE	1999
127	Rajeev Ranjan	United States	B.Tech	EE	1998
128	Sanjay N. Trivedi	India	B.Tech	CHE	1975
129	Sharat Bansal	India	B.Tech	ME	1975
130	Shekher Agarwal	India	B.Tech	ME	1975
131	Vidya Sagar Narang	United States	B.Tech	EE	1965
132	Ajay Singh	United States	B.Tech	EE	1980
133	Anil Khatri	United States	B.Tech	EE	1980
134	Bhadrayu J Trivedi	United States	B.Tech	EE	1974
135	Bharat Kumar Bhargava	United States	B.Tech	ME	1965
136	Biplab Sinha	United Kingdom	B.Tech	CSE	1994
137	Gaurav Shukla	United States	B.Tech	ME	1999
138	Gautam Khanna	India	B.Tech	ME	1988
139	Kartik Venkat	United States	B.Tech	EE	2010
140	Nishant Sunny	United States	B.Tech	CSE	2016
141	Pradeep Jotwani	United States	B.Tech	ME	1988
142	Rahul Aggarwal	United States	B.Tech	CHE	1999
143	Rajeeva Lahri	United States	MSc2, M.Tech	PHY, MME	1974, 1976
144	Sanjay Mittal	United States	B.Tech	EE	1975

145	Sanjit Sengupta	United States	B.Tech	AE	1980
146	Satyajit Verma	United States	B.Tech	CHE	1974
147	Shantanu Nigam	United States	B.Tech	MME	1998
148	Sheo Kumar Jha	United States	B.Tech	EE	1994
149	Srikanth Ranganathan	United States	B.Tech	ME	1989
150	Surendra Srivastava	India	B.Tech	MME	1999
151	Vikas Khandelwal	United States	B.Tech	EE	1996
152	Abhay Bhushan	United States	B.Tech	EE	1965
153	Mukul Sharma	India	B.Tech	CHE	1980
154	Alok Saboo	India	B.Tech	CHE	1980
155	Anand Shukla	United States	B.Tech	ME	1999
156	Anupam Saronwala	India	B.Tech	EE	1980
157	Aruna Rajeev Savant	India	B.Tech	CHE	1974
158	Ashutosh Lawania	India	B.Tech	MME	1999
159	Ashutosh Nandan	Singapore	B.Tech	ME	1999
160	Ashwani Chaddha	United States	B.Tech	EE	1965
161	Chandra M. Srivastava	United States	B.Tech	CHE	1965
162	Deepak Baranwal	India	B.Tech	EE	1999
163	Deepak Raj Divan	United States	B.Tech	EE	1975
164	Geetika Goel	India	MSc2	MTH	1996
165	Gurmukh D. Mehta	United States	M.Tech	ME	1969
166	Kishore Gogia	India	B.Tech	ME	1976
167	Manas Tandon	India	B.Tech	EE	1998
168	N. P. Krishnan	United States	B.Tech	ME	1972
169	Neeraj Kant	India	B.Tech	CHE	1985
170	Pawan Kumar Mishra	United States	MSc5	MTH	1999
171	Pradeep Kumar Sood	United States	B.Tech	EE	1974
172	Pramod Singh	United States	B.Tech	CHE	1980
173	Pratap Narain Misra	United States	B.Tech	ME	1965
174	Rahul Dev	United States	B.Tech	EE	1999

175	Rajendra Harilal Shah	India	B.Tech	CHE	1974
176	Sachin Maheshwari	India	B.Tech	CSE	1998
177	Sharad Kumar	United States	B.Tech	CHE	1980
178	Shiv Raj Kathpalia	United States	B.Tech	EE	1974
179	Shri Bali	United States	B.Tech	ME	1965
180	Subhendu Lahiri	United States	B.Tech	ME	1980
181	Ajay Rooma Dubey	India	CHE	B.Tech	1980
182	Sunil Bhupendra Patel	United States	B.Tech	ME	1975
183	Sushil Kumar Bansal	United States	B.Tech	ME	1965
184	Vinayak Eswaran	India	B.Tech	ME	1980
185	Aasheesh Mittal	United States	B.Tech	ME	1998
186	Akalank Hirachand Killedar	India	M.Tech	EE	1975
187	Aloke Guha	United States	B.Tech	EE	1980
188	Amit Kumar Singh	India	B.Tech	EE	1999
189	Amitabh Bhattacharya	India	B.Tech	ME	1999
190	Anil Kelkar	India	B.Tech	CHE	1975
191	Arun R Garg	United States	B.Tech	EE	1985
192	Ashish Goel	United States	B.Tech	CHE	1994
193	Bharat Jhaveri	United States	B.Tech	CHE	1974
194	Bhaskar Bhattacharya	Oman	B.Tech	CHE	1978
195	Chirdeep Gupta	United States	B.Tech	EE	1998
196	Deepak Sharma	India	MSc5	MTH	2001
197	Divya Singh	Netherlands	B.Tech	CHE	1994
198	Dungara Ram	United States	B.Tech	CSE	2006
199	Faizan Raza	India	MSc5	CHM	2000
200	Gur Prasad Nayyar	India	B.Tech	EE	1980
201	Ishwar Chandra Agarwal	India	B.Tech/ M.Tech	CE	1965, 1968
202	Josyula Rao	United States	B.Tech	EE	1984
203	Kishor Jhalaria	India	B.Tech	CHE	1979
204	Madhukar Dewan	India	B.Tech	CHE	1974
205	Mahesh Kumar Rawtani	India	B.Tech	EE	1971

206	Manish Lohani	United States	B.Tech	EE	1998
207	Manisha Kulshrestha	United States	B.Tech	EE	1993
208	Mr Nagendra Rao	Belgium	B.Tech	ME	1980
209	Nirjhar Srivastava	United States	B.Tech	ME	1998
210	Pradeep Kumar Mittal	India	B.Tech	ME	1970
211	Pramod Bansal	United States	B.Tech	ME	1965
212	Raja Banerjea	United States	B.Tech	EE	1991
213	Rajiv Mathur	United States	MSc2	PHY	1976
214	Sanjay Bhardwaj	United States	B.Tech	EE	1985
215	Sanjay Garg	United States	B.Tech	AE	1980
216	Sankaranarayanan Veeraraghavan	India	B.Tech	CHE	1975
217	Saurabh Verma	India	B.Tech	EE	1999
218	Shashank Shukla	Singapore	B.Tech	CE	1998
219	Shashwat Kumar	Singapore	B.Tech	MME	1999
220	Shiv Agarwal	United States	B.Tech	EE	1998
221	Shreekant Date	Canada	B.Tech	ME	1974
222	Sunil Srivastava	United States	B.Tech	EE	1980
223	T. V. Sriram	United States	B.Tech	EE	1973
224	Tapan Prasad Bagchi	India	B.Tech	ME	1967
225	Uday B Desai	India	B.Tech	EE	1974
226	Uday Mahagaokar	United States	B.Tech	CHE	1970
227	Vindhya Ramachandran	United States	MSc5	PHY	1994
228	Vineet Dwivedi	India	B.Tech	MME	1999
229	Abbas Ali Kurawarwala	United States	B.Tech	ME	1986
230	Abhijeet Srivastava	India	B.Tech	CHE	2003
231	Abhinav Kumar	India	B.Tech	CSE	2020
232	Abhishek Gupta	India	B.Tech	AE	2007
233	Abhishek Kansal	United States	B.Tech	EE	1998
234	Abhishek Mishra	India	B.Tech	EE	2024
235	Abhishek Ravi	India	B.Tech	CHE	2001
236	Abhoy Kumar Ojha	India	B.Tech	ME	1985

237	Ajoy Bhatia	United States	B.Tech	EE	1989
238	Alok Joshi	India	B.Tech	CHE	1980
239	Alok Kumar	India	B.Tech/M.Tech	ME	1972, 1976
240	Alok Shukla	India	B.Tech/M.Tech	MME	1974, 1978
241	Amber Yunus	United States	B.Tech	AE	1974
242	Ambuj Kumar	United States	B.Tech	EE	2002
243	Amit Gaurav	India	B.Tech	CSE	2007
244	Amit Pharkya	United States	B.Tech	MME	1998
245	Amitabh Misra	India	B.Tech	CHE	1995
246	Amitava Bhattacharya	United States	B.Tech	CHE	1980
247	Amrita Tripathi Sheikh	India	MSc2/P.hd	CHM	1978, 1984
248	Anand Kumar Gupta	India	B.Tech/M.Tech	CE	1999, 2000
249	Anchal Jatale	United States	B.Tech	CHE	2007
250	Anil Malhotra	India	B.Tech	MME	1974
251	Ankur Rastogi	United States	B.Tech	CHE	1999
252	Anshuman Sinha	India	B.Tech	EE	2005
253	Anup Mullick	United States	B.Tech	EE	1972
254	Anupam Kumar Tripathi	India	B.Tech	ME	1999
255	Anuradha Jagannathan	France	MSc5	PHY	1980
256	Arun Tripathi	United States	MSc5	PHY	1990
257	Arvind Jain	India	B.Tech	MME	1974
258	Arvind Kumar Srivastav	United States	B.Tech	EE	1967
259	Ashok Dandekar	United States	B.Tech	ME	1975
260	Ashok Jhunjunwala	India	B.Tech	EE	1975
261	Ashutosh Bisht	India	B.Tech	EE	1999
262	Ashutosh Goel	India	B.Tech	ME	1990
263	Ashutosh Gupta	United States	B.Tech	MME	1998
264	Ashutosh Rohatgi	India	B.Tech	MME	1996
265	Asim Jafa	Spain	B.Tech	CHE	1980
266	Atul K. Mathur	United States	B.Tech	ME	1984
267	Avadhesh Kumar Nigam	United States	B.Tech	ME	1965

268	Avanidhar Subrahmanyam	United States	B.Tech	AE	1984
269	Bakulesh Dahyabhai Parikh	India	B.Tech	CHE	1975
270	Bharat Desai	United States	B.Tech	ME	1980
271	Bhaskar Narayan Basu	India	B.Tech	ME	1996
272	Bhaskar Pramanik	India	B.Tech	EE	1972
273	C Venkobachar	India	M.Tech/P.hd	CE	1969, 1975
274	Chandra Shekhar Soni	India	B.Tech	ME	2008
275	Deepak Aggarwal	India	MSc5	CHM	1995
276	Deepak Bisht	United States	B.Tech	AE	1990
277	Dev Joneja	United States	B.Tech	ME	1984
278	Devanshu Kumar Verma	United States	BT-MT(Dual)	CSE	2008
279	Dhananjay Gurjar	Australia	B.Tech	EE	1975
280	Dinesh Gurnani	India	B.Tech	CSE	2007
281	Dinesh Vallabhdas Valia	India	B.Tech	ME	1975
282	Dr Rajendra Kumar Agarwal	India	B.Tech	AE	1975
283	Durga Choudhury	United States	MSc5	PHY	1991
284	Girish Vishwanath Bhat	United States	B.Tech	EE	1985
285	Gora Sengupta	Australia	B.Tech	EE	1974
286	Gour Prasad Mishra	India	B.Tech	EE	1985
287	Goutam Mitra	United States	B.Tech	AE	1975
288	Gyanesh Chaudhry	India	B.Tech	EE	1966
289	Hemant Goel	United States	B.Tech	ME	1985
290	Imtiyaz Ahmed	India	B.Tech	ME	1990
291	Jaideep Arora	India	B.Tech	EE	1990
292	Jayram Subrahmanian	India	B.Tech	EE	1974
293	Kamlesh Kumar Malhotra	India	B.Tech	CHE	1969
294	Karan Gupta	United States	B.Tech	MME	1965
295	Keshav Sharma	India	B.Tech	CSE	1983
296	Khagesh Maheshwari	Australia	B.Tech	CHE	1974
297	Kirit Shah	India	B.Tech	CHE	1972
298	Kishore Kumar Raiswal	India	B.Tech	CSE	1999

299	Krishnan Vishwanath	United States	B.Tech	EE	1975
300	Kurien Mathew	India	B.Tech	AE	1972
301	Kush Shah	India	B.Tech	CHE	2007
302	Luvish Satija	India	B.Tech	CSE	2007
303	Madhav Mavalankar	India	B.Tech	ME	1975
304	Manish Kumar Shukla	United States	B.Tech	EE	1999
305	Manish Kumar Singh	India	B.Tech	CE	1992
306	Manish Misra	India	B.Tech	ME	2001
307	Manoj Ranjan	India	M.Tech	ME	2005
308	Mayank Agarwal	India	B.Tech	EE	2007
309	Mridul Barsaiyan	Singapore	B.Tech	CSE	2007
310	Neeraj Jain	India	B.Tech/ M.Tech	CE	1978, 1981
311	Neeraj Mathur	Canada	MSc5	STAT	1999
312	Nidhi Agarwal	India	M.Tech	EE	2008
313	Niraj Kumar Prasad	United States	B.Tech	ME	1989
314	Nitesh Kekre	India	B.Tech	EE	1998
315	Nitin Agarwal	India	B.Tech	EE	2001
316	Obulampalli Kiran Kumar	India	M.Tech	EE	2005
317	Om Kumar	India	B.Tech	ME	1999
318	Pankaj Kumar	United States	B.Tech	CSE	1989
319	Paras Mittal	India	B.Tech	CSE	2022
320	Pawan Kumar	India	B.Tech	CHE	1999
321	Pinakin Jaradi	United States	B.Tech	ME	1972
322	Prabhat Kumar Dalmia	United States	B.Tech	CHE	1999
323	Prabhat Singh	India	B.Tech	CE	1980
324	Pradeep Koppikar	India	B.Tech	CHE	1974
325	Pradeep Kumar	India	B.Tech	ME	1974
326	Prashant Kumar Jain	India	B.Tech	ME	1989
327	Pratyush Kumar Prasoon	India	B.Tech	EE	1999
328	Praveen Rawat	India	B.Tech	CHE	2001
329	Priyansh Dixit	India	B.Tech	ME	1999

330	Probhat Kapur	United States	B.Tech	CHE	1986
331	Pushpinder Kumar Sharda	India	B.Tech	EE	1972
332	Rabikar Chatterjee	United States	B.Tech	CHE	1972
333	Rachna Pradhan	India	B.Tech	EE	1985
334	Raghavendra Dikshit	India	B.Tech	ME	1999
335	Rahul Gautam	India	B.Tech	CHE	1975
336	Rahul Jindal	United States	B.Tech	EE	1985
337	Rahul Kumar Jha	India	B.Tech	EE	2009
338	Rahul Mishra	India	B.Tech	CSE	2000
339	Rahul Pandey	India	B.Tech	ME	1999
340	Rahul Shukla	India	B.Tech	EE	1999
341	Raj Maheshwari	Canada	B.Tech	CHE	1965
342	Rajendra Vishwanath Kulkarni	India	B.Tech	EE	1985
343	Rajesh Gopakumar	India	MSc5	PHY	1992
344	Rajinder Singh Dhillon	India	B.Tech	EE	1972
345	Rajiv Sinha	India	B.Tech	ME	1972
346	Rakesh Gandhi	United Kingdom	B.Tech	EE	1972
347	Raman Kumar	India	B.Tech	EE	1994
348	Ramesh Chandra Dwivedi	United States	B.Tech	EE	1968
349	Ramesh Gupta	India	B.Tech	ME	1972
350	Rangarajan Vellamore	India	B.Tech	ME	1990
351	Ravi Khanna	United States	B.Tech	CHE	1967
352	Ravi Prakash	India	B.Tech	EE	1994
353	Ravi Shukla	United States	B.Tech	ME	1980
354	Ravinder Reddy	India	Ph.D	CHM	1988
355	Ravindra Bhagwat	India	B.Tech	CHE	1974
356	Ravindra D Kale	India	B.Tech	ME	1965
357	Roli Wendorf	United States	B.Tech/ M.Tech	EE	1976, 1979
358	Sachal Mahajan	Canada	MSc5	PHY	1999
359	Saketh Ginuga	India	B.Tech	CSE	2019
360	Sandeep Sharma	United States	B.Tech	EE	1999

361	Sandeep Tucknat	United States	B.Tech	EE	1999
362	Sanjay Chawla	India	B.Tech	ME	1998
363	Sanjay Kumar Srivastava	United States	B.Tech	EE	1985
364	Sateesh Kumar Rajput	Canada	B.Tech	CHE	1980
365	Saurabh Goel	India	B.Tech	EE	1990
366	Saurabh Jain	India	B.Tech	EE	1999
367	Shailendra Krishna	United States	M.Tech	EE	2017
368	Sharad Vipin Dalal	India	B.Tech	CHE	1975
369	Shashank Sinha	India	B.Tech	ME	1998
370	Shiam Sunder Gupta	Canada	B.Tech	ME	1965
371	Shiv Shankar Bajpayi	India	B.Tech	ME	1998
372	Shrey Shahi	United States	B.Tech	CE	2007
373	Som Deo Upadhyay	India	B.Tech	ME	1980
374	Somya Iyer	India	MSc5	CHM	2000
375	Sridhar Adibhatla	United States	B.Tech	ME	1976
376	Subhash Bhardwaj	United States	B.Tech	EE	1980
377	Subir Varma	United States	B.Tech	EE	1985
378	Subodh Gupta	India	B.Tech	ME	1996
379	Sudarshan Kumar Kathuria	United States	B.Tech	CHE	1972
380	Suddhasheel Ghosh	India	Ph.D	CE	2013
381	Sudhir Jain	United States	B.Tech	EE	1991
382	Sumedh Wale	India	B.Tech	CSE	1999
383	Sundar Sriram	United States	B.Tech	EE	1989
384	Sunil Bhandari	India	B.Tech	ME	1977
385	Suresh Dattatraya Haridas	India	M.Tech	EE	1970
386	Swapnil Gupta	India	B.Tech	CHE	1998
387	T Punniyamurthy	India	Ph.D	CHM	1995
388	Tanmay Sachan	India	B.Tech	EE	2007
389	Tushar Kasarekar	India	B.Tech	ME	1974
390	V K Sehgal	India	B.Tech	CE	1974
391	Ved Singh	India	M.Tech	IME	1997

392	Vikas Rawat	India	B.Tech	CE	1999
393	Vikas Srivastava	India	B.Tech	CE	1985
394	Vineet Purswani	Singapore	BT-MT(Dual)	CSE	2018
395	Viswanath Mahadevan	India	MSc2	CHM	1995
396	Vivek Mudgil	India	B.Tech/ P.hd	EE	1989, 2003
397	Vivek Naik	India	B.Tech	MME	1982
398	Vivekanand Jha	India	B.Tech	ME	1999
399	Yogesh Singh Chauhan	India	M.Tech	EE	2003
400	Anil Kumar Singh	India	B.Tech	AE	1970

Less than 1 Lakh

S. No.	Donor Name	Country	Program	Department	Year
401	Suhrit Ghosh	India	B.Tech	MME	1975
402	A K Parameshwaran	India	B.Tech	CHE	1985
403	A R Harish	India	Ph.D	EE	1997
404	A V Chaturvedi	India	MSc5	PHY	1980
405	Aakash Verma	India	BT-MT(Dual)	CSE	2016
406	Aayush Mudgal	United States	B.Tech	CSE	2016
407	Aayush Puri	United States	B.Tech	CSE	2005
408	Aayush Vishnoi	India	B.Tech	ME	2007
409	Abdul Majid	India	B.Tech	ME	1973
410	Abhay Gupta	Canada	B.Tech	CHE	1999
411	Abhay Maheshwari	India	B.Tech	ME	1985
412	Abhay Tayal	India	B.Tech	EE	1980
413	Abhijit Manna	India	Ph.D	CHM	2024
414	Abhinandan Jain	United States	B.Tech	EE	1978
415	Abhinav Agarwal	United States	B.Tech	EE	2006
416	Abhinav Mittal	United States	B.Tech	CHE	1999
417	Abhiroop Bhatnagar	India	BT-MT(Dual)	EE	2015
418	Abhishek Akhilesh Shukla	India	M.Tech	ME	2024
419	Abhishek Dey	India	MSc2	CHM	2001
420	Abhishek Goyal	India	B.Tech	ME	1995

421	Abhishek Jain	India	MSc5	MTH	2008
422	Abhishek Nigam	Japan	B.Tech	CHE	1999
423	Abhishek Pandey	United States	B.Tech	CHE	1999
424	Abhishek Sharma	India	MBA	IME	2010
425	Abhishek Srivastava	India	B.Tech	CE	2007
426	Abhishek Tewari	India	B.Tech- M.Tech	MME	2007, 2009
427	Adarsh Chauhan	United States	BT-MT(Dual)	CSE	2016
428	Adishesha Misra	India	B.Tech	CE	1985
429	Aditya Bhutra	United Kingdom	B.Tech	CSE	2016
430	Aditya Khanna	India	B.Tech	ME	2007
431	Aditya Narayan Panda	India	Ph.D	CHM	2004
432	Ajay Dubey	India	B.Tech	CHE	1980
433	Ajay Garg	India	B.Tech	CHE	1985
434	Ajay Jain	United States	B.Tech	EE	1970
435	Ajay Jangid	India	B.Tech- M.Tech	EE	1999, 2002
436	Ajay Kumar	United States	Ph.D	AE	1974
437	Ajay Sharma	India	B.Tech	ME	1985
438	Ajit Gunvantrai Vashi	United States	B.Tech	CHE	1974
439	Ajit Kumar Chaturvedi	India	B.Tech- M.Tech- Ph.d	EE	1986, 1988, 1995
440	Ajitabh Ranjan	United States	B.Tech	AE	1989
441	Akarsh Mittal	India	BT-MS(Dual)	CE-ECO	2023
442	Akash Anand	United States	MSc5	MTH	2000
443	Akash Bhargav	India	M.Tech	ME	2024
444	Akash Kumar Bhoi	India	B.Tech	CSE	2023
445	Akhila Nanjala	United States	MSc5	ECO	2015
446	Akhilendra Chauhan	United States	B.Tech	CE	2001
447	Akhilesh Maewal	United States	B.Tech	ME	1970
448	Akhilesh Sharma	India	B.Tech	CSE	2022
449	Akshar Bhatnagar	India	BS	MTH-STAT	2019
450	Akshay Kumar Prasad	India	M.Tech	MSE	2024

451	Akshay Mahajan	India	B.Tech	CHE	2016
452	Akshaya Singh Katihar	India	B.Tech	AE	2007
453	Alok Jha	Saudi Arabia	B.Tech	ME	1989
454	Alok Kumar Mathur	India	B.Tech	MME	1969
455	Alok Ranjan	India	B.Tech	MME	1975
456	Alok Sharan	United States	B.Tech	MME	1989
457	Alok Singhal	United States	B.Tech	EE	1999
458	Alok Srivastava	United Kingdom	B.Tech	CHE	1980
459	Alok Tomar	India	BT-MT(Dual)	CE	2010
460	Aloke Prasad	India	B.Tech	ME	1980
461	Alpana Dubey	India	Ph.D	CSE	2007
462	Amarendra Kumar Singh	India	B.Tech	MME	1987
463	Amarsh Chaturvedi	India	B.Tech	CE	2007
464	Ambarish Chatterjee	India	B.Tech	ME	1980
465	Ambrish Mathur	United States	B.Tech- M.Tech	CHE	1976
466	Amey Karkare	India	B.Tech	CSE	1998
467	Amit	United States	B.Tech	ME	1999
468	Amit Jain	India	B.Tech	MME	2007
469	Amit Kumar	India	B.Tech	MME	1985
470	Amit Kumar Das	India	B.Tech	EE	1999
471	Amit Mitra	India	MSc2-Ph.d	STAT	1991, 1996
472	Amit Ranjan	India	BS	MTH	2018
473	Amit Rastogi	India	B.Tech	EE	1993
474	Amit Srivastava	United States	B.Tech	EE	2001
475	Amitava Biswas	Thailand	B.Tech	EE	1985
476	Amod Singhal	United States	B.Tech	AE	1980
477	Amogh Dikshit	India	B.Tech	ME	2007
478	Anand Jagannathan	United States	B.Tech	EE	1974
479	Anand Khandelwal	India	B.Tech	CHE	2018
480	Anand Mehta	India	M.Tech	CE	2011

481	Anand Verma	India	BT-MT(Dual)	ME	2008
482	Anant Mundra	India	B.Tech	CE	2014
483	Anant Narayan Vats	India	B.Tech	CSE	2019
484	Ananta Mukerji	United States	B.Tech	EE	1980
485	Anil Agarwal	India	B.Tech	CHE	1974
486	Anil Jha	United States	B.Tech	CSE	1984
487	Anil Kavitkar	India	B.Tech	ME	1967
488	Anil Kumar Bhala	United States	B.Tech	ME	1973
489	Anil Kumar Jha	India	B.Tech	EE	1970
490	Anil Kumar Nikhra	India	B.Tech	EE	1999
491	Anil Kumar Singh	India	B.Tech	AE	1970
492	Anil Ramkrishna Nerurkar	United States	B.Tech	EE	1977
493	Anil Varma	India	B.Tech	ME	1991
494	Animangsu Ghatak	India	M.Tech	CHE	1998
495	Animesh	India	B.Tech	EE	1999
496	Anjali V Kulkarni	India	M.Tech	EE	2001
497	Ankesh Kumar Thakur	India	B.Tech	BSBE	2014
498	Ankit Hoshing	India	B.Tech	CHE	2007
499	Ankit Singh Rawat	United States	B.Tech	EE	2010
500	Ankur Bhagat	India	M.Tech	ME	2007
501	Ankur Gupta	United States	B.Tech	EE	2005
502	Ankush Kumar	United Arab Emirates	MSc5	MTH	2015
503	Anoop Kishore Talwar	India	B.Tech	ME	1972
504	Anoop Mishra	United States	B.Tech	CSE	1999
505	Anoop Swarup	United States	B.Tech	EE	1970
506	Anshu Gaur	India	M.Tech	MME	2001
507	Anshul Gandhi	United States	B.Tech	CSE	2007
508	Anu Khandwal	India	MSc5	MTH	2015
509	Anu Tripathi	United States	BT-MT(Dual)	CE	2015
510	Anubha Goel	India	M.Tech	EEM	2001

511	Anubhav Garg	India	B.Tech	CHE	2007
512	Anuj Kumar Singh	India	B.Tech	AE	2007
513	Anupreet Porwal	United States	BS-MS(Dual)	MTH	2017
514	Anurag Bhatnagar	United States	B.Tech	EE	1985
515	Anurag Bhatt	India	B.Tech	ME	2008
516	Anurag Kumar	India	MSc5	CHM	2017
517	Anurag Mehrotra	India	B.Tech	CE	1985
518	Anurag Tripathi	United States	B.Tech	ME	2004
519	Anuraj Singh	India	B.Tech	ME	2024
520	Apurva Prakash	India	B.Tech	ME	1999
521	Aravind	India	MS-R	EE	2024
522	Arihant Bhandari	India	B.Tech-Ph.d	ME	2013, 2020
523	Arin Kanchan	India	B.Tech	ME	2024
524	Arindam Choudhury	India	B.Tech	EE	1999
525	Arko Das	India	Ph.D	CHM	2022
526	Arun Jain	India	B.Tech	EE	2007
527	Arun Kumar	India	B.Tech	EE	1985
528	Arun Kumar Saha	India	M.Tech-Ph.d	ME	1994, 1999
529	Arun Kumar Srivastava	India	B.Tech	EE	1973
530	Arun Narayan Kulkarni	India	B.Tech	ME	1974
531	Arun Pal Aneja	United States	B.Tech	CHE	1970
532	Arun Seth	India	B.Tech	EE	1973
533	Arvind Bansal	United States	B.Tech- M.Tech	EE	1979, 1983
534	Arvind Bhatia	India	B.Tech	CHE	1985
535	Arvind Krishna	United States	B.Tech	EE	1985
536	Arvind Kumar Goel	India	B.Tech	CE	1982
537	Arvind Kumar Sinha	India	B.Tech	ME	1990
538	Asad Zaidi	United Arab Emirates	B.Tech	MME	1989
539	Asheesh Kumar Gupta	India	B.Tech	EE	1989
540	Asheesh Shukla	India	BT-MT(Dual), Ph.d	CHE	2008, 2018

541	Ashish Anand	India	B.Tech	MME	1999
542	Ashish Anand Gupta	India	B.Tech	CHE	1990
543	Ashish Asthana	United States	B.Tech	MME	1985
544	Ashish Bansal	United States	MSc5	CHM	1990
545	Ashish Juneja	Australia	B.Tech	EE	1999
546	Ashish Kumar	India	B.Tech	CHE	1995
547	Ashish Kumar Patel	India	B.Tech	EE	2015
548	Ashish Kumar Srivastava	India	B.Tech	CE	1996
549	Ashish Sabharwal	United States	B.Tech	CSE	1998
550	Ashish Singhal	India	B.Tech	MME	1999
551	Ashish Singru	India	B.Tech	MME	1989
552	Ashish Srivastava	India	B.Tech	CE	1996
553	Ashish Tiwari	United States	M.Tech	IME	1995
554	Ashish Ujwal	India	B.Tech	CSE	2003
555	Ashish Varshney	United States	B.Tech	CE	1999
556	Ashok Khanna	India	B.Tech- M.Tech- Ph.d	CHE	1969, 1972, 1990
557	Ashok Kumar	India	B.Tech	EE	1980
558	Ashok Kumar Singh	India	B.Tech	AE	1970
559	Ashok Manglik	India	B.Tech	EE	1970
560	Ashutosh Pathak	India	BT-MT(Dual)	CSE	2009
561	Ashutosh Sharma	India	B.Tech	CHE	1982
562	Ashwani Rawat	India	B.Tech	CE	2007
563	Asim Shukla	India	B.Tech	CHE	1969
564	Asmita Gupta	India	MSc5	MTH	2015
565	Athonu Chatterjee	United States	B.Tech- M.Tech	ME	1992, 1994
566	Atul	India	B.Tech	AE	2022
567	Atul Behari Bhatnagar	India	B.Tech	ME	1985
568	Atul Bhaskar	United Kingdom	B.Tech	ME	1989
569	Atul Dikshit	India	B.Tech	ME	1989
570	Atul Gosalia	United States	B.Tech	EE	1974
571	Atul Goyal	United States	B.Tech	ME	1980

572	Atul Jain	India	B.Tech	CE	2007
573	Avatar Saran	India	B.Tech	MME	1966
574	Avinash Giri	India	B.Tech	EE	1970
575	Avinash K Gautam	India	B.Tech	EE	1989
576	Avinash Misra	United States	B.Tech	CE	1999
577	Aviral Jain	India	B.Tech	EE	2010
578	Avish Rana	India	BT-MT(Dual)	AE	2015
579	Awanish K. Awasthi	India	B.Tech	EE	1985
580	Ayush Aggarwal	India	B.Tech	CE	2016
581	Ayush Raj	India	B.Tech	CHE	2024
582	B Pareek	India	MSc5	MTH	2008
583	Bal Krishn Birla	India	B.Tech	CSE	1995
584	Barath Palanisamy	United States	M.Tech	MME	2007
585	Barun Kumar	India	B.Tech	ME	1992
586	Beharji Charity Trust	India	B.Tech	CHE	1990
587	Bhabananda Nath	India	B.Tech	CE	1986
588	Bhaskar Roy	India	B.Tech	MME	1969
589	Bhupesh Chandra	United States	B.Tech	CSE	2007
590	Bhupinder Magan	India	B.Tech	CE	1980
591	Bhushan Kumar	India	B.Tech	AE	1995
592	Bibek Singh	India	MSc5	MTH	2000
593	Bijoy Bordoloi	United States	B.Tech	CSE	2001
594	Binay Kumar Chaudhary	Germany	B.Tech	EE	1990
595	Binit Kumar	India	B.Tech	MME	2007
596	Birendra Bisht	India	B.Tech	MME	1999
597	Biswapesh Chattopadhyay	United States	B.Tech	CHE	1996
598	Braj Bhushan	India	B.Tech	ME	1999
599	Brijesh Kumar Mishra	India	MSc5-Ph.d	CHM	2003, 2008
600	Chandan Kumar	India	B.Tech	EE	1999
601	Chandan Singh	India	B.Tech	MME	2008
602	Chander Mohan Puri	India	B.Tech	EE	1970

603	Chandra Bhushan	India	B.Tech	CE	2001
604	Chandra Shekhar Kumar	India	MSc5	PHY	2000
605	Chandrashekhar D Naik	United States	B.Tech	CHE	1980
606	Charanjit S Jutla	United States	B.Tech	CSE	1985
607	Charanpreet Singh	India	B.Tech	ME	1985
608	Chavi Jain	India	B.Tech	MSE	2014
609	Chetan Jain	India	B.Tech	MME	2009
610	Chowdary Koripella	United States	M.Tech	MME	1981
611	D Venkatramana Reddy	India	M.Tech	CSE	2003
612	Damnish Kumar	India	MSc5	MTH	2000
613	Debabrata Goswami	India	MSc2	CHM	1988
614	Debarghya Jana	India	MSc2	STAT	2024
615	Debjani Das	India	M.Tech	BSBE	2024
616	Deepa Sahchari	India	MSc5	MTH	2014
617	Deepak Bhagat	United States	B.Tech	EE	1973
618	Deepak Gupta	India	B.Tech	MME	1987
619	Deepak Jain	India	B.Tech	EE	1990
620	Deepak Kumar Saxena	India	M.Tech	IME	2008
621	Deepanshu Arora	India	BT-MT(Dual)	EE	2011
622	Deeptanshu Shukla	Japan	B.Tech	CSE	2007
623	Devanshu Arya	Netherlands	BT-MT(Dual)	EE	2015
624	Deven Shah	United States	MSc5	STAT	1991
625	Devendra Agarwal	India	B.Tech	CSE	2015
626	Devendra Singh	United States	B.Tech	EE	1985
627	Devendra Tripathi	United States	M.Tech	EE	1986
628	Devesh Kumar Srivastava	India	B.Tech- M.Tech	CE	1986, 1990
629	Devesh Tiwari	United States	B.Tech	CSE	2007
630	Dhairya Shrivastava	United States	B.Tech	ME	1985
631	Dhanraj K Chokappa	India	B.Tech	CHE	1982
632	Dhiren Marjadi	United States	B.Tech	ME	1978
633	Dhirendra Bahuguna	India	Ph.D	MTH	1989

634	Dhirendra Tripathi	India	B.Tech	AE	1988
635	Dilip Ernest Williams	India	B.Tech	EE	1970
636	Dilip Koshy	United Arab Emirates	B.Tech	CHE	1974
637	Dinesh Godara	India	B.Tech	MSE	2014
638	Dinesh Kumar	India	B.Tech	AE	1995
639	Dipak Mazumdar	India	M.Tech	MME	1982
640	Dipayan Mitra	India	B.Tech	CHE	1991
641	Dipen Sheth	India	B.Tech	CHE	1989
642	Dipendra Sharma	India	B.Tech	ME	2007
643	Diwaker Gupta	United States	B.Tech	CSE	2003
644	Durga Shanker Mishra	India	B.Tech	EE	1983
645	Emil Abraham	India	M.Tech	CSE	2013
646	Farman Memon	India	BT-MT(Dual)	ME	2015
647	G Sekar	India	Ph.D	CHM	2000
648	G. Neelakantan	India	Ph.D	HSS	1989
649	Gajendra Singh	India	B.Tech	EE	1969
650	Ganesh Neema	India	M.Tech	ME	2005
651	Garima Joshi	United States	B.Tech	MME	2008
652	Gaurav Agarwal	United States	B.Tech	EE	1999
653	Gaurav Kumar	India	B.Tech	AE	2007
654	Gaurav Mathur	India	B.Tech	CHE	1989
655	Gaurav Nigam	United States	B.Tech	EE	2009
656	Gaurav Raizada	India	B.Tech	CHE	2003
657	Gaurav Sharma	United States	B.Tech	CE	1999
658	Gautam Pratap Singh	India	B.Tech	ME	2016
659	Girdhar Gupta	Singapore	B.Tech	MME	1999
660	Giresh Kumar Singh	India	B.Tech- M.Tech- Ph.d	AE	1989, 1991, 2000
661	Girish Kumar	India	B.Tech	CE	1989
662	Girish M	India	M.Tech	EE	2003
663	Girja Prasad	United States	B.Tech	ME	1974
664	Goutam Mandal	India	M.Tech	MSE	2015

665	Goutham Konduru	India	B.Tech	CSE	2017
666	Govind Saria	India	B.Tech	EE	2014
667	Guneet Sethi	India	B.Tech	MME	2003
668	Gyan Prakash Pandey	India	B.Tech	ME	1965
669	H N Ramaswamy	India	Ph.D	MTH	1982
670	H Sushruth	India	B.Tech	EE	2015
671	Hardik Patel	United States	BT-MT(Dual)	CSE	2012
672	Hare Krishna	India	B.Tech	CE	1999
673	Hari Krishan Mehrotra	India	B.Tech	CHE	1969
674	Harish Rupakula	India	M.Tech	CE	1994
675	Harishwar Dayal	India	B.Tech	EE	1980
676	Harmeet Singh	United States	BT-MT(Dual)	CSE	2012
677	Harsh Garg	India	B.Tech	CE	2009
678	Harsh Singh	India	B.Tech	EE	2007
679	Harsh Vinayak	India	B.Tech	ME	1989
680	Harshit Khaitan	India	BT-MT(Dual)	CE	2015
681	Hema Rani P	India	M.Tech	EE	2005
682	Hemant Kumar Gupta	United States	B.Tech	MME	1980
683	Hemant Kumar Singh	Australia	B.Tech	ME	2007
684	Hemant Nagar	India	BT-MT(Dual)	CHE	2020
685	Himanshu Agarwal	United States	B.Tech	MME	1999
686	Himanshu Sharma	United States	BT-MT(Dual)	AE	2009
687	Himanshu Singhal	India	B.Tech	MME	2007
688	Himanshu Tewary	India	B.Tech	ME	2007
689	Himesh Mishra	India	B.Tech	ME	1980
690	Hussaini Alihussain	Kuwait	B.Tech	EE	1990
691	Indra Kumar Jaiswal	India	B.Tech	ME	1980
692	Indrajit Roy	India	B.Tech	CSE	2005
693	Indranil Manna	India	M.Tech	MME	1985
694	Ish Kumar Jain	United States	B.Tech	EE	2016
695	Jacob Thomas	United States	B.Tech	CHE	1985

696	Jagdish Kumar	India	B.Tech	ME	1999
697	Jai Gopal	India	M.Tech	ME	1991
698	Jai Kumar Singh	India	BT-MT(Dual)	CSE	2009
699	Jai P Singh	United Kingdom	B.Tech	EE	1969
700	Jaivrat Singh	Singapore	B.Tech	MME	1999
701	Janardan Prasad Singh	India	Ph.D	PHY	1985
702	Japesh Bandhopadhyay	India	B.Tech	ME	1990
703	Javesh Garg	India	B.Tech	CSE	2015
704	Jawaharlal Prasad	United States	B.Tech	CHE	1979
705	Jayant Kumar Singh	India	B.Tech	CHE	1997
706	Jayant Vishuwanath Kapatver	India	B.Tech	EE	1971
707	Jeetesh Mangwani	India	B.Tech	CSE	2014
708	Jishnu Bhattacharya	India	MSc5	PHY	2013
709	Jitendra Gupta	India	B.Tech	MME	1970
710	Jitendra Kumar	India	B.Tech	CSE	1999
711	Jitendra Meena	India	B.Tech	EE	2019
712	Jitesh Jain	United States	B.Tech	EE	2002
713	Joginder Singh Marwah	Netherlands	B.Tech	CHE	1989
714	John A Gunaraj	United States	M.Tech	AE	1991
715	Joy Bhattacharjee	India	B.Tech	CHE	2013
716	Joy Roy	United States	B.Tech	ME	1980
717	Jyotindra Kumar Keshewani	India	MSc2	PHY	1999
718	Jyotsna Soni	India	B.Tech	CHE	2014
719	K Vinod Kumar	India	M.Tech	EE	1978
720	Kamaleshwar Prasad	India	B.Tech	MME	1985
721	Kamesh R. Aiyer	United States	B.Tech	EE	1974
722	Kamlesh Kumar Srivastava	United States	B.Tech- M.Tech	MME	1969, 1971
723	Kapil Kapur	United Kingdom	B.Tech	EE	1989
724	Kaplesh Kumar	United States	B.Tech	MME	1969
725	Kashyap Dixit	United States	BT-MT(Dual)	CSE	2008
726	Kaushal Kishore Anand	India	B.Tech	ME	1985

727	Kaustav Das Gupta	India	M.Des	DES	2009
728	Kaustubh Chaharia	India	MSc5	CHM	2015
729	Kavery Muthana	United States	B.Tech	EE	1970
730	Khairati Lal Arya	New Zealand	B.Tech	ME	1965
731	Khot Sachin Bhivaji	India	M.Tech	CSE	2009
732	Kirit Lakhani	India	M.Des	DES	2017
733	Kishore Kumar	India	B.Tech	EE	1985
734	Kondru Sivakumar	India	M.Tech	ME	2024
735	Kotha Akshay Kumar Reddy	United States	B.Tech	CHE	2016
736	Krishan Nagpal	United States	B.Tech	CHE	1982
737	Krishna Agrawal	India	B.Tech	ME	2023
738	Krishna Kumar Singh	India	B.Tech	ME	1970
739	Krishna Pal Singh	United States	B.Tech	AE	2007
740	Krishna Prasanth Patnana	Saudi Arabia	M.Tech	CHE	2001
741	Kriti Mohan Ghosh	India	B.Tech	EE	1999
742	Kshitiz Verma	India	B.Tech	CSE	2007
743	Kulbhushan Singh Baghel	India	B.Tech	EE	2007
744	Kuldeep Lonkar	United States	B.Tech	AE	2007
745	Kuldeep Yadav	Netherlands	BT-MT(Dual)	ME	2015
746	Kumar Bintu	India	B.Tech	ME	1999
747	Kumar Brij Mohan Goel	United States	B.Tech	EE	1985
748	Kunal	India	B.Tech	ME	1999
749	Kuram Shashank	India	B.Tech	ME	2024
750	Kushal Srivastava	India	MSc5	PHY	2008
751	Lalit Kumar Das	India	B.Tech	CE	1969
752	Lalji Dwivedi	India	B.Tech	MET	1972
753	Lavisha Aggarwal	United States	B.Tech	EE	2017
754	Lok Ranjan	India	B.Tech- M.Tech	ME	1985, 1987
755	Lokanath Mishra	India	B.Tech	CHE	1994
756	Lokendra Kumar Mehta	United States	B.Tech	ME	2007
757	Lokesh Yadav	United States	B.Tech	EE	2015

758	Lourderaj Upakarasamy	India	Ph.D	CHM	2005
759	M Ahsanul Hoda Ahsan	India	MSc2	PHY	1988
760	M K Harbola	India	MSc5	PHY	1983
761	M S Badari Narayana	United States	B.Tech	EE	1973
762	Madan Gopal Agarwal	India	B.Tech	ME	1974
763	Madhav V Ranganathan	India	Ph.D	ME	2015
764	Madhu Alur	United States	B.Tech	MME	1991
765	Madhur Ambastha	United States	B.Tech	CSE	2003
766	Madhuresh Agrawal	India	BT-MT(Dual)	CSE	2008
767	Madhusudan Jagannathan	United States	B.Tech	MME	2007
768	Mahendra Kumar Yadav	India	B.Tech	ME	1999
769	Mahua Chaudhuri	United States	MSc2	MTH	1999
770	Mamta Bhardwaj	United States	B.Tech	EE	1999
771	Mamta Gill	India	Ph.D	CHM	2024
772	Manas Mandal	United States	B.Tech	CSE	1985
773	Mangal Deo	India	B.Tech	AE	1989
774	Mangal Singh	India	B.Tech	EE	1980
775	Manik Mayur	India	B.Tech	ME	2007
776	Manindra Agrawal	India	B.Tech-Ph.d	CSE	1986, 1992
777	Manish Garg	United States	B.Tech	CHE	1999
778	Manish Goyal	United States	B.Tech	EE	2000
779	Manish Kankani	India	B.Tech	CHE	1999
780	Manish Kumar	India	BT-MT(Dual)	AE	2015
781	Manish Kumar Gupta	India	B.Tech	CE	1998
782	Manish Kumar Saluja	United States	B.Tech	EE	2001
783	Manish Singh Chauhan	India	B.Tech	AE	1999
784	Manish Tiwari	United States	B.Tech	CSE	1999
785	Manohar Lal Rampal	India	B.Tech	EE	1966
786	Manohar Moorthy	India	B.Tech	CSE	1992
787	Manoj Bakshi	India	B.Tech	MME	1989
788	Manoj Jhalani	India	B.Tech	EE	1985

789	Manoj Kumar	India	B.Tech	CE	1999
790	Manoj Srivastava	United States	B.Tech	EE	1989
791	Manu Mittal	India	M.Tech	CE	1999
792	Mayank Gupta	India	B.Tech	CHE	1999
793	Md Saif	India	B.Tech	ME	2023
794	Meeniga Varun	India	MS-R	EE	2024
795	Meghna Singh	India	B.Tech	ME	2023
796	Milind Vasant Talpallikar	United States	B.Tech	AE	1986
797	Mithilesh Jha	India	B.Tech	EE	1985
798	Mohammad Sajid	Saudi Arabia	Ph.D	MTH	2005
799	Mohammed Hasan	India	B.Tech	ME	2023
800	Mohan Arvind Tambe	India	B.Tech- M.Tech	EE	1980, 1983
801	Mohan G	India	M.Tech	EE	2024
802	Mohit Agarwal	Singapore	B.Tech	CE	2011
803	Mohit Kumar	India	B.Tech	ME	2001
804	Mohit Mittal	United States	B.Tech	EE	1996
805	Mohit Shankar Srivastava	India	BT-MT(Dual)	ME	2008
806	Monica Katiyar	India	B.Tech	MME	1987
807	Mukesh Maheshwari	India	B.Tech	CHE	1987
808	Mukesh Sharma	India	M.Tech	CE	1982
809	Mukul Kumar	United States	B.Tech	ME	1974
810	Mukul Sharma	United States	B.Tech	CHE	1980
811	N S Rangunathan	United States	B.Tech	MME	1980
812	N V Subrahmanyam	India	B.Tech	CHE	1990
813	Nakul Surana	India	BS	MTH	2017
814	Naresh Chandra Birla	India	B.Tech	MME	1965
815	Naresh Chandra Jain	India	B.Tech	ME	1973
816	Nataraju N	India	M.Tech	CSE	2005
817	Navdeep Sood	United States	B.Tech- M.Tech	ME	1989, 1994
818	Naveen D	India	B.Tech	ME	2000
819	Navin Gupta	United States	B.Tech	MME	1989

820	Navin Prakash Verma	United States	B.Tech	CE	1999
821	Navpreet Singh	India	B.Tech- M.Tech	EE	1990, 1997
822	Nazish Hoda	United States	B.Tech	CHE	2003
823	Neema Das	India	B.Tech	CHE	1998
824	Neeraj Agarwal	India	B.Tech	CE	1999
825	Neeraj Chandra	India	B.Tech	EE	1980
826	Neeraj Mishra	India	MSc2-Ph.d	STAT	1985, 1991
827	Neerav Verma	United States	B.Tech	MME	2007
828	Neha Sugandh	United States	B.Tech	CSE	2006
829	Neilay Nanji Dehdhia	India	B.Tech	CHE	1989
830	Nidhi Patni	India	BS	ECO	2017
831	Nikesh Chandra	India	B.Tech	CE	1989
832	Nikit Phadke	India	B.Tech	MME	2005
833	Nikunj Agrawal	United States	B.Tech	CSE	2015
834	Nilanjan Karfa	India	B.Tech	ME	1999
835	Nileshkumar Verma	India	M.Tech	EE	2024
836	Nilmani Nilmani	India	B.Tech	CE	1989
837	Nimar Arora	United States	B.Tech	CSE	1996
838	Nimish Sanghi	India	B.Tech	EE	1990
839	Nimit Singhania	United States	B.Tech	CSE	2010
840	Niraj Verma	India	B.Tech	EE	1990
841	Niranjan Srinivas	United States	MSc5	MTH	2008
842	Nishant Mittal	United States	B.Tech	EE	1999
843	Nishant Singh Hada	India	B.Tech	EE	2007
844	Nishith Singh	India	B.Tech	CHE	1999
845	Niskarsh Kumar	India	B.Tech	MSE	2021
846	Nitin Aggarwal	United States	MBA	IME	2015
847	Nitin Bhargava	United States	B.Tech	EE	2000
848	Nitin Gupta	India	B.Tech	CSE	2004
849	Nitin Jain	United States	B.Tech	CE	1999
850	Nitin Kaistha	India	B.Tech	CHE	1996

851	Nitin Mehra	India	MSc5	MTH	2000
852	Nitin Srivastava	India	B.Tech	MME	1994
853	Nitin Vaidya	United States	B.Tech	EE	1989
854	Nitish Sharma	India	B.Tech	EE	2014
855	Om Prakash Kapoor	India	Ph.D	MTH	1966
856	P Nagarajan	United States	B.Tech	CSE	1986
857	P. M. Mohite	India	M.Tech-Ph.d	AE	2001, 2007
858	P. Venkataraman	United States	B.Tech	AE	1974
859	Padma Jyoti	Nepal	B.Tech	ME	1969
860	Pallav Priyadarshi	United States	B.Tech	CSE	2012
861	Pankaj A Apte	India	M.Tech	CHE	2000
862	Pankaj Arora	India	B.Tech	CHE	1985
863	Pankaj Kumar Gupta	India	B.Tech	CHE	1999
864	Pankaj Kumar Singh	India	B.Tech	EE	2014
865	Pankaj Mittal	India	B.Tech	CSE	1999
866	Pankaj Singh	India	B.Tech	ME	1995
867	Pankaj Singh Gautam	United States	B.Tech	CHE	1999
868	Pankaj Tanwar	United States	B.Tech	ME	2007
869	Paramita Bhattacharya	India	M.Tech	CE	2008
870	Parasar Mohanty	India	Ph.D	MTH	2001
871	Paritosh Kasliwal	United States	MSc2	PHY	1968
872	Parnika Agrawal	United States	B.Tech	MME	2012
873	Pawan Sheel Bhatnagar	United States	B.Tech	CSE	1985
874	Peter Manezes	United States	B.Tech	MME	1970
875	Phani Saripella	United States	B.Tech	EE	1988
876	Piyush Arora	India	B.Tech	ME	1989
877	Piyush Chandra	India	B.Tech	CHE	1985
878	Piyush Dharnidharka	India	MSc5	MTH	2014
879	Piyush Kumar	India	B.Tech	MME	1999
880	Prabhakar Tewari	United Kingdom	B.Tech	CE	1967
881	Prabhat Kumar Ravi	India	B.Tech	CE	2014

882	Pradeep Gaur	India	B.Tech	EE	1980
883	Pradeep Jain	United States	B.Tech	ME	1979
884	Pradeep Kumar Mittal	India	B.Tech	ME	1970
885	Pradeep Kumar Singh	United States	Ph.D	CHM	2010
886	Pradeep Tewari	India	B.Tech- M.Tech	CE	1976, 1980
887	Pradip D Parikh	India	B.Tech	ME	1980
888	Pradipta Bandyopadhyay	India	MSc2	CHM	1994
889	Prakash Awasthy	India	M.Tech	EE	2008
890	Prakash Deep Verma	India	MSc5	PHY	2001
891	Prakash Tiwari	India	B.Tech	CE	2014
892	Pramod Dayal	United Arab Emirates	B.Tech	MME	1969
893	Pramod L Vaishampayan	India	B.Tech	EE	1972
894	Pranav Vaish	United States	B.Tech	CSE	2017
895	Pranshu Gupta	United States	B.Tech	CSE	2017
896	Prashant Bajpai	India	B.Tech	CHE	1999
897	Prashant Gupta	India	B.Tech	BSBE	2014
898	Prashant Jalan	United States	B.Tech	CSE	2015
899	Prashant Kamal	India	B.Tech	MME	2001
900	Prashant Khatri	India	MSc5	PHY	2015
901	Prasoon Nigam	India	B.Tech	EE	2001
902	Prateek Bhansali	India	B.Tech	EE	2007
903	Prateek Singh	India	BT-MT(Dual)	ME	2015
904	Prateek Sircar	India	MSc5	MTH	2008
905	Pratik Chaplot	India	B.Tech	CHE	2013
906	Pratik Mayur Parekh	United States	B.Tech	ME	2012
907	Pratik Nayek	Singapore	M.Tech	CSE	2016
908	Pratul Kumar Choudhary	India	M.Tech	CE	1985
909	Pratyush	United States	B.Tech	CE	2007
910	Praveen Chandra	India	B.Tech	ME	2007
911	Praveen Goyal	India	B.Tech	EE	1989
912	Praveen K V	India	M.Tech	CSE	1996

913	Pravin Kumar	India	MSc5	MTH	1990
914	Preeti Goel	United States	M.Tech	CSE	2005
915	Premanand Sinha	India	B.Tech	MME	1970
916	Prinshul Jain	India	BT-MT(Dual)	CSE	2008
917	Prishati Raychowdhury	India	BT-MT(Dual)	CSE	2008
918	Priya Gole	United States	B.Tech	CSE	2024
919	Priya Modi	India	B.Tech	CHE	2014
920	Priyanka Kumari	United States	B.Tech	EE	1999
921	Priyanshu Gupta	India	B.Tech	EE	2021
922	Pulkit Jain	India	B.Tech	CSE	2014
923	Puluck Prakash	India	BT-MT(Dual)	ME	2015
924	Puneet Gupta	India	MSc5	CHM	2008
925	Puneet Ranjan	Singapore	B.Tech	EE	1990
926	Puneet Tandon	India	B.Tech	ME	1990
927	Punit Chandra	United States	B.Tech	EE	1999
928	Punit Kumar Pragati	United States	B.Tech	CHE	1999
929	Purnendu Bose	India	M.Tech	CE	1988
930	R K Lakhanpal	India	B.Tech	CE	1980
931	R Saravanan	United States	MSc5	PHY	1986
932	R Vijaya Kumar	India	M.Tech	ME	1984
933	Rachna Agarwal	India	B.Tech	MME	2007
934	Radha Krishna Singuru	India	M.Tech	CSE	1996
935	Radha Raman Gargeya	United States	M.Tech	EE	1978
936	Radhit Dedania	United States	BT(Double Major)	EE-CSE	2020
937	Raghavendra V	India	Ph.D	MTH	1973
938	Raghu Nayyar	India	B.Tech	EE	1980
939	Rahul Dixit	India	B.Tech	ME	1999
940	Rahul Jain	United States	B.Tech	EE	2007
941	Rahul Ratan	United States	B.Tech	EE	2000
942	Raj Kumar Jain	India	B.Tech	AE	1971
943	Raj Kumar Kapoor	India	B.Tech	CHE	1971

944	Raj Kumar Seth	India	B.Tech	EE	1972
945	Raj Shekhar	United States	B.Tech	EE	1989
946	Raj Yadav	United States	B.Tech	MME	2007
947	Rajan Gupta	United States	B.Tech	CSE	1999
948	Rajat	United States	M.Tech	CSE	2019
949	Rajat Bansal	India	B.Tech	EE	1985
950	Rajat Mittal	United States	B.Tech	AE	1989
951	Rajeev Bansal	United States	B.Tech	EE	1976
952	Rajeev Chopra	India	B.Tech	MME	1985
953	Rajeev Goel	Singapore	B.Tech	ME	1989
954	Rajeev Gupta	United States	B.Tech	MME	1997
955	Rajeev Jain	United States	B.Tech	CHE	1991
956	Rajeev Rao	India	MSc5	PHY	1994
957	Rajeev Thakur	India	B.Tech	CHE	1990
958	Rajeeva Kumar	United States	B.Tech- M.Tech	AE	1989, 1991
959	Rajendra Kumar Netam	India	B.Tech	MSE	2015
960	Rajesh Gupta	India	B.Tech	ME	1989
961	Rajesh Kumar Arora	United States	B.Tech	EE	1989
962	Rajesh Piplani	India	B.Tech	CHE	1985
963	Rajit Gadh	United States	B.Tech	ME	1984
964	Rajiv Dhingra	United States	B.Tech	EE	1980
965	Rajiv Dutta	United States	B.Tech	EE	1989
966	Rajiv Sahay	India	B.Tech	ME	1970
967	Rajiv Shanti Swarup	India	B.Tech	EE	1973
968	Rajiv Shekhar	India	B.Tech	MME	1982
969	Rajiv Verma	India	B.Tech	CSE	1989
970	Rajiva Srinivas Chakravarti	India	MSc2	MTH	1974
971	Rajive Joshi	United States	B.Tech	EE	1989
972	Rajneesh	India	B.Tech	ME	2000
973	Rajnish Shrivastava	India	B.Tech	EE	1989
974	Rakesh Agarwal	India	M.Tech	EE	2010

975	Rakesh Dhoopar	United States	B.Tech	MME	1985
976	Rakesh Kumar	India	B.Tech	AE	1985
977	Rakesh Kumar Saraf	Australia	M.Tech	IME	1989
978	Rakesh Pandey	United States	B.Tech	ME	1978
979	Rakesh Sharma	United States	M.Tech	NET	1978
980	Rakesh Soni	India	B.Tech	CHE	1974
981	Rakesh Surapaneni	United States	B.Tech	CSE	2011
982	Rakesh Surie	United States	B.Tech	EE	1973
983	Rakesh Tripathi	United States	B.Tech	MME	1988
984	Rakshit Kachhal	India	B.Tech	ME	2007
985	Ram Chet	India	B.Tech	EE	2000
986	Ram Misra	United States	B.Tech	ME	1968
987	Ram Tewari	United States	B.Tech	CE	1969
988	Ramachandran C N	India	Ph.D	CHM	2008
989	Ramamurthy Vaidhyathan	United States	B.Tech	CSE	1985
990	Ramasamy Vijaya Anand	India	Ph.D	CHM	2003
991	Ramesh Pathak	United States	B.Tech	ME	1990
992	Raminder Singh Ahlawat	United States	B.Tech	ME	1991
993	Randeep Bhasin	India	B.Tech	ME	1985
994	Ranjan Kumar Basak	India	Ph.D	CHM	2010
995	Ratna Shankar	India	MSc2	MTH	1999
996	Ratnadeep Joshi	India	B.Tech	CE	1989
997	Raunak Kumar	India	M.Tech	CSE	2021
998	Ravi Kant Mishra	India	B.Tech	ME	1976
999	Ravi Mishra	India	B.Tech	MME	2007
1000	Ravi Shekhar Sinha	India	B.Tech	CE	1985
1001	Ravi Tandon	United Kingdom	B.Tech	CHE	1972
1002	Ravi Teja Sukhavasi	United States	B.Tech	EE	2007
1003	Ravin Kulshrestha	India	B.Tech	ME	1985
1004	Ravindra Auluck	India	B.Tech	ME	1974
1005	Ravindra Karnad	India	B.Tech	EE	1981

1006	Ravindra Prakash	United States	B.Tech- M.Tech	EE	1973, 1975
1007	Richa Agarwal	United States	MSc5	MTH	2000
1008	Riju Singhal	India	B.Tech	CHE	2007
1009	Riptapan Singh	United States	B.Tech	EE	1973
1010	Rishabh Chandra	United States	B.Tech	EE	1995
1011	Rishi Kohli	India	B.Tech	ME	1999
1012	Rishikesha T Krishnan	India	MSc5	PHY	1986
1013	Rita Singh	India	B.Tech	MME	1985
1014	Rohit Aggarwal	India	B.Tech	EE	2007
1015	Rohit Gupta	India	B.Tech	CSE	2007
1016	Rohit Karan	India	B.Tech	EE	2007
1017	Rohit Kumar Agrawalla	United States	M.Tech	CSE	2010
1018	Rohit Kumar Bishnoi	India	B.Tech	CE	2008
1019	Rohitash Gupta	India	B.Tech	EE	1995
1020	Rudra Pratap Singh	India	M.Tech	CHE	2004
1021	Rupal Mishra	India	B.Tech	AE	2007
1022	S Arun Kumar	India	B.Tech	ME	1980
1023	Sachin Anand	United States	B.Tech	EE	1999
1024	Sachin Garg	India	BT-MT(Dual)	EE	2008
1025	Sachin Mittal	United States	B.Tech	MME	1999
1026	Sadhna Shah	India	Ph.D	CHM	2022
1027	Safir Ahmad	India	B.Tech	MME	2007
1028	Sahil Agrawal	India	M.Tech	CE	2024
1029	Sahil Grover	United States	B.Tech	CSE	2017
1030	Sahil Kajal	India	BT-MT(Dual)	ME	2015
1031	Saket Trivedi	United Kingdom	B.Tech	CHE	1999
1032	Salman Ahmad Khan	United States	BT-MT(Dual)	CHE	2016
1033	Samir Biswas	India	B.Tech	EE	1981
1034	Samrat Roy Choudhury	India	MBA	IME	2018
1035	Sandeep Jain	United States	B.Tech	CSE	1999

1036	Sandeep Khurana	India	B.Tech	EE	1985
1037	Sandeep Kothari	India	B.Tech	AE	1995
1038	Sandeep Kushwaha	India	BT-MT(Dual)	ME	2008
1039	Sandeep Mishra	India	MSc2	CHM	1992
1040	Sandeep Sangal	India	B.Tech	MME	1982
1041	Sandeep Shinde	India	B.Tech	MME	2007
1042	Sanjay Ghatare	United States	B.Tech- M.Tech	CSE	1989, 1992
1043	Sanjay Goel	United States	B.Tech	EE	1985
1044	Sanjay Jain	India	B.Tech	EE	1980
1045	Sanjay Karkhanis	India	B.Tech	MME	1986
1046	Sanjay Kukreja	India	B.Tech	EE	1995
1047	Sanjay Kumar	India	B.Tech	CE	1999
1048	Sanjay Kumar Chauhan	India	B.Tech	CSE	1985
1049	Sanjay Kumar Jain	India	M.Tech	CSE	2003
1050	Sanjay Kumar Singh	India	B.Tech	CE	1995
1051	Sanjay Kumar Sinha	India	B.Tech	ME	1983
1052	Sanjay Mittal	India	B.Tech	AE	1988
1053	Sanjay Pant	India	B.Tech	ME	2007
1054	Sanjay Saxena	United States	B.Tech	AE	1982
1055	Sanjay Shankar Jadhav	India	MBA	IME	2003
1056	Sanjay Tripathi	United States	MSc5	PHY	1990
1057	Sanjeev Garg	India	M.Tech	CHE	1997
1058	Sanjeev Kumar Mishra	United States	B.Tech	AE	1999
1059	Sanjeev Madan	United States	B.Tech	CHE	1982
1060	Sanjeev Sanghi	India	B.Tech	ME	1985
1061	Sanjiv Bhasin	Australia	B.Tech	EE	1985
1062	Sanjiv Manifest	United States	B.Tech	EE	1978
1063	Sanjiv Rangrass	India	B.Tech	ME	1982
1064	Sankrant Sanu	United States	B.Tech	CSE	1989
1065	Sant Kumar Yadav	India	B.Tech	CE	1965

1066	Santanu De	India	M.Tech	ME	2004
1067	Santosh H S	United States	MSc5	PHY	1995
1068	Saptarshi Mukherjee	India	M.DES	DES	2023
1069	Sarthak Rout	India	B.Tech	CSE	2023
1070	Satish Chand Gupta	India	B.Tech	CHE	1969
1071	Satish Kumar	United States	B.Tech	ME	1999
1072	Satish Kumar Misra	India	B.Tech	ME	1985
1073	Satnam Arora	India	MSc2	MTH	1999
1074	Satvik Jain	India	BT-MT(Dual)	EE	2023
1075	Satya Narayan Zindal	India	M.Tech	EE	1972
1076	Satyavolu Sai Nitish	United States	BT-MT(Dual)	EE	2016
1077	Satyendra Yadav	India	B.Tech	CHE	2015
1078	Saumyen Guha	India	M.Tech	CE	1989
1079	Saurabh	India	M.Tech	ME	2020
1080	Saurabh Agarwal	United States	B.Tech	CE	2004
1081	Saurabh Khanna	India	B.Tech	MME	2007
1082	Saurabh Maheshwari	United States	B.Tech	EE	1999
1083	Saurabh Mittal	India	MSc5	MTH	2015
1084	Saurabh Prasad	India	B.Tech	AE	1999
1085	Saurabh Ranjan	India	BT-MT(Dual)	ME	2020
1086	Saurabh Shresth	India	MSc2	CHM	1995
1087	Saurabh Srivastava	United States	B.Tech	CHE	1999
1088	Saurabh Tiwary	United States	B.Tech	EE	2001
1089	Seshadri C Sivasubramanian	India	Ph.D	CHM	1989
1090	Seshashayee Murthy	United States	B.Tech	EE	1979
1091	Shagun Srivastava	India	MS-R	CHE	2024
1092	Shailendra Nath Agarwal	India	B.Tech	ME	1969
1093	Shailesh Kumar	India	B.Tech	ME	1999
1094	Shailesh Nigam	India	B.Tech	CHE	1985
1095	Shakti Gupta	United States	B.Tech	CHE	1999

1096	Shalabh Chandra	India	B.Tech	EE	1989
1097	Shankar Iyer	United States	B.Tech	EE	1982
1098	Shankar Prawesh	India	MSc5	MTH	2009
1099	Shanta Mishra	India	MSc2	MTH	1999
1100	Shanti Gopal Patra	India	MSc2	CHM	2012
1101	Sharad Singhal	United States	B.Tech	EE	1977
1102	Sharad Sinha	Spain	B.Tech	ME	2008
1103	Sharmishtha Mitra	India	MSc2-Ph.d	STAT	1991, 1997
1104	Shashwat Mishra	India	B.Tech	CHE	2014
1105	Sheelendra Rai Vidyarthi	India	B.Tech	CHE	1973
1106	Shekhar Swarup Rajvanshy	United States	B.Tech	EE	1985
1107	Shekhar Varma	India	B.Tech	EE	1985
1108	Shiv Kumar Pachori	United States	B.Tech	EE	1993
1109	Shivam Pandey	India	B.Tech	ME	2024
1110	Shivanand Baad	Australia	M.Tech	EE	1993
1111	Shiwansh Rai	India	B.Tech	AE	2019
1112	Shoan Jain	United States	BS	ECO	2015
1113	Shobhit Chauhan	United States	B.Tech	CE	1995
1114	Shobhit Srivastava	India	B.Tech	CE	2007
1115	Shourya Soni	India	B.Tech	AE	2020
1116	Shourya Umang	India	B.Tech	AE	2016
1117	Shreyan Chowdhury	Austria	BT-MT(Dual)	EE	2015
1118	Shreyasi Mandal	India	B.Tech- M.Tech	CSE	2024, 2023
1119	Shriram Bagrodia	United States	B.Tech	CHE	1973
1120	Shubhdeep Kochhar	United States	BT-MT(Dual)	CSE	2015
1121	Shweta Tomar	India	B.Tech	EE	2007
1122	Shyam Sharma	United States	B.Tech	EE	1999
1123	Shyamalesh	India	B.Tech	CSE	1987
1124	Shyamasundar Kaluve	India	M.Tech	CSE	1998
1125	Siddharth Dasgupta	United States	MSc5	CHM	1980

1126	Siddharth Jain	United Kingdom	BT-MT(Dual)	CSE	2008
1127	Siddharth Sharma	United States	B.Tech	EE	1999
1128	Siddhartha Shankar Roy	India	B.Tech	CHE	1995
1129	Sivananda Thancanamootoo	United Kingdom	B.Tech	CE	1981
1130	Sneha Dattatraya Thube	United States	MSc5	ECO	2015
1131	Sohil Bansal	India	BT-MT(Dual)	ME	2017
1132	Soumen Mandal	India	MSc-PhD(Dual)	PHY	2009
1133	Soumya Banerjee	India	B.Tech	EE	1999
1134	Sourabh Kumar Varma	India	B.Tech	ME	1999
1135	Sourav Maji	United States	B.Tech	EE	1999
1136	Sreejith Nadakkal Appukuttan	United States	M.Tech	AE	2011
1137	Sreeram Kishore Chavali	United States	M.Tech	CHE	1994
1138	Srikanth Myskar	United States	B.Tech	EE	2013
1139	Srinivas Garimella	United States	B.Tech	ME	1982
1140	Sriram Gorti	India	M.Tech	CSE	1998
1141	Sristi Jaiswal	India	M.Tech	CSE	2021
1142	Subhash Chandra Rajak	India	B.Tech	CE	1985
1143	Subhash Sanjay	United States	B.Tech	EE	1989
1144	Subir Bagchi	India	B.Tech	CHE	1971
1145	Subir Kohli	India	B.Tech	ME	1999
1146	Subodh Kumar Chaturvedi	India	B.Tech	ME	1969
1147	Subodh Prabhakar Yeotikar	India	M.Tech	EE	1985
1148	Sudarshan Kumar Bhutra	United States	B.Tech	CHE	1975
1149	Sudeep Mehrotra	India	B.Tech	EE	2007
1150	Sudhanshu	India	BT-MT(Dual)	EE	2008
1151	Sudhanshu Jaiswal	India	B.Tech	EE	2020
1152	Sudhir Gejji	United States	B.Tech	CHE	1973
1153	Sudhir Jhaveri	India	B.Tech	CHE	1975
1154	Sudhir Kumar	United States	B.Tech	EE	1985

1155	Sudhir Kumar Sinha	United States	Ph.D	CHM	1972
1156	Sudhir Misra	India	B.Tech	CE	1981
1157	Sudhir Satpathy	India	B.Tech	EE	2007
1158	Sudipta Kanti Haldar	United States	B.Tech	CSE	1995
1159	Sugato Basu	India	B.Tech	ME	1989
1160	Sujay Chattopadhyay	India	M.Tech	CHE	1994
1161	Sukanta Nanda	United States	B.Tech- M.Tech	EE	1985, 1989
1162	Sukanta Saha	India	B.Tech	EE	1985
1163	Sumit Ganguly	India	B.Tech	CSE	1987
1164	Sumit Mukherjee	United States	B.Tech	CHE	1991
1165	Sundeep Bhatia	United States	B.Tech	AE	1985
1166	Suneel Kapur	India	B.Tech	ME	1969
1167	Sunil Gupta	UAE	B.Tech	ME	1980
1168	Sunil Jain	India	B.Tech	CSE	1999
1169	Sunil James	United States	B.Tech	AE	1990
1170	Sunil Kumar	India	B.Tech	EE	1985
1171	Sunil Kumar Ram	India	M.Tech	IME	1990
1172	Sunil Kumar Sabharwal	India	B.Tech	EE	1970
1173	Sunil Shende	United States	B.Tech	CSE	1984
1174	Sunny Bajaj	India	B.Tech	MME	2004
1175	Suprotik Das	India	B.Tech	MME	1974
1176	Surendra Singh Yadav	India	B.Tech	CHE	1978
1177	Suresh Kumar	India	B.Tech	ME	1980
1178	Suresh Pandey	India	B.Tech	MME	1965
1179	Suresh Prasad Rastogi	India	B.Tech	CHE	1969
1180	Surojit Sen	India	B.Tech	MME	1970
1181	Surya Kanta Brahma	India	B.Tech	ME	1989
1182	Susanta Mahapatra	India	PhD	CHM	1996
1183	Sushil Ranjan	United States	B.Tech	MME	1990

1184	Sushim Shah	United States	B.Tech	CHE	1974
1185	Suyash Verma	India	B.Tech	CE	2023
1186	Swapnil Agarwal	United States	B.Tech	MSE	2014
1187	Swapnil Bhaskar	India	B.Tech	CHE	2007
1188	Swapnil Raykar	India	M.Tech	CSE	2020
1189	Swarup Kumar Mohalik	India	B.Tech- M.Tech	CSE	1990, 1992
1190	Swati Tiwari	India	BT-MT(Dual)	EE	2015
1191	Syed Aman	United States	B.Tech	CHE	2000
1192	T J Manjunath	United States	M.Tech	CSE	1994
1193	T Ravichandran	India	M.Tech	LTP	2005
1194	Tabish Naseem Zaidi	United States	B.Tech	CHE	1990
1195	Tanu Malik	United States	B.Tech	CE	1999
1196	Tanuj Patel	India	BT-MT(Dual)	CE	2015
1197	Tapan Panda	United States	B.Tech- M.Tech	MME	1990, 1996
1198	Tapesh Kumar Agarwal	India	B.Tech	EE	1999
1199	Tarun Kumar Kayal	India	B.Tech	CHE	1985
1200	Tarun Raj	India	B.Tech	EE	1999
1201	Tejvir Singh	India	B.Tech	CE	2014
1202	Thomas George	United States	B.Tech	EE	1969
1203	Triloki Nath Agarwal	India	B.Tech	MME	1969
1204	Tushar Dilip Patil	India	M.Tech	SEE	2023
1205	Tushar Rajpathak	India	M.Tech	ME	1996
1206	Tushar Soni	India	B.Tech	CHE	2024
1207	Uday Shankar	India	B.Tech-M.Tech	CHE	1990, 1993
1208	Ujjwal Varshney	India	B.Tech	MSE	2019
1209	Ullas Sharma	India	B.Tech	EE	1985
1210	Umang Agarwal	United States	B.Tech	CHE	2007
1211	Umesh Chandra Joshi	India	B.Tech	CE	1999
1212	Umesh Ratnam	United States	B.Tech	CHE	1985

1213	Umesh Sharraf	India	B.Tech	ME	1985
1214	Unmesh Ratnam	United States	B.Tech	CHE	1985
1215	Upal Roy	India	B.Tech	MME	1989
1216	Upendra Singh Rohatgi	United States	B.Tech	ME	1970
1217	Utsav Kumar	India	B.Tech	EE	2014
1218	Utsaw Kumar	United States	B.Tech	EE	2007
1219	V Hariharasubramanian	India	Ph.D	CHM	1979
1220	V. M. & Associates (Sanjay Bajaj)	India	B.Tech	CHE	1985
1221	Vaibhav Bhagat	India	B.Tech	ME	2018
1222	Varun Agrawal	India	B.Tech	EE	2010
1223	Varun Gupta	India	B.Tech	CHE	1998
1224	Varun Jain	India	B.Tech	EE	2009
1225	Varun Mishra	Singapore	BT-MT(Dual)	CSE	2011
1226	Varun Vashishtha	United States	B.Tech	CHE	2007
1227	Vathyam Krishna	Canada	B.Tech	EE	1985
1228	Ved Prakkash Sharma	India	B.Tech	EE	1985
1229	Veena Bansal	India	Ph.D	CSE	1999
1230	Veer Singh Meena	India	B.Tech	BSBE	2014
1231	Vibhash Upadhyaya	India	B.Tech	AE	1990
1232	Vibhu Sen Agarwal	India	B.Tech	CE	1985
1233	Vijai Kumar Jain	United States	B.Tech	CE	1966
1234	Vijay Krishna Gupta	India	B.Tech	CSE	1985
1235	Vijay Kumar	United States	B.Tech	ME	1983
1236	Vijay Kumar Sethi	India	B.Tech	ME	1969
1237	Vijay Maurya	India	B.Tech	CE	2023
1238	Vikas Bansal	India	M.Tech	EE	2024
1239	Vikas Jindal	India	B.Tech	MME	1999
1240	Vikas Juneja	United States	B.Tech	ME	1989
1241	Vikram Dayal	United States	B.Tech	AE	1980

1242	Vikram Rathi	India	B.Tech	CSE	2015
1243	Vikrant Joshi	United States	M.Tech	CE	1987
1244	Vimal Kumar Srivastava	Switzerland	B.Tech-M.Tech	ME	1990, 1992
1245	Vinai Kumar Gupta	India	B.Tech-Ph.d	MME	1969, 1976
1246	Vinay Agrawal	India	B.Tech	AE	1985
1247	Vinay Khanna	United States	B.Tech	ME	1970
1248	Vinay Kumar	India	B.Tech	CE	2002
1249	Vinay Kumar Bassi	India	B.Tech	CE	2002
1250	Vinay Kumar Shukla	United States	B.Tech	CE	1989
1251	Vinay Viswanath Peshwa	India	B.Tech	CHE	1995
1252	Vinaya Varma	India	B.Tech	MME	1990
1253	Vineet Gupta	United States	BT-MT	CSE	1989, 1995
1254	Vineet Kumar Gupta	United States	B.Tech	CHE	1999
1255	Vineet Singh Gupta	United States	BT-MT	CSE	1989, 1995
1256	Vineeth Kumar Paleri	India	M.Tech	CSE	1986
1257	Vinod Baya	United States	B.Tech	ME	1987
1258	Vinod Kumar	India	B.Tech	CSE	1985
1259	Vinod Tare	India	M.Tech-Ph.d	CE	1978, 1981
1260	Vipin Agarwal	United States	B.Tech	CHE	2003
1261	Vipin Kumar	India	B.Tech	EE	2010
1262	Vipin Mangal	India	M.Tech	EE	2006
1263	Vipul Katyal	United States	B.Tech	EE	2000
1264	Viraf Khursheed Hathiram	Australia	B.Tech	EE	1985
1265	Vishal Kumar	India	B.Tech	MME	1999
1266	Vishal Kumar Agarwal	India	B.Tech	CE	1999
1267	Vishal Rai	Canada	B.Tech	EE	1999
1268	Vishal Sharan	India	M.Tech	PSE	2019
1269	Vishal Sharma	United States	B.Tech	CSE	1999
1270	Vishal Varshney	India	B.Tech	EE	1999

1271	Vivek Gupta	India	B.Tech	BSBE	2014
1272	Vivek Kumar	India	B.Tech	EE	2007
1273	Vivek Madhani	India	BT-MT(Dual)	CHE	2008
1274	Vivek Mannige	India	B.Tech	MME	1974
1275	Vivek Mathur	India	B.Tech	ME	1985
1276	Vivek Pandey	India	B.Tech	CSE	2003
1277	Vivek Tandon	United States	B.Tech	CSE	1999
1278	Viveka Kulharia	United States	B.Tech	CSE	2016
1279	Wilson Jacob	India	Ph.D	CHM	2007
1280	Yadavalli Sitaram	United States	B.Tech-M.Tech	EE	1989, 1991
1281	Yajnaman Tamrakar	Nepal	B.Tech	CE	1969
1282	Yashwant Gupta	India	B.Tech	EE	1985
1283	Yogesh Chandra Garg	India	B.Tech	EE	1974
1284	Yogesh Chandra Khosla	Singapore	B.Tech	CHE	1974
1285	Yogesh K Rathore	India	B.Tech	ME	1995
1286	Yugal Sahu	United States	M.Tech	EE	2009
1287	Ziaul Hasan Hashmi	United States	B.Tech	EE	2005

ALL TOP DONORS (NON-ALUMNI)

1-5 Crores		
S. No.	Donor Name	Country
1	The Mehta Family Foundation	United States
2	Chandralekha Singh & Jeremy Levy	United States
3	Vikram Tannan	India
11 - 99 Lakh		
4	Karmakar Foundation	India
5	Satish Agarwal	United States
6	Jahnvi Sharma	United States

1 - 10 Lakhs

S. No.	Donor Name	Country
7	Shraman Foundation	United States
8	Ajay Gupta	United States
9	Alex Combs	United States
10	Arjun Israni	United States
11	Arvind Kumar	United States
12	Ashish Agrawal	India
13	B. A. Bhanu Prasad	United States
14	Chandrika Raina	India
15	Dattatraya Dethe	India
16	Deebu Vats	United States
17	Deepak Chhibba	India
18	Diwan Singh Rawat	India
19	Dootika Vats	India
20	Harjeet Singh Nalwa	India
21	J S Yadav	India
22	Mahesh Chandra Agrawal	India
23	Mahesh Tandon	India
24	Manoj Gupta	United States
25	Mukul Kumar Gupta	India
26	Nirmal Kishore Jain	India
27	Nitin T. Patil	India
28	Parikshit Gupta	United States
29	Parthasarathy Saravanan	United States
30	Pranav Agarwal	India
31	Raja Angamuthu	India
32	Rajesh Srivastava	India
33	Rama Agrawal	India
34	Ratish Chandra Pandey	India

35	Ravi Aggarwal	United States
36	Robert Reitherman	United States
37	Shubham Gupta	United States
38	Srinivas Mantrala	India
39	Vijaya Ramarao	India
40	Zafar Hasan	United States

Less than 1 Lakh		
S. No.	Donor Name	Country
41	A V Ravishankar Sarma	India
42	Aakash Kumar	India
43	Aamir Akhtar	India
44	Abhas Singh	India
45	Abhijit Kushari	India
46	Addepalli Venkata Bhaskara Rao	India
47	Aditi Munmun Sengupta	India
48	Aditya Gupta	India
49	Akanksha Loomba	India
50	Alakesh Bisai	India
51	Alok Kumar Maloo	India
52	Amalendu Chandra	India
53	Aman Singh	United States
54	Amaresh S Patil	India
55	Amit Kumar Basu	India
56	Amitabha Bandyopadhyay	India
57	Anand Kumar Bachhawat	India
58	Anand Singh	India
59	Anantharaman Ganapathi	India
60	Anil Kumar Verma	India
61	Anil Seth	India
62	Animesh Biswas	India
63	Animesh Das	India
64	Anindita Chakrabarti	India
65	Anindya Chatterjee	India
66	Anjan Kumar Dutta	India
67	Anju Dixit	India
68	Ankit Kumar Tripathi	India
69	Ankur Gupta	United States

70	Ankur Jain	India
71	Anoop Singh	India
72	Anupam Saxena	India
73	Anuradha Pandey	India
74	Anurag Sah	India
75	Ark Verma	India
76	Arnab Bhattacharya	India
77	Arti Sharma	India
78	Arun Suneja	Canada
79	Arvind Mathur	India
80	Ashok Kumar	India
81	Ashwani Kumar Tiwari	India
82	Avinash Singh	India
832	B V Rathish Kumar	India
84	B.V. Phani	India
85	Bharat Lohani	India
86	Binay Kumar Pattnaik	India
87	Bishakh Bhattacharya	India
88	Braj Bhushan	India
89	Brajesh Pande	India
90	C S Upadhyay	India
91	Chandra Shekhar Patel	India
92	Chetna Chauhan	India
93	Debasis Roy	India
94	Deepak Bhogilal Dave	India
95	Dhanvir Singh Rana	India
96	Dhirendra S Katti	India
97	Divakar Jaiswal	India
98	Divyanshu Singh	India
99	Dubraj Das	India
100	Durgesh C Rai	India

101	G Shree Lakshmi	India
102	G. Kumaresan	India
103	Gandhreti Tanuja	India
104	Gaurav Maroo	India
105	Gautam Biswas	India
106	Ghanshyam Pandey	India
107	Gobinath Velusamy	India
108	Gokul Chandra Mondal	India
109	Gopesh Tiwari	India
110	Gyan Prakash Bajpai	India
111	Hari Krishna Kodali	United States
112	Hari Kumar	India
113	Harish Rupakula	India
114	Harshit Bajpai	India
115	Harshit Joshi	United States
116	I S Sarma	United States
117	Indra Pal Singh	India
118	Indra Sekhar Sen	India
119	Jitendra Bera	India
120	Jonaki Sen	India
121	Joydeep Dutta	India
122	Jyoti Jain	United States
123	Kallol Mondal	India
124	Kamal Poddar	India
125	Kapil Kaul	India
126	Kartikeya Misra	India
127	Kasturi Vasudevan	India
128	Keshav Kapoor	India
129	Khaleeque Ahmad	India
130	Khushi	India
131	Koumudi Patil	India

132	Krishanu Biswas	India
133	Laxmidhar Behera	India
134	Lekh Raj Singh	India
135	M. L. N. Rao	India
136	Madhumita Mukherjee	India
137	Mahendra Kumar Verma	India
138	Mainak Chaudhuri	India
139	Malay Singh	United States
140	Manas Kumar Ghorai	India
141	Manikonda Laxmi Narasimha Rao	India
142	Manish Kumar Srivastava	India
143	Mehul Rasiklal Shah	India
144	Mihir Mishra	India
145	Milon Mohan Sadhu	United States
146	Mrunal	India
147	Mukesh Kumar Barua	India
148	Murali Prasad Panta	India
149	N. Subramanian	India
150	Namrata Rastogi	India
151	Nandini Gupta	India
152	Nandini Nilakantan	India
153	Nareshkumar Ratanshi Shah	India
154	Nihar Ranjan Patra	India
155	Nirmal K. Rana	India
156	Nisanth N. Nair	India
157	Nishpreet Kaur	India
158	Niyati Padhi	India
159	O R Jaiswal	India
160	Om Prakash Shah	India
161	Onkar Dikshit	India
162	P Joginaidu	India

163	P Shunmugaraj	India
164	Parthasarathi Sensarma	India
165	Phani Saripella	United States
166	Pradip Sinha	India
167	Pradipta Kumar Panigrahi	India
168	Prakashvel Jawahar	India
169	Prasad Panandikar	India
170	Prashant Bagad	India
171	Prashant Dubey	United States
172	Prateek Sachdeva	United States
173	Pratik Sen	India
174	Premanand Shenoy	India
175	Priyanka Ghosh	India
176	Priyaranjan Tiwari	India
177	Prof. Krishna Nand Singh	India
178	R Gurunath	India
179	R K Vishwakarma	India
180	R R K Sharma	India
181	Rabinder Shekher	India
182	Raghavan Varadarajan	India
183	Raghunath Tewari	India
184	Raghvendra Singh	India
185	Rahul Varman	India
186	Rajarshi Sengupta	India
187	Rajat Sharma	India
188	Rajendra Kulkarni	India
189	Rajendra Kumar Rai	India
190	Rajesh K. Singh	India
191	Rajib Kumar Goswami	India
192	Rajiv Sinha	India
193	Raju	India

194	Rakesh Kumar	India
195	Ramasubbu S Ramakrishnan	India
196	Ramesh Pardhiye	India
197	Ramesh Singh	India
198	Ravi Kumar Sharma	India
199	Ravi P. Singh	India
200	Rayhan G. Biswas	United States
201	Rekha Jhaveri	India
202	Ritik Ahirwar	India
203	S. Selvakumar	India
204	Sagar Chakraborty	India
205	Saicharan Booduguri	India
206	Saktipada Ghorai	India
207	Sandeep K. Dwivedi	India
208	Sandeep Verma	India
209	Sanjeev Koppal	United States
210	Sankar Prasad Rath	India
211	Sarani Saha	India
212	Satrajit Adhikari	India
213	Satyaki Roy	India
214	Shalabh	India
215	Shantanu Deshpande	United States
216	Sharmila Chatterjee	United States
217	Shashank Shekhar	India
218	Shaurya Singh	India
219	Sheetal Shah	India
220	Somesh Kumar Mathur	India
221	Subhas Chandra Misra	India
222	Suchitra Mathur	India
223	Sudhir Tyagi	India
224	Sumit Basu	India

225	Sunil Gandhi	India
226	Surendra Kumar Agnihotri	India
227	Suresh Singh	India
228	Tapas Das	India
229	Ubale Deepak Raghuvir	India
230	Uddipan Bagchi	India
231	Ujjwal Bhaskar	United States
232	Utkarsh Dwivedi	India
233	Utpal Das	India
234	V K Singh	India
235	Ved Bhushan Kail	India
236	Ved Prakash Dev	India
237	Vimal Kumar	India
238	Vinay Kumar Gupta	India
239	Vineet Sahu	India
240	Vipul Mathur	India
241	Vishnumaya Bisai	India
242	Viswanathan Shankar	India
243	Vivek Verma	India
244	Y N Mohapatra	India
245	Yatindra Nath Singh	India

ALL TOP DONORS (ORGANIZATIONS)

More than 10 Crores		
S. No	Donor Name	Country
1	IBM India Pvt. Ltd.	India
2	Kotak Mahindra Bank Ltd.	India
3	AIA Engineering Ltd. Mr. Bhadresh Shah (BT/ MME/1974)	India
4	Citadel Securities India Markets Private Limited	India

6 - 10 Crores		
S. No	Donor Name	Country
5	Citibank N.A.	India
1 - 5 Crores		
S. No	Donor Name	Country
6	J K Cement Ltd. Mr. Yadupati Singhania (BT/ CE/1977)	India
7	HDFC Bank	India
8	ICICI Foundation For Inclusive Growth	India
9	ITC Limited	India
10	REC Foundation	India
11	Portescap India Pvt. Ltd.	India
11 - 99 Lakhs		
S. No.	Donor Name	Country
12	Tower Research Capital Markets India Private Limited	India
13	Suraj Logistix Pvt. Ltd.	India
14	Nmtronics (India) Private Limited	India
15	IPM India Wholesale Trading Private Limited	India
16	Yuva Unstoppable	India
17	In Covid Support Fze Llc	India
18	TCS Fellowship	India
19	RIICO LTD	India
20	Adani Enterprises Limited	India
21	4E Software Private Limited Mr. Mahendra Yadav (BT/ ME/1999)	India
22	Airbus India Private Limited	India
23	Government Of Uttarakhand	India
24	MacDermid Alpha Electronics Solutions India Private Limited	India
25	Saraswati Heart Care & Research Centre Pvt Ltd Mr. Surendra Kumar Garg (BT/EE/1972)	India

26	ANSYS Software Private Limited	India
27	Faiveley Transport Rail Technologies India Pvt. Ltd.	India
28	Hindon Filters Pvt. Ltd. Mr. Madan Gopal Agarwal (BT/ME/1974)	India
29	Sahasra Electronics Pvt. Ltd. Mr. Ajit Chakravarti (BT/ EE/1972)	India
30	Qualtech Consultants Pvt. Ltd.	India
31	ZN Tech Solutions Pvt Ltd	India

1 - 10 Lakhs

S. No.	Donor Name	Country
32	Frontier Alloy Steel Ltd	India
33	Humboldt Wedeag	India
34	Pradeep Metals Limited	India
35	Sethi-Sethi Comf Mr. Satish sethi (BT/EE/1975)	India
36	Zopsmart Technology Pvt. Ltd.	India
37	Credex Technology Private Limited Mr. Pradeep Arya (MSc2/MTH-STAT/1999)	India
38	CSI Engineering Software Pvt. Ltd.	India
39	Logic Fruit Technologies Private Limited	India
40	Audify Tech Private Limited	India
41	Omidyar Network India Advisors Private Limited Mr. Siddharth Nautiyal - (B.Tech/CSE/1999)	India
42	Rahman Industries Limited	India
43	Hytech Professionals India Pvt Ltd Mr. Damnish Kumar (MSc5/MTH/2000)	India
44	Amogha Welfare Foundation	India
45	Fashion Suitings Private Limited	India
46	Radha Kishan Kanodia Dharmarth Trust	India
47	Aeron Systems Pvt. Ltd.	India
48	AlphaGrep Securities Pvt Ltd.	India
49	Bharat Forge Ltd.	India

50	Hexa Tours And Travels Private Limited	India
51	Integra Micro Systems Pvt. Ltd.	India
52	Khanna and Khanna Limited	India
53	PN International Pvt. Ltd.	India
54	PNC Infratech Ltd.	India
55	Prachi Leathers Pvt. Ltd Mr. Anil Gupta (BT/ME/1978)	India
56	Raramuri Technology Pvt. Ltd.	India
57	TVM Signalling And Transportation Systems Pvt. Ltd.	India
58	Wonder Illuminate Service Of Education Pvt. Ltd.	India
59	My Home Industries Pvt Ltd	India
60	Apollo Heat Exchangers Pvt. Ltd Mr. Naresh Shah (BT/ME/1974)	India
61	Bright 4 Wheel Sales Private Limited	India
62	Tellapur Technocity Private Limited	India
63	Continental Belting Pvt Ltd	India
64	J. K. Fenner (India) Limited	India
65	Jjg Aero Private Limited	India
66	Prem Jain Memorial Trust	India
67	Rimjhim Ispat Ltd.	India

Less than 1 Lakhs

S. No.	Donor Name	Country
68	Alkyl Amines Chemicals Limited	India
69	Evonik India Private Limited	India
70	My Home Power Consultancy Services Pvt Ltd	India
71	Surya Powerpacks Mr. Tarun Desai (BT/CHE/1978)	India
72	The Narayan Science Foundation	United States

LEADERSHIP DONORS



Mr. Rakesh Gangwal
(BT/ME/1975)



Mr. Narayana Murthy
(MT/EE/1969)



Dr. Dev Joneja
(BT/ME/1984)



Mr. Muktesh Pant
(BT/CHE/1976)



Mr. Anil Bansal
(BT/MME/1977)



Mr. Sudhakar Kesavan
(BT/CHE/1976)



Mr. Hemant Jalan
(BT/CHE/1977)



Dr. Late Ranjit Singh
(BT/MME/1965)

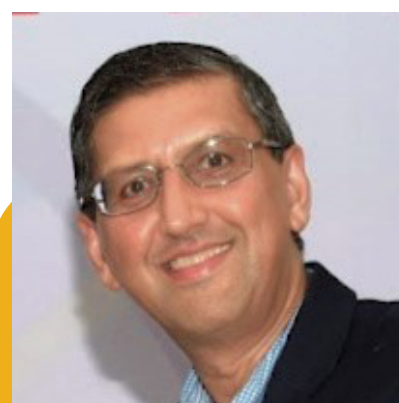

Mr. Rahul Mehta
(The Mehta Family Foundation)
Non-Alumni



Mr. Bhadresh Shah
(BT/MME/1974)



Mr. Vikram Tannan
(Non-Alumni)

PRINCIPAL DONORS



**Prof. Chandralekha
Singh & Jeremy Levy**
(non-alumni)

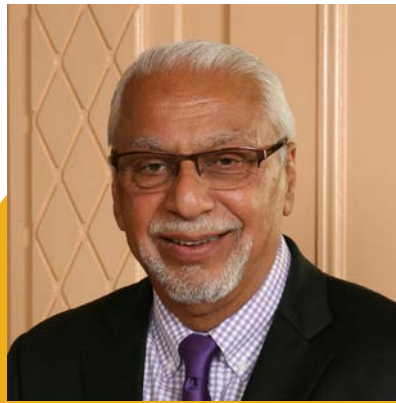

Mr. Jagjeet S. Bindra
(BT/CHE/1969)



Mr. Lokvir Kapoor
(BT/ME/1987)



Ms. Asha Jadeja
(non-alumni)



Dr. Prabhu Goel
(BT/EE/1970)



Ms. Nirmala Govindan
(MT/CSE/1987)

MAJOR DONORS

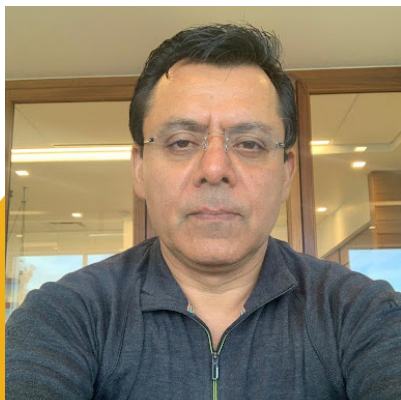

Mr. Pawan Tewari
(BT/EE/1988)



Mr. Ranodeb Roy
(BT/CSE/1990)



Dr. Deepak Mohan Narula
(BT/EE/1985)



Mr. Rajiv Batra
(BT/EE/1982)

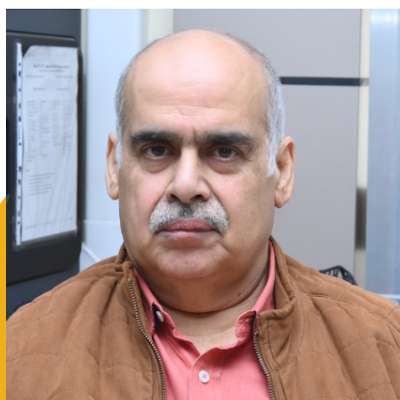

Mr. Ajay Dubey
(BT/CHE/1980)



Dr. Devendra Shukla
(BT/CE/1967)



Mr. Ashish Karandikar
(BT/EE/1995)



Mr. Kal Shastri
(MSc2/PHY/1976)



Late Mr. Kushal Sacheti
(MT/CHE/1971)



Mr. Sudhir Mohan Mittal (BT/CHE/1970)



Mr. Alok Agarwal (BT/EE/1979)



Dr. B V R Mohan Reddy (MT/ME/1974)



Prof. Jainendra Navlakha (MT/EE/1974)



Mr. Manas Mandal (BT/CSE/1985)



Dr. Rajeev Gautam (BT/CHE/1974)



Mr. Rao Remala (MT/CSE/1975)



Mr. Srinath Anantharaman (BT/EE/1980)



Mr. Pawan Kumar Goenka (BT/ME/1975)



Mr. Manoj Singh
(BT/EE/1974)



Mr. Ashutosh Garg
(BT/CHE/1974)



**Dr. Shishpal Singh
Rawat (BT/EE/1979)**

**Karmakar
Foundation**

(Non-alumni)



OUTREACH '69 & '80

स्वातंत्र्य संघ
१९६९-१९८०

केंद्र
दूर शिक्षण
१९६९-१९८०



Office of Resources and Alumni

Indian Institute of Technology Kanpur

Contact us

Dean of Resources and Alumni Office,
Third Floor, Faculty Building Annex, IIT Kanpur- 208016

dora_desk@iitk.ac.in | +91-512-259-7289
<https://www.iitk.ac.in/dora/>

Follow us on

